

1.1MHz, Precision, Rail-to-Rail I/O CMOS Operational Amplifier

FEATURES

- **HIGH GAIN BANDWIDTH:1.1MHz**
- **RAIL-TO-RAIL INPUT AND OUTPUT**
 $\pm 0.5\text{mV Max Vos (RS6331P, RS6332P)}$
 $\pm 0.8\text{mV Max Vos (RS6334P)}$
- **INPUT VOLTAGE RANGE: -0.1V to +5.6V**
with $V_s = 5.5\text{V}$
- **SUPPLY RANGE: +2.1V to +5.5V**
- **SPECIFIED UP TO +125°C**
- **Micro SIZE PACKAGES: SOT23-5, SC70-5**

APPLICATIONS

- **SENSORS**
- **PHOTODIODE AMPLIFICATION**
- **ACTIVE FILTERS**
- **TEST EQUIPMENT**
- **DRIVING A/D CONVERTERS**

DESCRIPTION

The RS6331P, RS6332P, RS6334P families of products offer low voltage operation and rail-to-rail input and output, as well as excellent speed/power consumption ratio, providing an excellent bandwidth (1.1MHz) and slew rate of 0.5V/us. The op-amps are unity gain stable and feature an ultra-low input bias current.

The RS6331P, RS6332P and RS6334P has lower offset, which is guaranteed not upper than $\pm 0.5\text{mV}$ (RS6331P, RS6332P) / $\pm 0.8\text{mV}$ (RS6334P) at 25°C with $V_s = 5\text{V}$, $V_{CM} = V_s/2$.

The devices are ideal for sensor interfaces, active filters and portable applications. The RS6331P, RS6332P, RS6334P families of operational amplifiers are specified at the full temperature range of -40°C to $+125^\circ\text{C}$ under single supplies of 2.1V to 5.5V or dual power supplies of $\pm 1.05\text{V}$ to $\pm 2.75\text{V}$.

Device Information ⁽¹⁾

PART NUMBER	PACKAGE	BODY SIZE(NOM)
RS6331P	SOT23-5	2.90mm×1.60mm
	SOP8	4.90mm×3.90mm
	MSOP8	3.00mm×3.00mm
	SC70-5	2.10mm×1.25mm
RS6332P	SOP8	4.90mm×3.90mm
	MSOP8	3.00mm×3.00mm
	TSSOP8	3.00mm×4.40mm
	DFN2X2-8	2.00mm×2.00mm
RS6334P	SOP14	8.65mm×3.90mm
	TSSOP14	5.00mm×4.40mm

(1) For all available packages, see the orderable addendum at the end of the data sheet.

Revision History

Note: Page numbers for previous revisions may differ from page numbers in the current version.

VERSION	Change Date	Change Item
C.2	2022/05/17	1. Update specification layout 2. Update Package Qty on Page 2@RevC.1 3. Added TAPE AND REEL INFORMATION 4. Added Detailed Description
C.2.1	2024/03/04	Modify packaging naming

Pin Configuration and Functions (Top View)

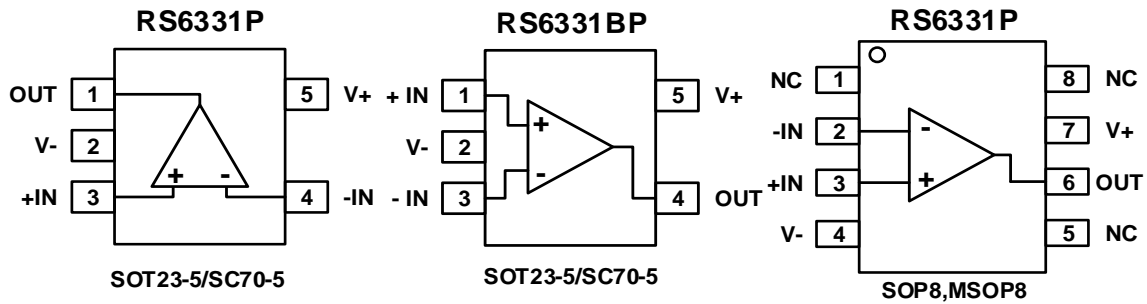

Pin Description

NAME	PIN			I/O	DESCRIPTION
	RS6331P	RS6331BP	RS6331P		
	SOT23-5/SC70-5	SOT23-5/SC70-5	SOP8/MSOP8		
-IN	4	3	2	I	Negative (inverting) input
+IN	3	1	3	I	Positive (noninverting) input
NC	-	-	1,5,8	-	No internal connection (can be left floating)
OUT	1	4	6	O	Output
V-	2	2	4	-	Negative (lowest) power supply
V+	5	5	7	-	Positive (highest) power supply

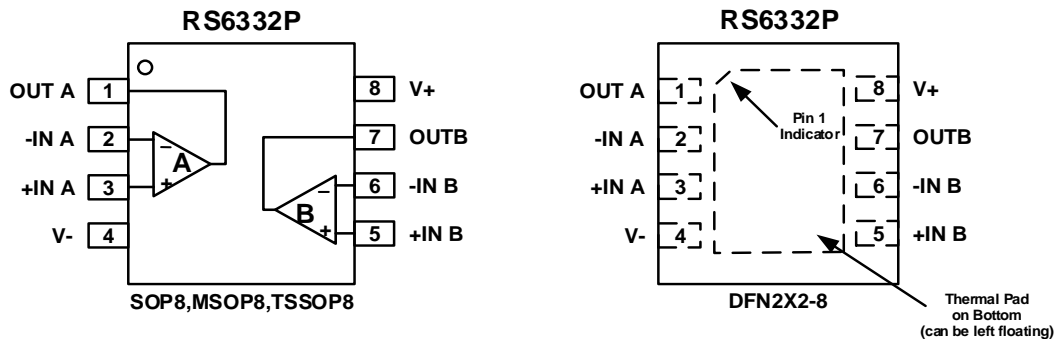

Pin Description

NAME	PIN	I/O	DESCRIPTION
	SOP8/MSOP8/TSSOP8/DFN2X2-8		
-INA	2	I	Inverting input, channel A
+INA	3	I	Noninverting input, channel A
-INB	6	I	Inverting input, channel B
+INB	5	I	Noninverting input, channel B
OUTA	1	O	Output, channel A
OUTB	7	O	Output, channel B
V-	4	-	Negative (lowest) power supply
V+	8	-	Positive (highest) power supply

Pin Configuration and Functions (Top View)

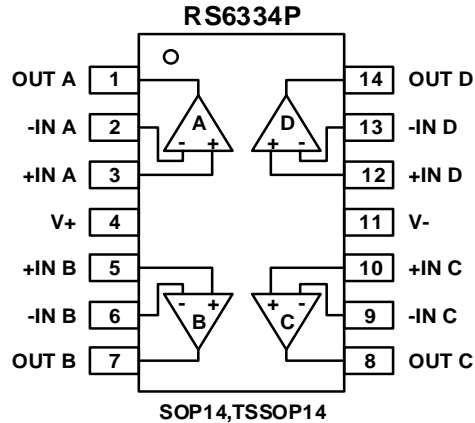

Pin Description

NAME	PIN	I/O	DESCRIPTION
	SOP14/TSSOP14		
-INA	2	I	Inverting input, channel A
+INA	3	I	Noninverting input, channel A
-INB	6	I	Inverting input, channel B
+INB	5	I	Noninverting input, channel B
-INC	9	I	Inverting input, channel C
+INC	10	I	Noninverting input, channel C
-IND	13	I	Inverting input, channel D
+IND	12	I	Noninverting input, channel D
OUTA	1	O	Output, channel A
OUTB	7	O	Output, channel B
OUTC	8	O	Output, channel C
OUTD	14	O	Output, channel D
V-	11	-	Negative (lowest) power supply
V+	4	-	Positive (highest) power supply

SPECIFICATIONS

Absolute Maximum Ratings

Over operating free-air temperature range (unless otherwise noted) ⁽¹⁾

		MIN	MAX	UNIT
Voltage	Supply, $V_s=(V+) - (V-)$		7	V
	Signal input pin ⁽²⁾	(V-)-0.5	(V+) +0.5	
	Signal output pin ⁽³⁾	(V-)-0.5	(V+) +0.5	
Current	Signal input pin ⁽²⁾	-10	10	mA
	Signal output pin ⁽³⁾	-140	140	mA
	Output short-circuit ⁽⁴⁾	Continuous		
Temperature	Operating range, T_A	-40	125	°C
	Junction, T_J	-40	150	
	Storage, T_{stg}	-65	150	

(1) Stresses above these ratings may cause permanent damage. Exposure to absolute maximum conditions for extended periods may degrade device reliability. These are stress ratings only, and functional operation of the device at these or any other conditions beyond those specified is not implied.

(2) Input terminals are diode-clamped to the power-supply rails. Input signals that can swing more than 0.5V beyond the supply rails should be current-limited to 10mA or less.

(3) Output terminals are diode-clamped to the power-supply rails. Output signals that can swing more than 0.5V beyond the supply rails should be current-limited to ± 140 mA or less.

(4) Short-circuit to ground, one amplifier per package.

ESD Ratings

			VALUE	UNIT
$V_{(ESD)}$	Electrostatic discharge	Human-body model (HBM)	± 3000	V
		Machine Model (MM)	± 200	

Recommended Operating Conditions

Over operating free-air temperature range (unless otherwise noted)

		MIN	NOM	MAX	UNIT
Supply voltage, $V_s= (V+) - (V-)$	Signal-supply	2.1		5.5	V
	Dual-supply	± 1.05		± 2.75	

Thermal Information: RS6331P

THERMAL METRIC		RS6331P				UNIT
		5PINS		8PINS		
		SOT23-5	SC70-5	SOP8	MSOP8	
$R_{\theta JA}$	Junction-to-ambient thermal resistance	273.8	214.7	116	165	°C/W
$R_{\theta JC(top)}$	Junction-to-case(top) thermal resistance	126.8	127.1	60	53	°C/W
$R_{\theta JB}$	Junction-to-board thermal resistance	85.9	60.0	56	87	°C/W
Ψ_{JT}	Junction-to-top characterization parameter	10.9	33.4	12.8	4.9	°C/W
Ψ_{JB}	Junction-to-board characterization parameter	84.9	59.8	98.3	85	°C/W
$R_{\theta JC(bot)}$	Junction-to-case(bottom) thermal resistance	N/A	N/A	N/A	N/A	°C/W

Thermal Information: RS6332P

THERMAL METRIC		RS6332P				UNIT
		8PINS				
		SOP8	MSOP8	TSSOP8	DFN2X2-8	
R _{EJA}	Junction-to-ambient thermal resistance	116	165	192	80.1	°C/W
R _{EJC(top)}	Junction-to-case(top) thermal resistance	60	53	64.3	100	°C/W
R _{EJB}	Junction-to-board thermal resistance	56	87	105.3	45	°C/W
Ψ _{JT}	Junction-to-top characterization parameter	12.8	4.9	7.6	6.8	°C/W
Ψ _{JB}	Junction-to-board characterization parameter	98.3	85	105.5	45.2	°C/W
R _{EJC(bot)}	Junction-to-case(bottom) thermal resistance	N/A	N/A	N/A	22.7	°C/W

Thermal Information: RS6334P

THERMAL METRIC		RS6334P		UNIT
		14PINS		
		SOP14	TSSOP14	
R _{EJA}	Junction-to-ambient thermal resistance	83.8	120.8	°C/W
R _{EJC(top)}	Junction-to-case(top) thermal resistance	70.7	34.3	°C/W
R _{EJB}	Junction-to-board thermal resistance	59.5	62.8	°C/W
Ψ _{JT}	Junction-to-top characterization parameter	11.6	1	°C/W
Ψ _{JB}	Junction-to-board characterization parameter	37.7	56.5	°C/W
R _{EJC(bot)}	Junction-to-case(bottom) thermal resistance	N/A	N/A	°C/W

PACKAGE/ORDERING INFORMATION

Orderable Device	Package Type	Pin	Channel	Op Temp(°C)	Device Marking	Package Qty
RS6331PXF	SOT23-5	5	1	-40°C ~125°C	6331P	Tape and Reel,3000
RS6331PXC5	SC70-5 ⁽¹⁾	5	1	-40°C ~125°C	6331P	Tape and Reel,3000
RS6331BPXF	SOT23-5	5	1	-40°C ~125°C	6331BP	Tape and Reel,3000
RS6331BPXC5	SC70-5 ⁽¹⁾	5	1	-40°C ~125°C	6331BP	Tape and Reel,3000
RS6332P XK	SOP8	8	2	-40°C ~125°C	RS6332P	Tape and Reel,4000
RS6332P XM	MSOP8	8	2	-40°C ~125°C	RS6332P	Tape and Reel,4000
RS6332P XQ	TSSOP8	8	2	-40°C ~125°C	RS6332P	Tape and Reel,4000
RS6334P XP	SOP14	14	4	-40°C ~125°C	RS6334P	Tape and Reel,4000
RS6334P XQ	TSSOP14	14	4	-40°C ~125°C	RS6334P	Tape and Reel,4000

NOTE:

(1) Equivalent to SOT353.

ELECTRICAL CHARACTERISTICS

(At $T_A = +25^\circ\text{C}$, $V_S = 5\text{V}$, $R_L = 10\text{k}\Omega$ connected to $V_S/2$, and $V_{OUT} = V_S/2$, unless otherwise noted.)

PARAMETER		CONDITIONS	T_J	RS6331P, RS6332P, RS6334P			
				MIN	TYP	MAX	UNIT
POWER SUPPLY							
V_S	Operating Voltage Range		25°C	2.1		5.5	V
I_Q	Quiescent Current/Amplifier		25°C		85	145	μA
PSRR	Power-Supply Rejection Ratio	$V_S = 2.1\text{V to } 5.5\text{V}$, $V_{CM} = (V_-) + 0.5\text{V}$	25°C	75	92		dB
			$-40^\circ\text{C to } 125^\circ\text{C}$	65			
t_{ON}	Turn-on time	$V_S = 5\text{V}$			20		μs
INPUT							
V_{OS}	Input Offset Voltage	RS6331P	25°C	-0.5	± 0.2	0.5	mV
		RS6332P	25°C	-0.5	± 0.2	0.5	
		RS6334P	25°C	-0.8	± 0.3	0.8	
$V_{OS}T_C$	Input Offset Voltage Average Drift		$-40^\circ\text{C to } 125^\circ\text{C}$		± 2		$\mu\text{V}/^\circ\text{C}$
I_B	Input Bias Current		25°C		± 10	± 50	pA
I_{OS}	Input Offset Current		25°C		± 10	± 50	pA
V_{CM}	Common-Mode Voltage Range	$V_S = 5.5\text{V}$	25°C	-0.1		5.6	V
CMRR	Common-Mode Rejection Ratio	$V_S = 5.5\text{V}$, $V_{CM} = -0.1\text{V to } 4\text{V}$	25°C	75	95		dB
			$-40^\circ\text{C to } 125^\circ\text{C}$	68			
		$V_S = 5.5\text{V}$, $V_{CM} = -0.1\text{V to } 5.6\text{V}$	25°C	63	85		
			$-40^\circ\text{C to } 125^\circ\text{C}$	57			
OUTPUT							
A_{OL}	Open-Loop Voltage Gain	$R_L = 2\text{k}\Omega$, $V_O = 0.15\text{V to } 4.85\text{V}$	25°C	95	110		dB
			$-40^\circ\text{C to } 125^\circ\text{C}$	85			
		$R_L = 10\text{k}\Omega$, $V_O = 0.05\text{V to } 4.95\text{V}$	25°C	100	120		
			$-40^\circ\text{C to } 125^\circ\text{C}$	92			
	Output Swing From Rail	$R_L = 2\text{k}\Omega$	25°C		25		mV
		$R_L = 10\text{k}\Omega$			8		
I_{OUT}	Output Current Source		25°C		120		mA
FREQUENCY RESPONSE							
SR	Slew Rate		25°C		0.5		V/ μs
GBP	Gain-Bandwidth Product		25°C		1.1		MHz
PM	Phase Margin		25°C		64		$^\circ$
t_s	Setting Time, 0.1%				1.3		μs
	Overload Recovery Time	$V_{IN} \text{ Gain} \geq V_S$			4.7		μs
NOISE							
e_n	Input Voltage Noise Density	$f = 1\text{KHz}$	25°C		22		$\text{nV}/\sqrt{\text{Hz}}$
		$f = 10\text{KHz}$	25°C		20		$\text{nV}/\sqrt{\text{Hz}}$

TYPICAL CHARACTERISTICS

At $T_A = +25^\circ\text{C}$, $V_S = 5\text{V}$, $R_L = 10\text{k}\Omega$ connected to $V_S/2$, $V_{OUT} = V_S/2$, unless otherwise noted.

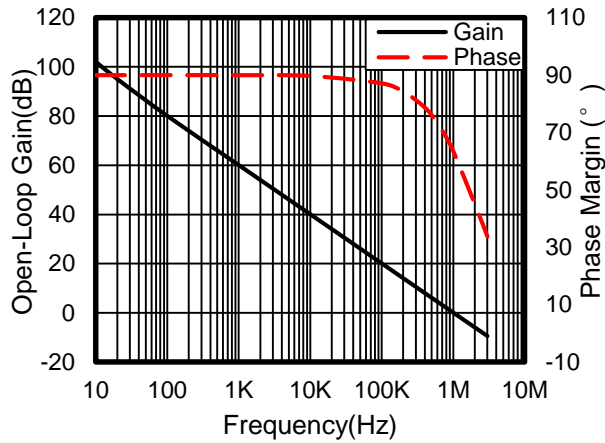

Figure 1. Open-Loop Gain and Phase vs Frequency

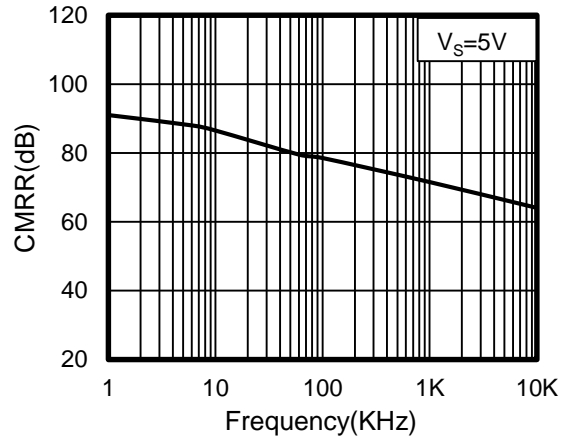

Figure 2. Common-Mode Rejection Ratio vs Frequency

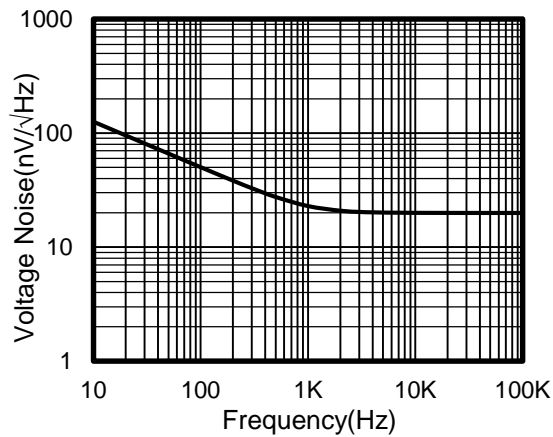

Figure 3. Input Voltage Noise Spectral Density vs Frequency

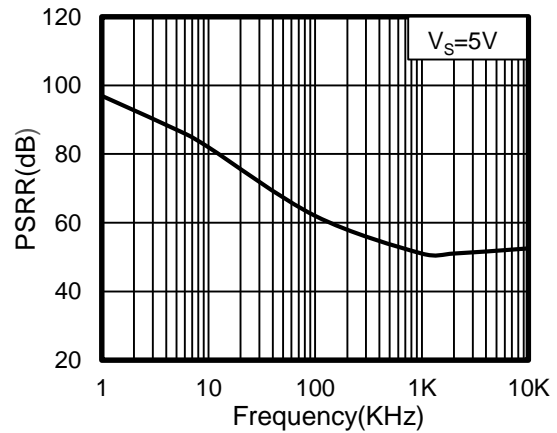

Figure 4. Power-Supply Rejection Ratio vs Frequency

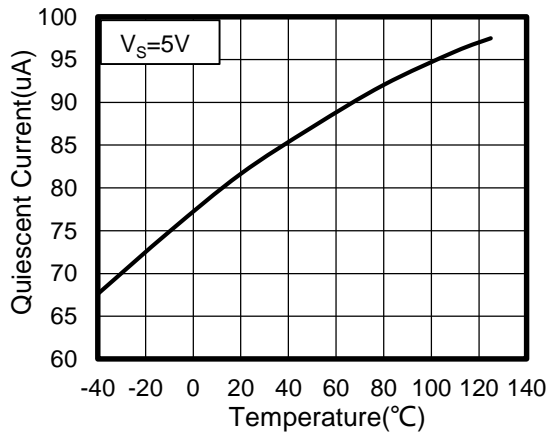

Figure 5. Quiescent Current vs Temperature

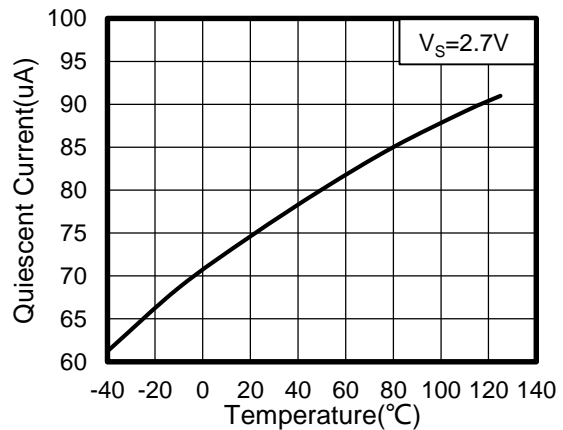

Figure 6. Quiescent Current vs Temperature

TYPICAL CHARACTERISTICS

At $T_A = +25^\circ\text{C}$, $V_S = 5\text{V}$, $R_L = 10\text{k}\Omega$ connected to $V_S/2$, $V_{OUT} = V_S/2$, unless otherwise noted.

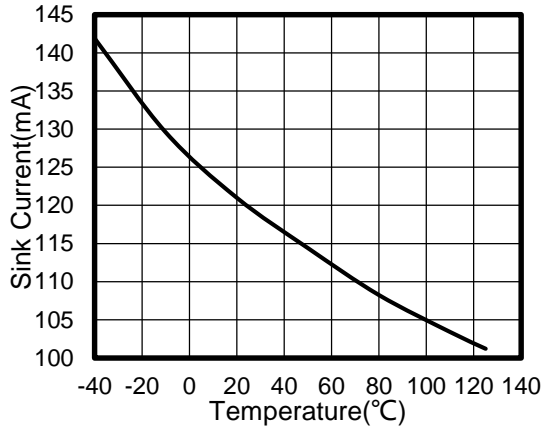

Figure 7. Sink Current vs Temperature

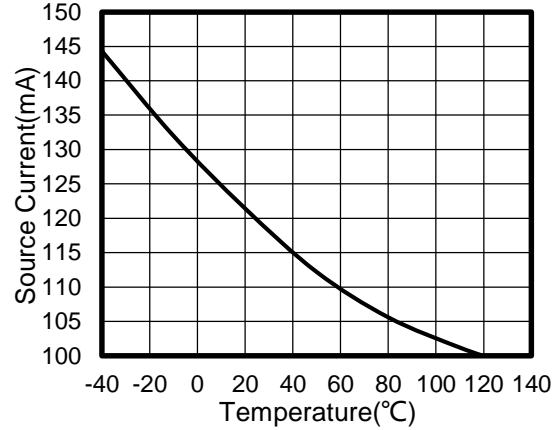

Figure 8. Source Current vs Temperature

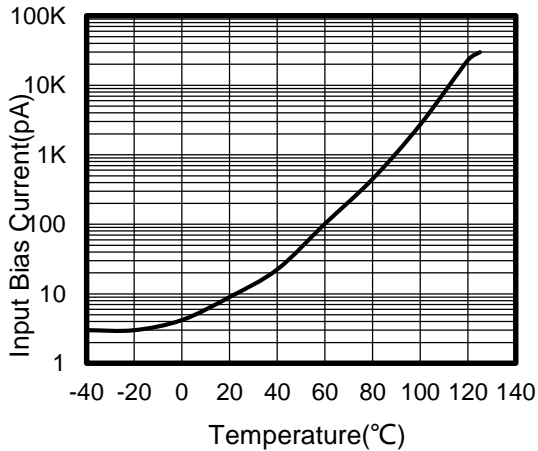

Figure 9. Input Bias Current vs Temperature

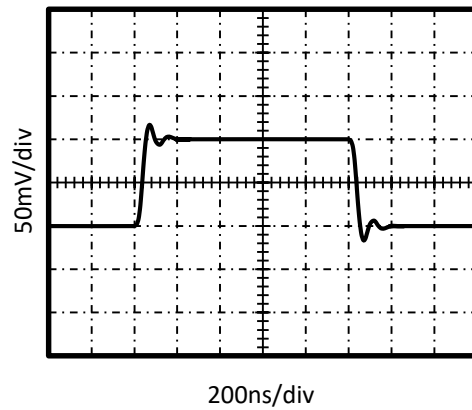

Figure 10. SMALL-SIGNAL STEP RESPONSE

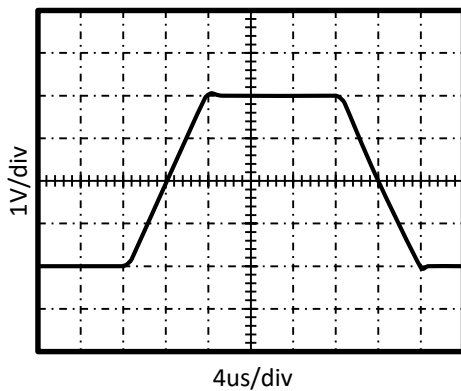

Figure 11. LARGE-SIGNAL STEP RESPONSE

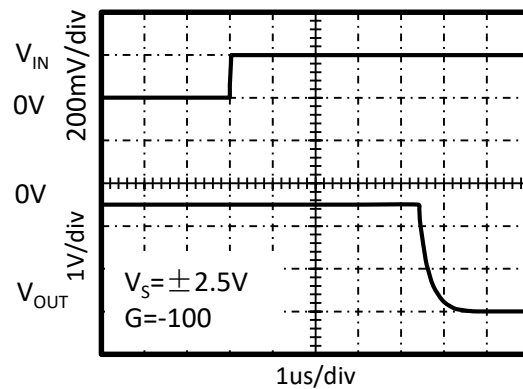

Figure 12. POSITIVE OVERVOLTAGE RECOVERY

TYPICAL CHARACTERISTICS

At $T_A = +25^\circ\text{C}$, $V_S = 5\text{V}$, $R_L = 10\text{k}\Omega$ connected to $V_S/2$, $V_{OUT} = V_S/2$, unless otherwise noted.

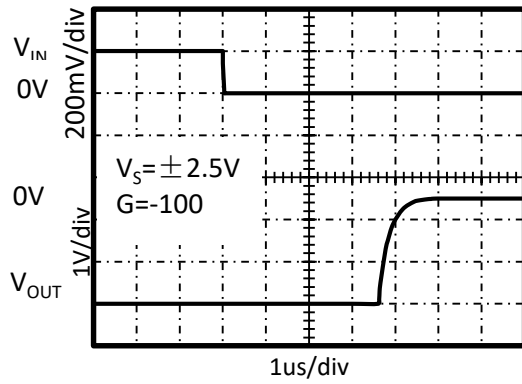

Figure 13. NEGATIVE OVERVOLTAGE RECOVERY

Detailed Description

Overview

The RS633XP devices are unity-gain stable, dual and qual-channel op amps with low noise and distortion. The device consists of a low noise input stage with a folded cascade and a rail-to-rail output stage. This topology exhibits superior noise and distortion performance across a wide range of supply voltages that are not delivered by legacy commodity audio operational amplifiers.

Phase Reversal Protection

The RS633XP family has internal phase-reversal protection. Many op amps exhibit phase reversal when the input is driven beyond the linear common-mode range. This condition is most often encountered in noninverting circuits when the input is driven beyond the specified common-mode voltage range, causing the output to reverse into the opposite rail. The input of the RS633XP prevents phase reversal with excessive common-mode voltage. Instead, the appropriate rail limits the output voltage. This performance is shown in figure 14

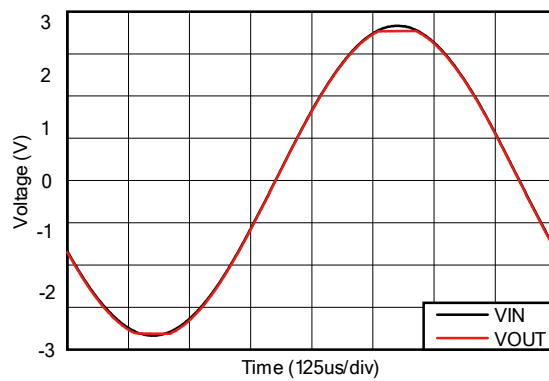

Figure 14. Output Waveform Devoid of Phase Reversal During an Input Overdrive Condition

EMI Rejection Ratio (EMIRR)

The electromagnetic interference (EMI) rejection ratio, or EMIRR, describes the EMI immunity of operational amplifiers. An adverse effect that is common to many operational amplifiers is a change in the offset voltage as a result of RF signal rectification. An operational amplifier that is more efficient at rejecting this change in offset as a result of EMI has a higher EMIRR and is quantified by a decibel value. Measuring EMIRR can be performed in many ways, but this document provides the EMIRR IN+, which specifically describes the EMIRR performance when the RF signal is applied to the noninverting input pin of the operational amplifier. In general, only the noninverting input is tested for EMIRR for the following three reasons:

- Operational amplifier input pins are known to be the most sensitive to EMI, and typically rectify RF signals better than the supply or output pins.
- The noninverting and inverting operational amplifier inputs have symmetrical physical layouts and exhibit nearly matching EMIRR performance.
- EMIRR is easier to measure on noninverting pins than on other pins because the noninverting input pin can be isolated on a printed-circuit-board (PCB). This isolation allows the RF signal to be applied directly to the noninverting input pin with no complex interactions from other components or connecting PCB traces.

Detailed Description (continued)

The EMIRR IN+ of the RS633XP is plotted versus frequency in Figure 15. If available, any dual and quad operational amplifier device versions have approximately identical EMIRR IN+ performance. The RS633XP unity-gain bandwidth is 1.1MHz. EMIRR performance below this frequency denotes interfering signals that fall within the operational amplifier bandwidth.

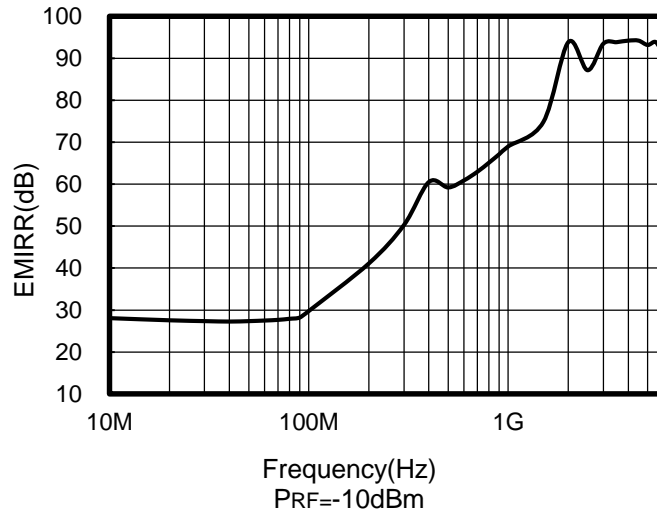

Figure 15. RS633XP EMIRR vs Frequency

EMIRR IN+ Test Configuration

Figure 16 shows the circuit configuration for testing the EMIRR IN+. An RF source is connected to the operational amplifier noninverting input pin using a transmission line. The operational amplifier is configured in a unity-gain buffer topology with the output connected to a low-pass filter (LPF) and a digital multimeter (DMM). A large impedance mismatch at the operational amplifier input causes a voltage reflection; however, this effect is characterized and accounted for when determining the EMIRR IN+. The resulting dc offset voltage is sampled and measured by the multimeter. The LPF isolates the multimeter from residual RF signals that can interfere with multimeter accuracy.

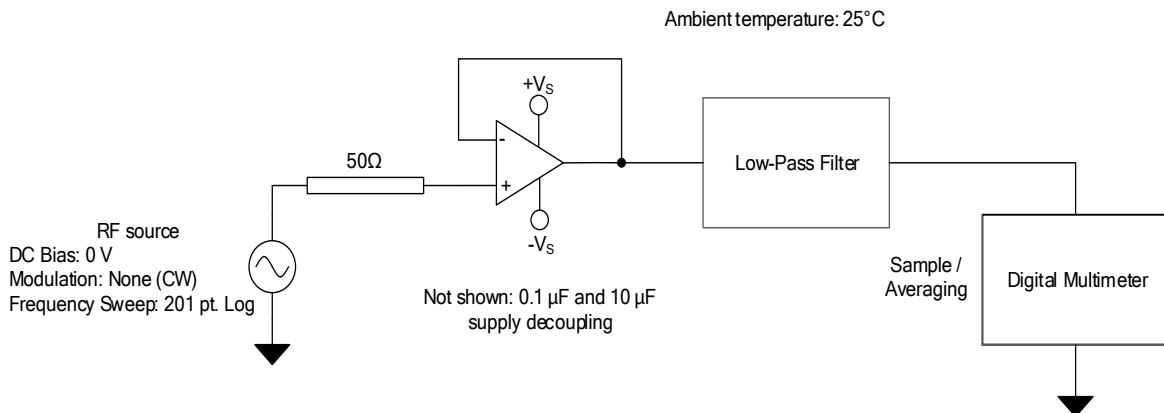

Figure 16. EMIRR IN+ Test Configuration Schematic

APPLICATION NOTES

The RS6331P, RS6332P, RS6334P are high precision, rail-to-rail operational amplifiers that can be run from a single-supply voltage 2.1V to 5.5V ($\pm 1.05V$ to $\pm 2.75V$). Supply voltages higher than 7V (absolute maximum) can permanently damage the amplifier. Rail-to-rail input and output swing significantly increases dynamic range, especially in low-supply applications. Good layout practice mandates use of a 0.1 μF capacitor place closely across the supply pins.

Typical Applications

25-kHz Low-pass Filter

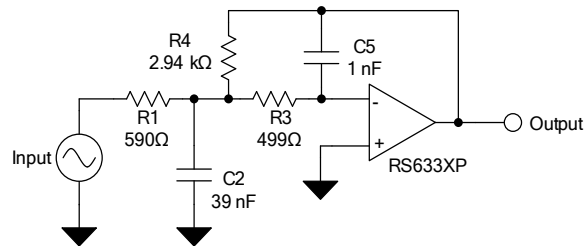

Figure 17. 25-kHz Low-Pass Filter

Design Requirements

Low-pass filters are commonly employed in signal processing applications to reduce noise and prevent aliasing. The RS6333XP devices are ideally suited to construct high-speed, high-precision active filters. Figure 17 shows a second-order, low-pass filter commonly encountered in signal processing applications.

Use the following parameters for this design example:

- Gain = 5 V/V (inverting gain)
- Low-pass cutoff frequency = 25 kHz
- Second-order Chebyshev filter response with 3-dB gain peaking in the passband

Detailed Design Procedure

The infinite-gain multiple-feedback circuit for a low-pass network function is shown in Figure 17. Use Equation 1 to calculate the voltage transfer function.

$$\frac{\text{Output}}{\text{Input}}(s) = \frac{-1/R_1 R_3 C_2 C_5}{s^2 + (s/C_2) (1/R_1 + 1/R_3 + 1/R_4) + 1/R_3 R_4 C_2 C_5} \quad (1)$$

This circuit produces a signal inversion. For this circuit, the gain at dc and the low-pass cutoff frequency are calculated by Equation 2:

$$\text{Gain} = \frac{R_4}{R_1}$$

$$f_c = \frac{1}{2\pi} \sqrt{(1/R_3 R_4 C_2 C_5)} \quad (2)$$

Application Curve

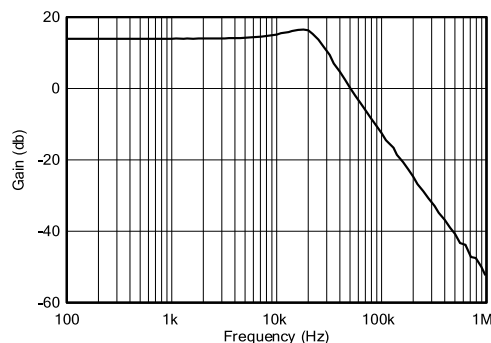

Figure 18. Low pass filter transfer function

LAYOUT GUIDELINS

Attention to good layout practices is always recommended. Keep traces short. When possible, use a PCB ground plane with surface-mount components placed as close to the device pins as possible. Place a 0.1uF capacitor closely across the supply pins.

These guidelines should be applied throughout the analog circuit to improve performance and provide benefits such as reducing the EMI susceptibility.

Layout Example

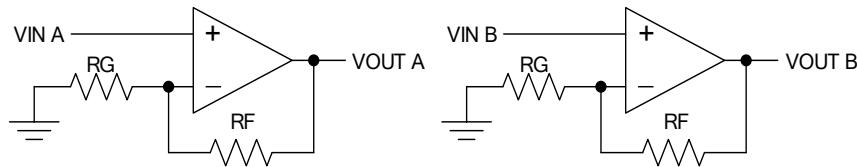

Figure 19. Schematic Representation

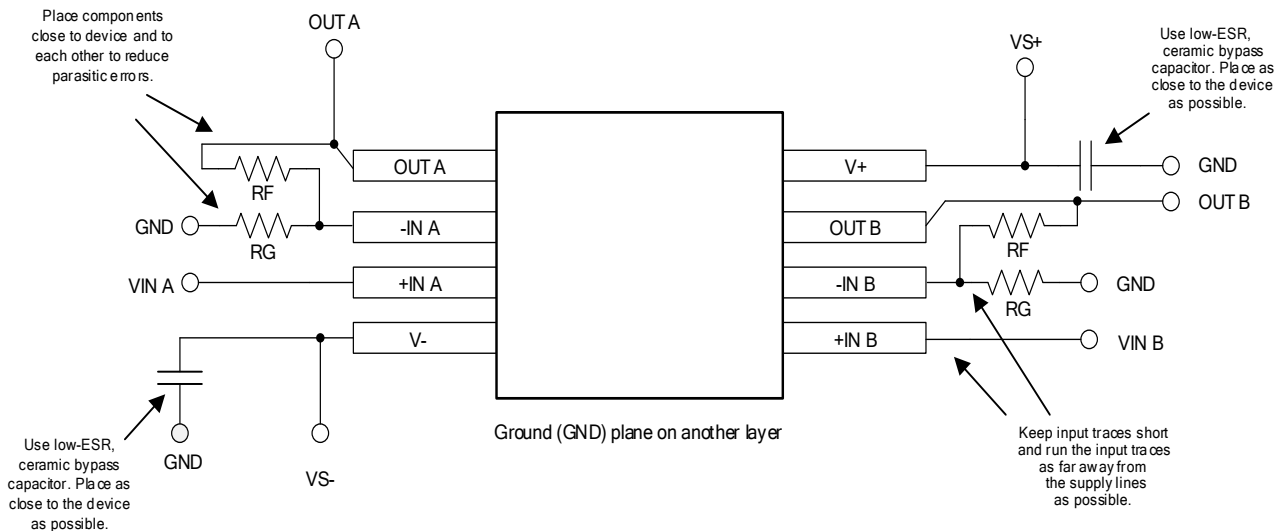
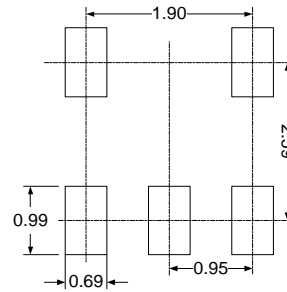
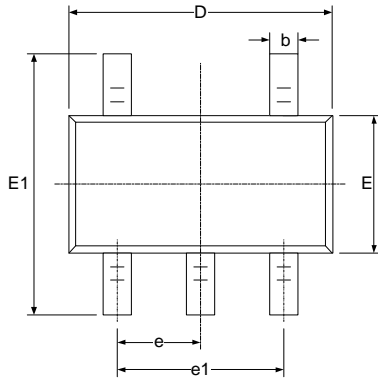
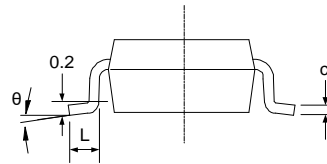
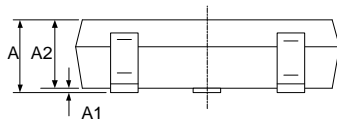
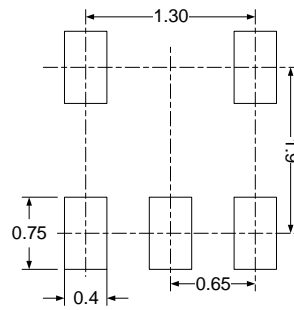
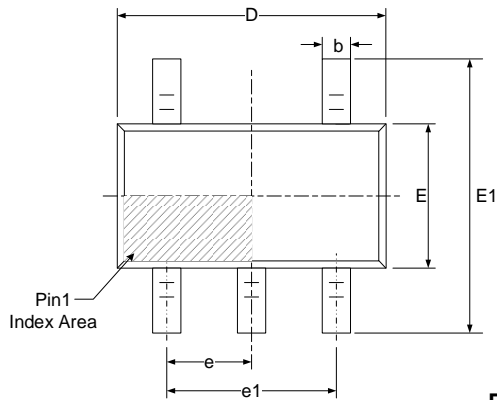
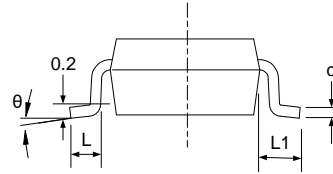
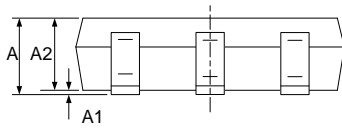

Figure 20. Layout Example

PACKAGE OUTLINE DIMENSIONS
SOT23-5

RECOMMENDED LAND PATTERN (Unit: mm)

Symbol	Dimensions In Millimeters		Dimensions In Inches	
	Min	Max	Min	Max
A	1.050	1.250	0.041	0.049
A1	0.000	0.100	0.000	0.004
A2	1.050	1.150	0.041	0.045
b	0.300	0.500	0.012	0.020
c	0.100	0.200	0.004	0.008
D	2.820	3.020	0.111	0.119
E	1.500	1.700	0.059	0.067
E1	2.650	2.950	0.104	0.116
e	0.950(BSC)		0.037(BSC)	
e1	1.800	2.000	0.071	0.079
L	0.300	0.600	0.012	0.024
θ	0°	8°	0°	8°

SC70-5

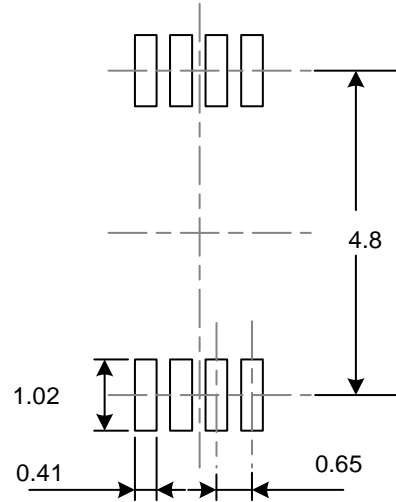
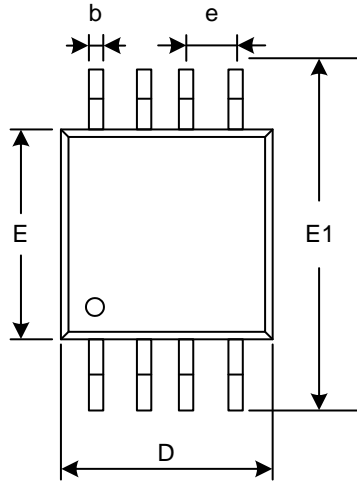
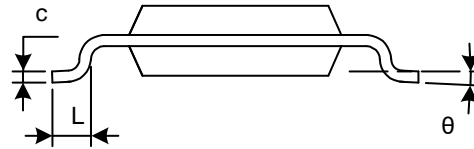
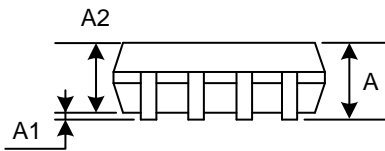
RECOMMENDED LAND PATTERN (Unit: mm)

Symbol	Dimensions In Millimeters		Dimensions In Inches	
	Min	Max	Min	Max
A	0.900	1.100	0.035	0.043
A1	0.000	0.100	0.000	0.004
A2	0.900	1.000	0.035	0.039
b	0.150	0.350	0.006	0.014
c	0.080	0.150	0.003	0.006
D	2.000	2.200	0.079	0.087
E	1.150	1.350	0.045	0.053
E1	2.150	2.450	0.085	0.096
e	0.650(BSC)		0.026(BSC)	
e1	1.300(BSC)		0.051(BSC)	
L	0.260	0.460	0.010	0.018
L1	0.525		0.021	
θ	0°	8°	0°	8°

MSOP8

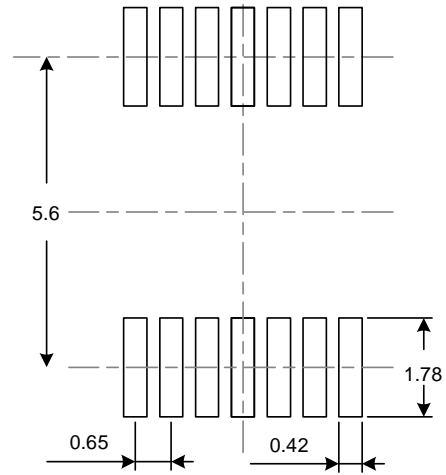
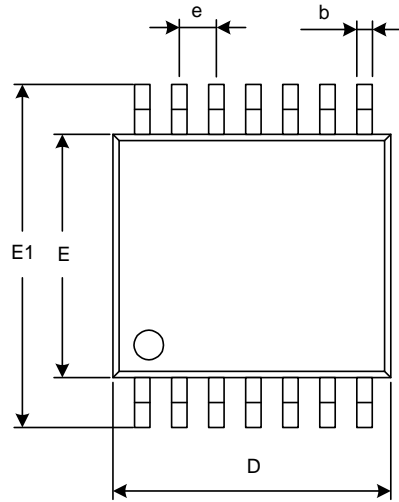
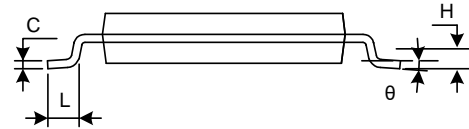
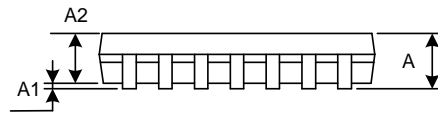
RECOMMENDED LAND PATTERN (Unit: mm)

Symbol	Dimensions In Millimeters		Dimensions In Inches	
	Min	Max	Min	Max
A	0.820	1.100	0.032	0.043
A1	0.020	0.150	0.001	0.006
A2	0.750	0.950	0.030	0.037
b	0.250	0.380	0.010	0.015
c	0.090	0.230	0.004	0.009
D	2.900	3.100	0.114	0.122
e	0.650(BSC)		0.026(BSC)	
E	2.900	3.100	0.114	0.122
E1	4.750	5.050	0.187	0.199
L	0.400	0.800	0.016	0.031
θ	0°	6°	0°	6°

TSSOP14

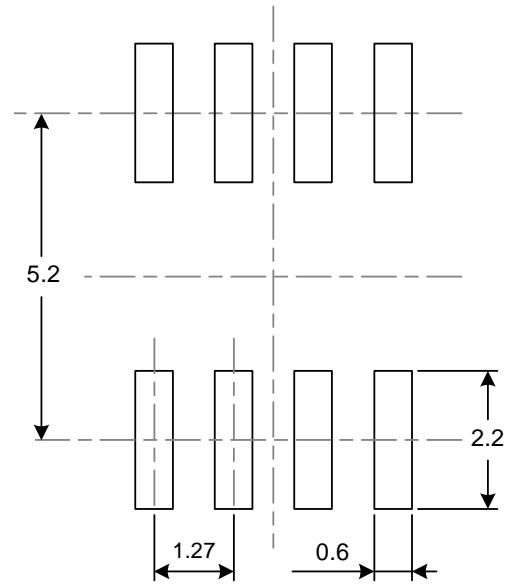
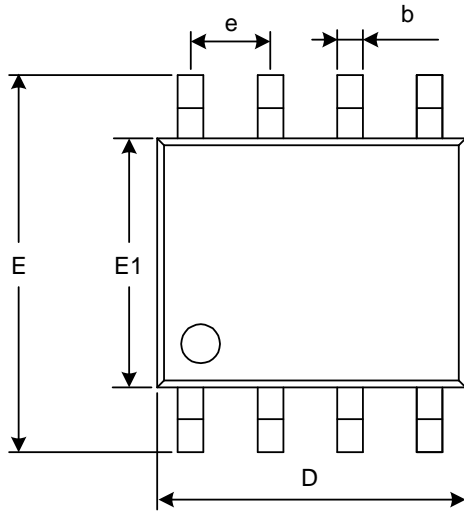
RECOMMENDED LAND PATTERN (Unit: mm)

Symbol	Dimensions In Millimeters		Dimensions In Inches	
	Min	Max	Min	Max
A		1.200		0.047
A1	0.050	0.150	0.002	0.006
A2	0.800	1.050	0.031	0.041
b	0.190	0.300	0.007	0.012
c	0.090	0.200	0.004	0.008
D	4.860	5.100	0.191	0.201
E	4.300	4.500	0.169	0.177
E1	6.250	6.550	0.246	0.258
e	0.650(BSC)		0.026(BSC)	
L	0.500	0.700	0.020	0.028
H	0.25(TYP)		0.01(TYP)	
θ	1°	7°	1°	7°

SOP8

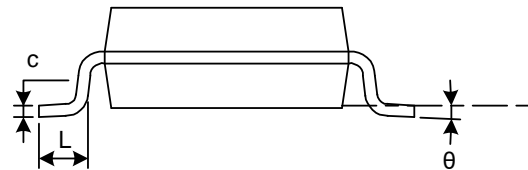
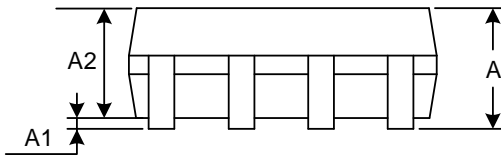
RECOMMENDED LAND PATTERN
(Unit: mm)

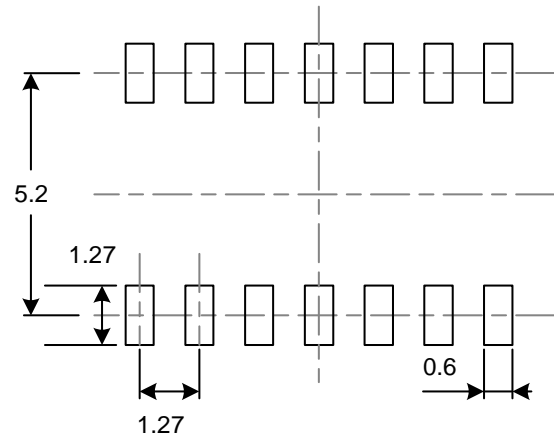
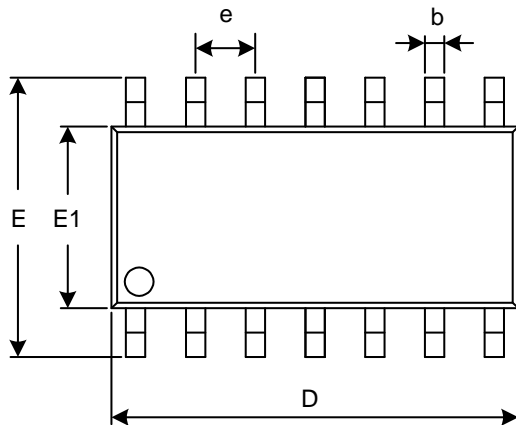
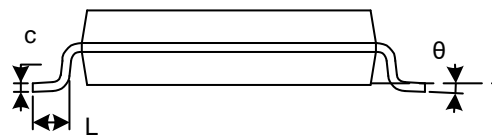
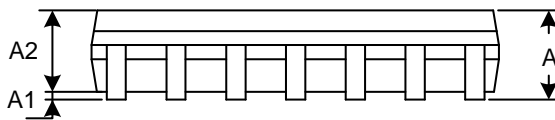

Symbol	Dimensions In Millimeters		Dimensions In Inches	
	Min	Max	Min	Max
A	1.350	1.750	0.053	0.069
A1	0.100	0.250	0.004	0.010
A2	1.350	1.550	0.053	0.061
b	0.330	0.510	0.013	0.020
c	0.170	0.250	0.007	0.010
D	4.800	5.000	0.189	0.197
e	1.270(BSC)		0.050(BSC)	
E	5.800	6.200	0.228	0.244
E1	3.800	4.000	0.150	0.157
L	0.400	1.270	0.016	0.050
θ	0°	8°	0°	8°

SOP14

RECOMMENDED LAND PATTERN (Unit: mm)

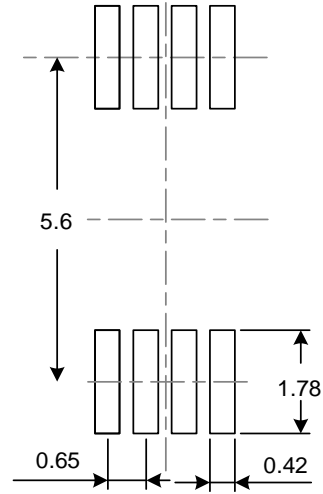
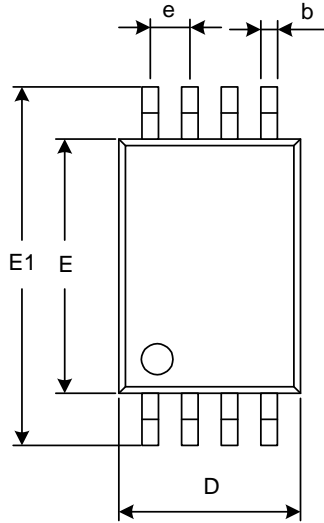
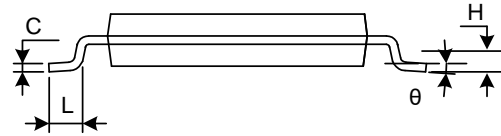
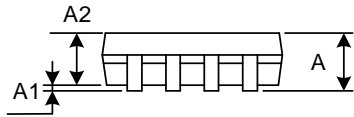
Symbol	Dimensions In Millimeters		Dimensions In Inches	
	Min	Max	Min	Max
A	1.350	1.750	0.053	0.069
A1	0.100	0.250	0.004	0.010
A2	1.350	1.550	0.053	0.061
b	0.310	0.510	0.012	0.020
c	0.100	0.250	0.004	0.010
D	8.450	8.850	0.333	0.348
e	1.270(BSC)		0.050(BSC)	
E	5.800	6.200	0.228	0.244
E1	3.800	4.000	0.150	0.157
L	0.400	1.270	0.016	0.050
θ	0°	8°	0°	8°

TSSOP8

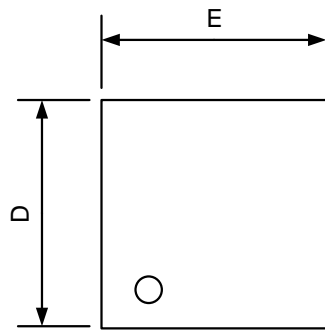
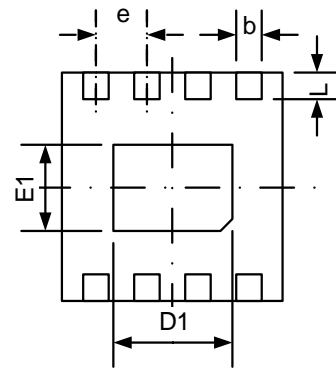
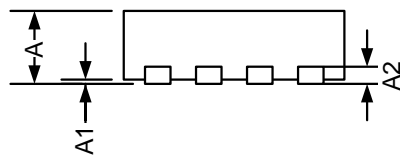
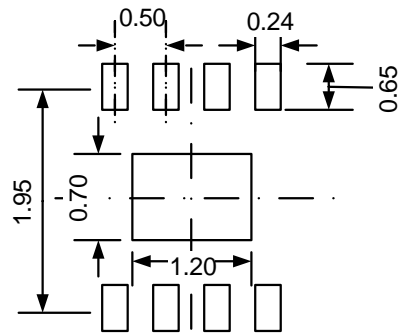
RECOMMENDED LAND PATTERN (Unit: mm)

Symbol	Dimensions In Millimeters		Dimensions In Inches	
	Min	Max	Min	Max
A		1.200		0.047
A1	0.050	0.150	0.002	0.006
A2	0.800	1.050	0.031	0.041
b	0.190	0.300	0.007	0.012
c	0.090	0.200	0.004	0.008
D	2.900	3.100	0.114	0.122
E	4.300	4.500	0.169	0.177
E1	6.250	6.550	0.246	0.258
e	0.650(BSC)		0.026(BSC)	
L	0.500	0.700	0.020	0.028
H	0.25(TYP)		0.01(TYP)	
θ	1°	7°	1°	7°

DFN2X2-8

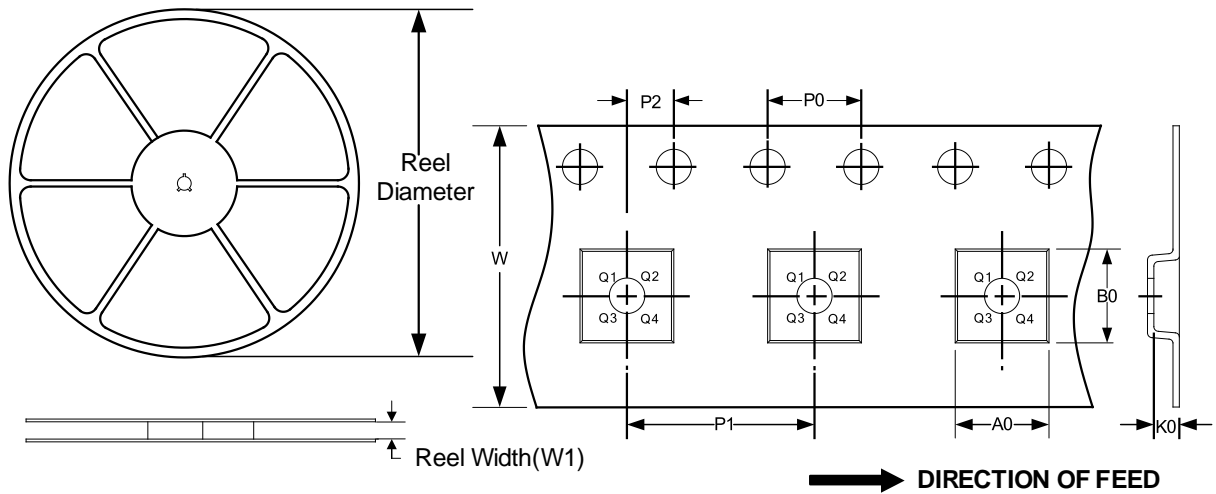
TOP VIEW

BOTTOM VIEW

SIDE VIEW

RECOMMENDED LAND PATTERN
(Unit: mm)

Symbol	Dimensions In Millimeters		Dimensions In Inches	
	Min	Max	Min	Max
A	0.700	0.800	0.028	0.031
A1	0.000	0.050	0.000	0.002
A2	0.203(TYP)		0.008(TYP)	
b	0.180	0.300	0.007	0.012
D	1.900	2.100	0.075	0.083
D1	1.100	1.300	0.043	0.051
E	1.900	2.100	0.075	0.083
E1	0.600	0.800	0.024	0.031
e	0.500(TYP)		0.020(TYP)	
L	0.250	0.450	0.010	0.018

TAPE AND REEL INFORMATION
REEL DIMENSIONS
TAPE DIMENSION

NOTE: The picture is only for reference. Please make the object as the standard.

KEY PARAMETER LIST OF TAPE AND REEL

Package Type	Reel Diameter	Reel Width (mm)	A0 (mm)	B0 (mm)	K0 (mm)	P0 (mm)	P1 (mm)	P2 (mm)	W (mm)	Pin1 Quadrant
SOT23-5	7"	9.5	3.20	3.20	1.40	4.0	4.0	2.0	8.0	Q3
SC70-5	7"	9.5	2.25	2.55	1.20	4.0	4.0	2.0	8.0	Q3
MSOP8	13"	12.4	5.20	3.30	1.50	4.0	8.0	2.0	12.0	Q1
SOP8	13"	12.4	6.40	5.40	2.10	4.0	8.0	2.0	12.0	Q1
DFN2X2-8	7"	9.5	2.30	2.30	1.10	4.0	4.0	2.0	8.0	Q2
TSSOP14	13"	12.4	6.95	5.60	1.20	4.0	8.0	2.0	14.0	Q1
SOP14	13"	16.4	6.60	9.30	2.10	4.0	8.0	2.0	16.0	Q1