

# General-Purpose High-Voltage Open-Drain Output Quad Comparators

## 1 FEATURES

- **Supply Range: +3.3V to +32V**
- **Low Supply Current**  
**45µA (TYP) per channel at  $V_s = 5V$**
- **Common-Mode Input Voltage Range Includes Ground**
- **Low Output Saturation Voltage**
- **Open-Drain Output for Maximum Flexibility**
- **SPECIFIED UP TO +125°C**
- **PACKAGES: SOP14, TSSOP14**

## 2 APPLICATIONS

- **Hysteresis Comparators**
- **Factory Automation & Control**
- **Industrial Equipment**
- **Test and Measurement**
- **Cordless Power Tool**
- **Vacuum Robot**
- **Wireless Infrastructure**

## 3 DESCRIPTIONS

The LM2901 is the quad comparators version, and the outputs can be connected to other open-collector outputs to achieve wired-AND relationships. It can operate from 3.3V to 32V, and have low power consuming 45µA (TYP) per channel.

The LM2901 consist of four independent voltage comparators that are designed to operate from a single power supply over a wide range of voltages. Quiescent current is independent of the supply voltage. The device is the most cost-effective solutions for applications where low offset voltage, high supply voltage capability, low supply current, and space saving are the primary specifications in circuit design for portable consumer products.

The LM2901 is available in Green SOP14, TSSOP14 packages. It operates over an ambient temperature range of -40°C to +125°C.

**Device Information (1)**

PART NUMBER	PACKAGE	BODY SIZE (NOM)
LM2901	SOP14	8.65mm×3.90mm
	TSSOP14	5.00mm×4.40mm

(1) For all available packages, see the orderable addendum at the end of the data sheet.

## Table of Contents

<b>1 FEATURES</b> .....	1
<b>2 APPLICATIONS</b> .....	1
<b>3 DESCRIPTIONS</b> .....	1
<b>4 Revision History</b> .....	3
<b>5 PACKAGE/ORDERING INFORMATION</b> <sup>(1)</sup> .....	4
<b>6 Pin Configuration and Functions (Top View)</b> .....	5
<b>7 SPECIFICATIONS</b> .....	6
7.1 Absolute Maximum Ratings .....	6
7.2 ESD Ratings .....	6
7.3 Recommended Operating Conditions .....	6
7.4 ELECTRICAL CHARACTERISTICS .....	7
7.5 TYPICAL CHARACTERISTICS .....	8
<b>8 Detailed Description</b> .....	9
8.1 Overview .....	9
<b>9 Application and Implementation</b> .....	10
9.1 Application Information .....	10
9.2 Typical Application .....	10
9.3 Detailed Design Procedure .....	10
9.4 Input Voltage Range .....	10
<b>10 Layout</b> .....	11
10.1 Layout Guidelines .....	11
10.2 Layout Example .....	11
<b>11 PACKAGE OUTLINE DIMENSIONS</b> .....	12
<b>12 TAPE AND REEL INFORMATION</b> .....	14

## 4 Revision History

Note: Page numbers for previous revisions may differ from page numbers in the current version.

VERSION	Change Date	Change Item
A.0	2020/11/05	Initial version completed
A.1	2021/07/05	Correction of SOP14 orderable device in Page 5@ A.0 Version
A.2	2022/03/16	<ol style="list-style-type: none"> <li>1. Increase the minimum junction temperature</li> <li>2. Add the schematic diagram of comparator in the pin configuration and functions diagram</li> <li>3. Change ESD Ratings</li> </ol>
A.3	2022/07/15	<ol style="list-style-type: none"> <li>1. Change Supply Range: +3.3V to +32V</li> <li>2. Added CDM ESD Ratings</li> </ol>
A.4	2022/08/08	Change KEY PARAMETER LIST OF TAPE AND REEL in Page 15@ A.3 Version
A.4.1	2024/02/23	Modify packaging naming
A.5	2024/03/27	<ol style="list-style-type: none"> <li>1. Added MSL on Page 4@RevA.4.1</li> <li>2. Update Package thermal impedance</li> <li>3. Update PACKAGE note</li> </ol>

**5 PACKAGE/ORDERING INFORMATION <sup>(1)</sup>**

Orderable Device	Package Type	Pin	Channel	Op Temp(°C)	Device Marking <sup>(2)</sup>	MSL <sup>(3)</sup>	Package Qty
LM2901XP	SOP14	14	4	-40°C ~+125°C	LM2901	MSL3	Tape and Reel, 4000
LM2901XQ	TSSOP14	14	4	-40°C ~+125°C	LM2901	MSL3	Tape and Reel, 4000

## NOTE:

- (1) This information is the most current data available for the designated devices. This data is subject to change without notice and revision of this document. For browser-based versions of this data sheet, refer to the right-hand navigation.
- (2) There may be additional marking, which relates to the lot trace code information (data code and vendor code), the logo or the environmental category on the device.
- (3) MSL, The Moisture Sensitivity Level rating according to the JEDEC industry standard classifications.

## 6 Pin Configuration and Functions (Top View)

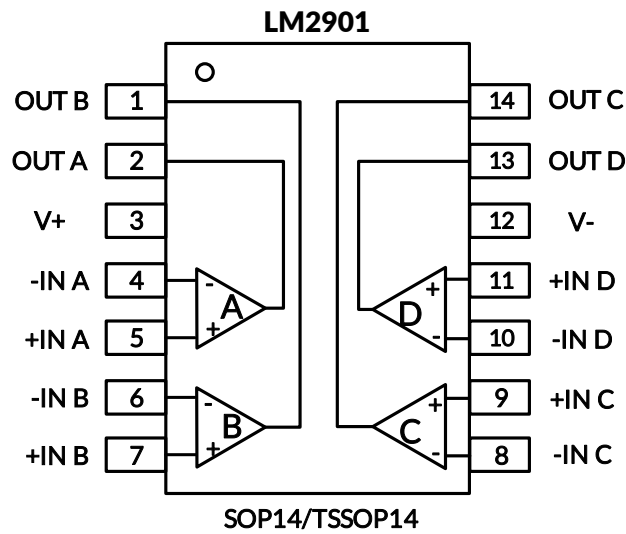

### Pin Description

NAME	PIN	I/O <sup>(1)</sup>	DESCRIPTION
	SOP14/TSSOP14		
OUTB	1	O	Output, channel B
OUTA	2	O	Output, channel A
V+	3	P	Positive (highest) power supply
-INA	4	I	Inverting input, channel A
+INA	5	I	Noninverting input, channel A
-INB	6	I	Inverting input, channel B
+INB	7	I	Noninverting input, channel B
-INC	8	I	Inverting input, channel C
+INC	9	I	Noninverting input, channel C
-IND	10	I	Inverting input, channel D
+IND	11	I	Noninverting input, channel D
V-	12	P	Negative (lowest) power supply
OUTD	13	O	Output, channel D
OUTC	14	O	Output, channel C

(1) I=Input, O=Output, P=Power.

## 7 SPECIFICATIONS

### 7.1 Absolute Maximum Ratings

Over operating free-air temperature range (unless otherwise noted) <sup>(1)</sup>

		MIN	MAX	UNIT
Voltage	Supply, $V_S=(V+) - (V-)$		36	V
	Input pin (IN+, IN-) <sup>(2)</sup>	(V-)-0.3	(V+) +0.3	
	Signal output pin <sup>(3)</sup>	(V-)-0.3	(V+) +0.3	
Current	Signal input pin (IN+, IN-) <sup>(2)</sup>	-10	10	mA
	Signal output pin <sup>(3)</sup>	-55	55	mA
	Output short-circuits <sup>(4)</sup>	Continuous		
$\theta_{JA}$	Package thermal impedance <sup>(5)</sup>	SOP14	105	°C/W
		TSSOP14	90	
Temperature	Operating range, $T_A$	-40	125	°C
	Junction, $T_J$ <sup>(6)</sup>	-40	150	
	Storage, $T_{stg}$	-65	150	

(1) Stresses above these ratings may cause permanent damage. Exposure to absolute maximum conditions for extended periods may degrade device reliability. These are stress ratings only, and functional operation of the device at these or any other conditions beyond those specified is not implied.

(2) Input terminals are diode-clamped to the power-supply rails. Input signals that can swing more than 0.3V beyond the supply rails should be current-limited to 10mA or less.

(3) Output terminals are diode-clamped to the power-supply rails. Output signals that can swing more than 0.3V beyond the supply rails should be current-limited to  $\pm 55$ mA or less.

(4) Short-circuit from output to  $V_{CC}$  can cause excessive heating and eventual destruction.

(5) The package thermal impedance is calculated in accordance with JEDEC-51.

(6) The maximum power dissipation is a function of  $T_{J(MAX)}$ ,  $R_{\theta JA}$ , and  $T_A$ . The maximum allowable power dissipation at any ambient temperature is  $P_D = (T_{J(MAX)} - T_A) / R_{\theta JA}$ . All numbers apply for packages soldered directly onto a PCB.

### 7.2 ESD Ratings

The following ESD information is provided for handling of ESD-sensitive devices in an ESD protected area only.

			VALUE	UNIT
$V_{(ESD)}$	Electrostatic discharge	Human-Body Model (HBM), per ANSI/ESDA/JEDEC JS-001, all pins <sup>(1)</sup>	$\pm 2000$	V
		Charged-Device Model (CDM), per ANSI/ESDA/JEDEC JS-002 <sup>(2)</sup>	$\pm 1500$	
		Machine Model (MM)	$\pm 200$	

(1) JEDEC document JEP155 states that 500 V HBM allows safe manufacturing with a standard ESD control process.

(2) JEDEC document JEP157 states that 250 V CDM allows safe manufacturing with a standard ESD control process.



### ESD SENSITIVITY CAUTION

ESD damage can range from subtle performance degradation to complete device failure. Precision integrated circuits may be more susceptible to damage because very small parametric changes could cause the device not to meet its published specifications.

### 7.3 Recommended Operating Conditions

Over operating free-air temperature range (unless otherwise noted)

		MIN	NOM	MAX	UNIT
Supply voltage, $V_S= (V+) - (V-)$	Single-supply	3.3		32	V
	Dual-supply	$\pm 1.65$		$\pm 16$	

## 7.4 ELECTRICAL CHARACTERISTICS

(At  $T_A = +25^\circ\text{C}$ ,  $V_{CM}=(V_S/2)$ ,  $V_S=5\text{V}$ , unless otherwise noted.)<sup>(1)</sup>

PARAMETER		CONDITIONS	LM2901			UNITS
			MIN <sup>(2)</sup>	TYP <sup>(3)</sup>	MAX <sup>(2)</sup>	
$V_S$	Operating Voltage Range		3.3		32	V
$I_Q$	Quiescent Current	$V_S=5\text{V}$ , no load		180	360	$\mu\text{A}$
		$V_S=32\text{V}$ , no load, $T_A=-40^\circ\text{C}$ to $+125^\circ\text{C}$		220		
$V_{OS}$	Input offset voltage	$V_S=5\text{V}$ to $32\text{V}$	-4.5	$\pm 0.8$	4.5	mV
		$V_S=5\text{V}$ to $32\text{V}$ $T_A=-40^\circ\text{C}$ to $+125^\circ\text{C}$	-5		5	
$I_B$	Input Bias Current <sup>(4)(5)</sup>	$T_A=25^\circ\text{C}$		10	50	pA
		$T_A=-40^\circ\text{C}$ to $+125^\circ\text{C}$			100	nA
$I_{OS}$	Input Offset Current <sup>(4)</sup>	$T_A=25^\circ\text{C}$		10	50	pA
		$T_A=-40^\circ\text{C}$ to $+125^\circ\text{C}$			100	nA
$V_{CM}$	Common-Mode Voltage Range	$V_S=3.3\text{V}$ to $32\text{V}$	(V-)		(V+)-1.5	V
		$V_S=3.3\text{V}$ to $32\text{V}$ $T_A=-40^\circ\text{C}$ to $+125^\circ\text{C}$	(V-)		(V+)-2.0	
$A_{VD}$	Large signal differential voltage amplification	$V_S=15\text{V}$ , $V_O=1.4\text{V}$ to $11.4\text{V}$ $R_L \geq 15\text{k}$ to (V+)	50	200		V/mV
$V_{OL}$	Low-Level output voltage	$I_{sink} \leq 4\text{mA}$ , $V_{ID}=-1\text{V}$		200	300	mV
$I_{OL}$	Output Current(sinking)	$V_O=1.5\text{V}$ ; $V_{ID}=-1\text{V}$ ; $V_S=5\text{V}$	9	23		mA
$I_{OH-LKG}$	High-Level Output Leakage Current	(V+) = $V_O=5\text{V}$ ; $V_{ID}=1\text{V}$		80	400	nA
		(V+) = $V_O=32\text{V}$ ; $V_{ID}=1\text{V}$		100	500	nA
<b>Switching Characteristics</b>						
$T_{PHL}$	Propagation Delay H To L <sup>(6)</sup>	$V_S=5\text{V}$	RPU=5.1K $\Omega$ , Overdrive =10mV		2.0	$\mu\text{s}$
			RPU=5.1K $\Omega$ , Overdrive =100mV		0.4	
		$V_S=32\text{V}$	RPU=5.1K $\Omega$ , Overdrive =10mV		2.2	
			RPU=5.1K $\Omega$ , Overdrive =100mV		0.4	
$T_{PLH}$	Propagation Delay L To H <sup>(6)</sup>	$V_S=5\text{V}$	RPU=5.1K $\Omega$ , Overdrive =10mV		2.5	
			RPU=5.1K $\Omega$ , Overdrive =100mV		0.8	
		$V_S=32\text{V}$	RPU=5.1K $\Omega$ , Overdrive =10mV		2.2	
			RPU=5.1K $\Omega$ , Overdrive =100mV		0.7	

NOTE:

- (1) Electrical table values apply only for factory testing conditions at the temperature indicated. Factory testing conditions result in very limited self-heating of the device.
- (2) Limits are 100% production tested at  $25^\circ\text{C}$ . Limits over the operating temperature range are ensured through correlations using statistical quality control (SQC) method.
- (3) Typical values represent the most likely parametric norm as determined at the time of characterization. Actual typical values may vary over time and will also depend on the application and configuration.
- (4) This parameter is ensured by design and/or characterization and is not tested in production.
- (5) Positive current corresponds to current flowing into the device.
- (6) High-to-low and low-to-high refers to the transition at the input.

## 7.5 TYPICAL CHARACTERISTICS

NOTE: The graphs and tables provided following this note are a statistical summary based on a limited number of samples and are provided for informational purposes only.

At  $T_A = +25^\circ\text{C}$ ,  $V_S = 5\text{V}$ ,  $R_{PULLUP} = 5.1\text{k}$ ,  $V_{CM} = V_S/2$ ,  $C_L = 15\text{pF}$ , unless otherwise noted.

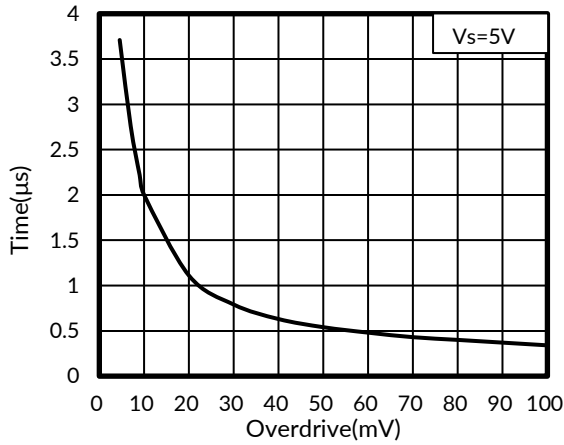

**Figure 1. Response Time vs Input Overdrives Negative Transition**

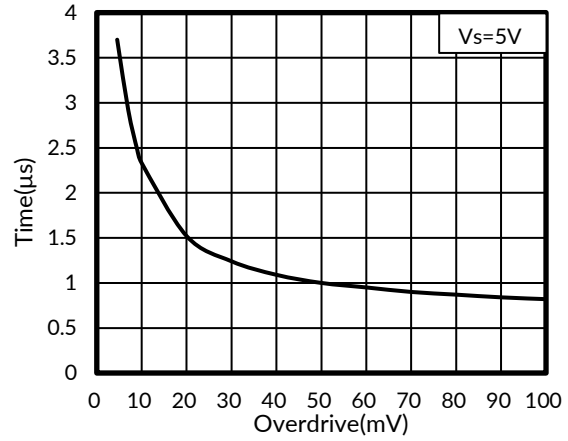

**Figure 2. Response Time vs Input Overdrives Positive Transition**

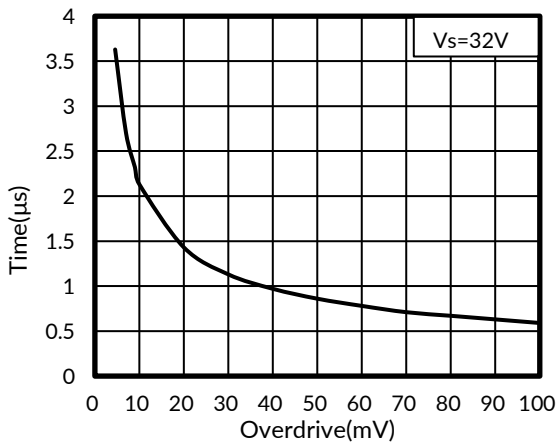

**Figure 3. Response Time vs Input Overdrives Negative Transition**

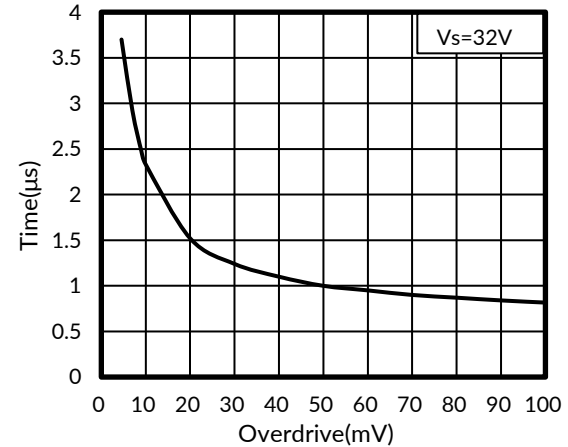

**Figure 4. Response Time vs Input Overdrives Positive Transition**

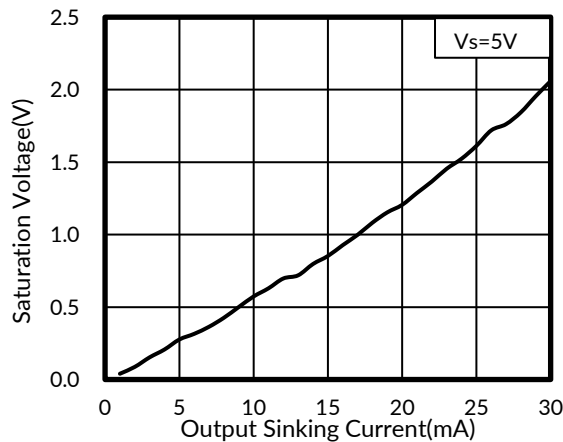

**Figure 5. Saturation Voltage vs Output Sink Current**

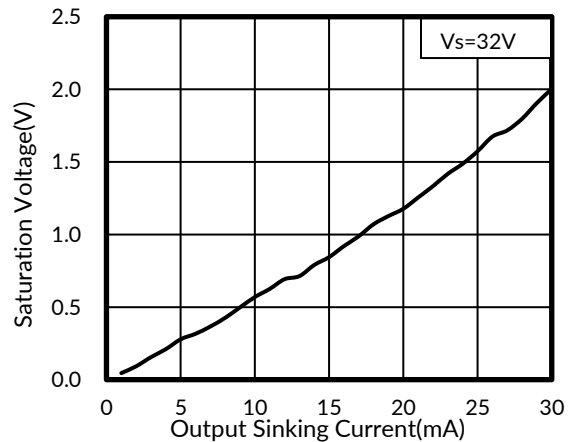

**Figure 6. Saturation Voltage vs Output Sink Current**



## 8 Detailed Description

### 8.1 Overview

The LM2901 family of comparators can operate up to 32V on the supply pin. This standard device has proven ubiquity and versatility across a wide range of applications. This is due to its low power and high speed. The open-drain output allows the user to configure the output's logic low voltage ( $V_{OL}$ ) and can be utilized to enable the comparator to be used in AND functionality.

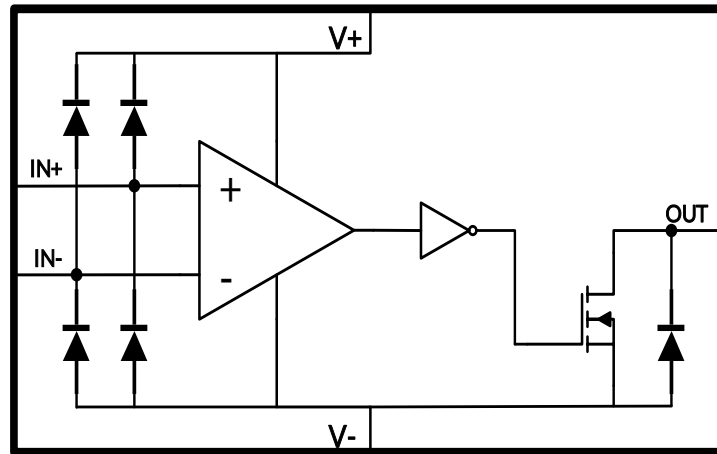

**Figure 7. Functional Block Diagram**

## 9 Application and Implementation

Information in the following applications sections is not part of the Runic component specification, and Runic does not warrant its accuracy or completeness. Runic's customers are responsible for determining suitability of components for their purposes. Customers should validate and test their design implementation to confirm system functionality.

### 9.1 Application Information

LM2901 is typically used to compare a single signal to a reference or two signals against each other. Many users take advantage of the open drain output (logic high with pull-up) to drive the comparison logic output to a logic voltage level to an MCU or logic device. The wide supply range and high voltage capability makes this comparator optimal for level shifting to a higher or lower voltage.

### 9.2 Typical Application

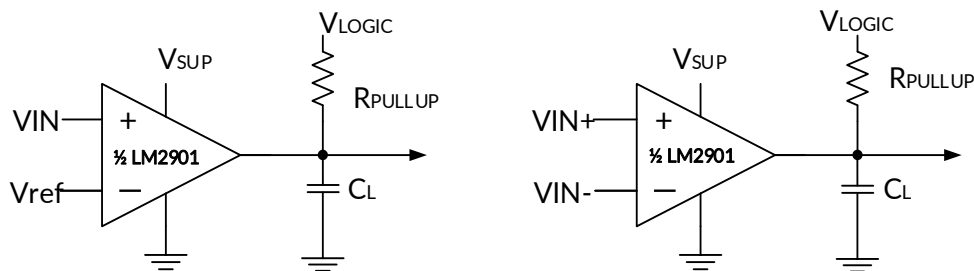

**Figure 8. Single-Ended and Differential Comparator Configurations**

### 9.3 Detailed Design Procedure

When using the device in a general comparator application, determine the following:

- Input Voltage Range
- Minimum Overdrive Voltage
- Output and Drive Current
- Response Time

### 9.4 Input Voltage Range

When choosing the input voltage range, the input common mode voltage range ( $V_{ICR}$ ) must be taken in to account. If temperature operation is below 25°C the  $V_{ICR}$  can range from 0 V to  $V_{CC} - 2.0$  V. This limits the input voltage range to as high as  $V_{CC} - 2.0$  V and as low as 0 V. Operation outside of this range can yield incorrect comparisons.

## 10 Layout

### 10.1 Layout Guidelines

For accurate comparator applications without hysteresis, it is important maintain a stable power supply with minimized noise and glitches. To achieve this, it is best to add a bypass capacitor between the supply voltage and ground. This should be implemented on the positive power supply and negative supply (if available). If a negative supply is not being used, do not put a capacitor between the IC's GND pin and system ground. Minimize coupling between outputs and inverting inputs to prevent output oscillations. Do not run output and inverting input traces in parallel unless there is a  $V_{CC}$  or GND trace between output and inverting input traces to reduce coupling. When series resistance is added to inputs, place resistor close to the device.

### 10.2 Layout Example

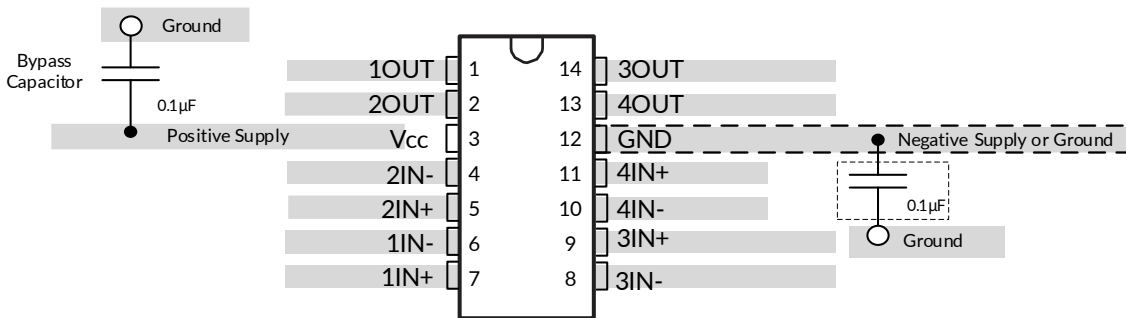

**Figure 9. LM2901 Layout Example**

# 11 PACKAGE OUTLINE DIMENSIONS

## SOP14<sup>(3)</sup>

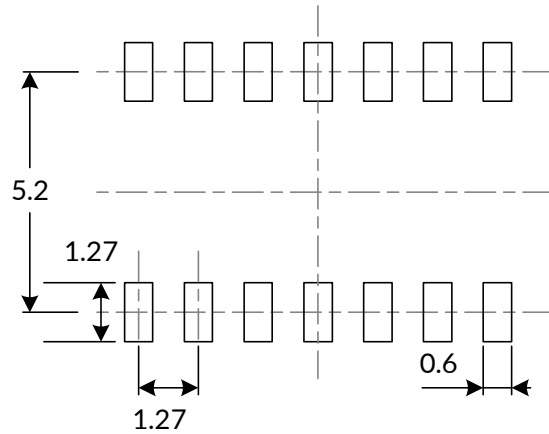
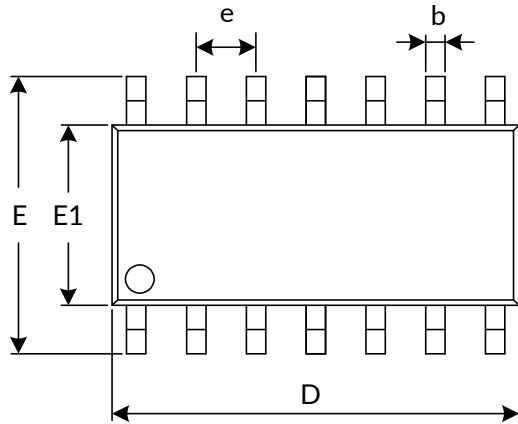
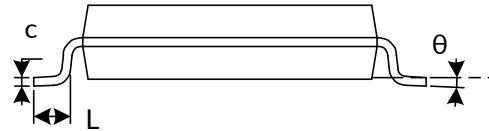
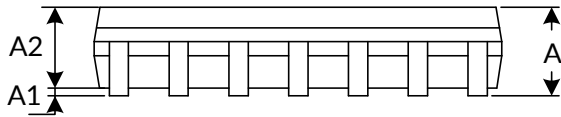
**RECOMMENDED LAND PATTERN** (Unit: mm)

Symbol	Dimensions In Millimeters		Dimensions In Inches	
	Min	Max	Min	Max
A <sup>(1)</sup>	1.350	1.750	0.053	0.069
A1	0.100	0.250	0.004	0.010
A2	1.350	1.550	0.053	0.061
b	0.310	0.510	0.012	0.020
c	0.100	0.250	0.004	0.010
D <sup>(1)</sup>	8.450	8.850	0.333	0.348
e	1.270(BSC) <sup>(2)</sup>		0.050(BSC) <sup>(2)</sup>	
E	5.800	6.200	0.228	0.244
E1 <sup>(1)</sup>	3.800	4.000	0.150	0.157
L	0.400	1.270	0.016	0.050
θ	0°	8°	0°	8°

**NOTE:**

1. Plastic or metal protrusions of 0.15mm maximum per side are not included.
2. BSC (Basic Spacing between Centers), "Basic" spacing is nominal.
3. This drawing is subject to change without notice.

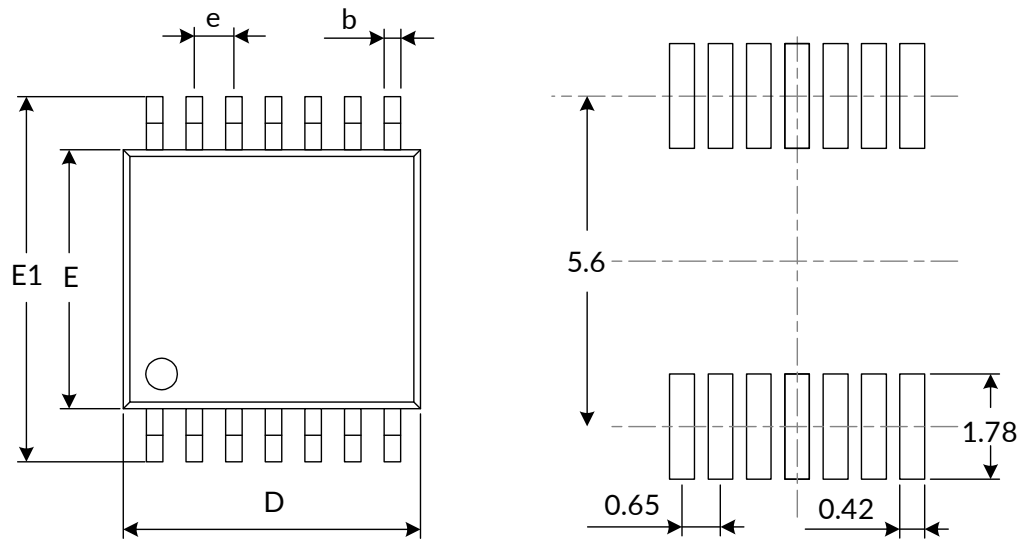
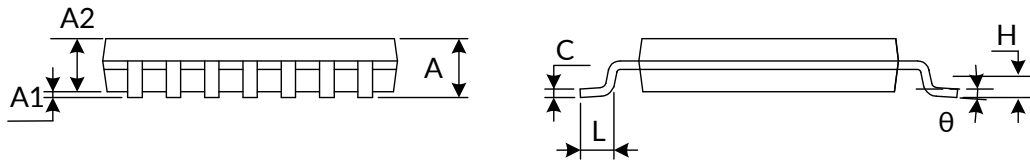
**TSSOP14<sup>(3)</sup>**

**RECOMMENDED LAND PATTERN (Unit: mm)**

Symbol	Dimensions In Millimeters		Dimensions In Inches	
	Min	Max	Min	Max
A <sup>(1)</sup>		1.200		0.047
A1	0.050	0.150	0.002	0.006
A2	0.800	1.050	0.031	0.041
b	0.190	0.300	0.007	0.012
c	0.090	0.200	0.004	0.008
D <sup>(1)</sup>	4.860	5.100	0.191	0.201
E <sup>(1)</sup>	4.300	4.500	0.169	0.177
E1	6.250	6.550	0.246	0.258
e	0.650(BSC) <sup>(2)</sup>		0.026(BSC) <sup>(2)</sup>	
L	0.500	0.700	0.020	0.028
H	0.25(TYP)		0.01(TYP)	
θ	1°	7°	1°	7°

**NOTE:**

1. Plastic or metal protrusions of 0.15mm maximum per side are not included.
2. BSC (Basic Spacing between Centers), "Basic" spacing is nominal.
3. This drawing is subject to change without notice.

## 12 TAPE AND REEL INFORMATION

### REEL DIMENSIONS

### TAPE DIMENSION

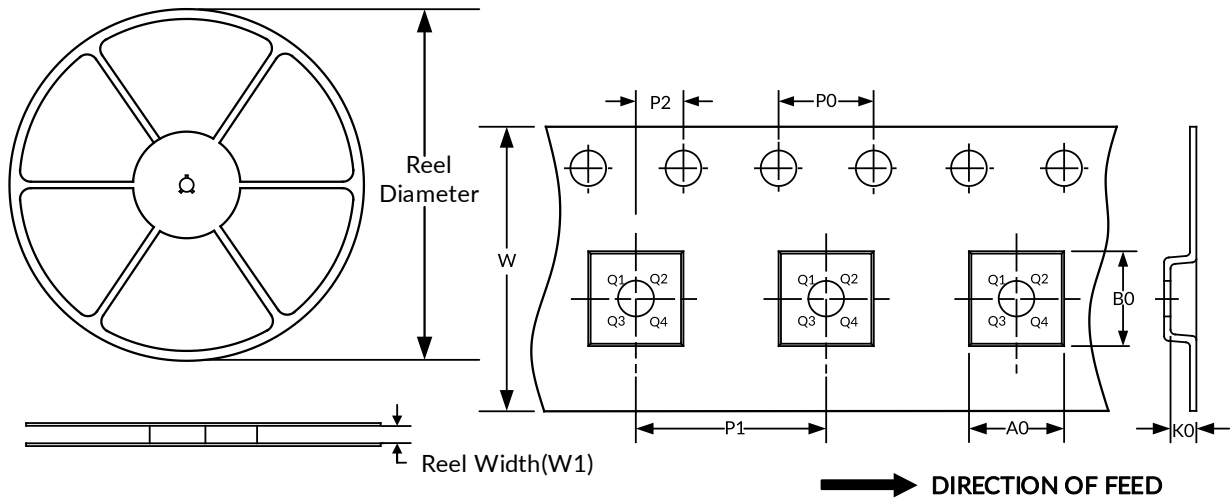

NOTE: The picture is only for reference. Please make the object as the standard.

### KEY PARAMETER LIST OF TAPE AND REEL

Package Type	Reel Diameter	Reel Width (mm)	A0 (mm)	B0 (mm)	K0 (mm)	P0 (mm)	P1 (mm)	P2 (mm)	W (mm)	Pin1 Quadrant
SOP14	13"	16.4	6.60	9.30	2.10	4.0	8.0	2.0	16.0	Q1
TSSOP14	13"	12.4	6.95	5.60	1.20	4.0	8.0	2.0	12.0	Q1

NOTE:

1. All dimensions are nominal.
2. Plastic or metal protrusions of 0.15mm maximum per side are not included.

## IMPORTANT NOTICE AND DISCLAIMER

Jiangsu Runic Technology Co., Ltd. will accurately and reliably provide technical and reliability data (including data sheets), design resources (including reference designs), application or other design advice, WEB tools, safety information and other resources, without warranty of any defect, and will not make any express or implied warranty, including but not limited to the warranty of merchantability Implied warranty that it is suitable for a specific purpose or does not infringe the intellectual property rights of any third party.

These resources are intended for skilled developers designing with Runic products You will be solely responsible for: (1) Selecting the appropriate products for your application; (2) Designing, validating and testing your application; (3) Ensuring your application meets applicable standards and any other safety, security or other requirements; (4) Runic and the Runic logo are registered trademarks of Runic Incorporated. All trademarks are the property of their respective owners; (5) For change details, review the revision history included in any revised document. The resources are subject to change without notice. Our company will not be liable for the use of this product and the infringement of patents or third-party intellectual property rights due to its use.