

RS2G126 Dual Bus Buffer Gate With 3-State Outputs

1 FEATURES

- **Operating Voltage Range: 1.65V to 5.5V**
- **Low Power Consumption: 1µA (Max)**
- **Operating Temperature Range:**
-40°C to +125°C
- **Inputs Accept Voltage to 5.5V**
- **±24mA Output Drive at V_{CC}=3.0V**
- **ESD Protection Exceeds JESD 22**
 - 4000-V Human-Body Model (A114)
 - 200-V Machine Model (A115)
 - 1000-V Charged-Device Model (JS-002)
- **Latch-up Performance Exceeds 100mA**
- **PACKAGE: MSOP8, TSSOP8**

2 APPLICATIONS

- AV Receiver
- Cable Modem Termination Systems
- Digital Picture Frame (DPF)
- High-Speed Data Acquisition and Generation
- Motor Controls: High-Voltage
- Personal Navigation Device (GPS)
- Portable Media Player
- Video Communication Systems

Simplified Schematic

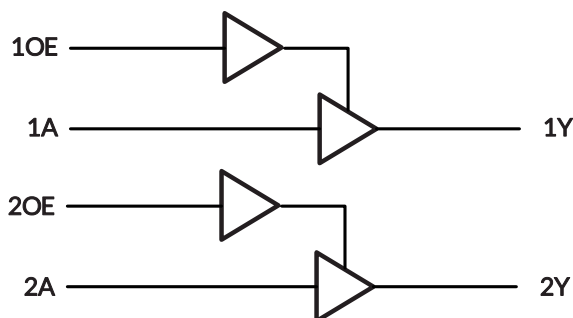

3 DESCRIPTIONS

The dual buffer is designed for 1.65V to 5.5V V_{CC} operation. The RS2G126 device is dual line drivers with 3-state output. The outputs are disabled when the output-enable input is low.

This device is fully specified for partial-power-down applications using I_{off}. The I_{off} circuitry disables the outputs, preventing damaging current backflow through the device when it is powered down.

To ensure the high-impedance state during power up or power down, OE should be tied to GND through a pull-down resistor, the minimum value of the resistor is determined by the current-sourcing capability of the driver.

The RS2G126 is available in Green MSOP8 and TSSOP8 package. It operates over an ambient temperature range of -40°C to +125°C.

Device Information (1)

PART NUMBER	PACKAGE	BODY SIZE (NOM)
RS2G126	MSOP8	3.00mm×3.00mm
	TSSOP8	4.40mm×3.00mm

(1) For all available packages, see the orderable addendum at the end of the data sheet.

4 FUNCTION TABLE

INPUTS		OUTPUT
OE	A	Y
H	H	H
H	L	L
L	X	Z

H=HIGH Logic Level
L=LOW Logic Level
X=Don't Care
Z=High-impedance OFF-state

Table of Contents

1 FEATURES	1
2 APPLICATIONS	1
3 DESCRIPTIONS	1
4 FUNCTION TABLE	1
5 Revision History	3
6 PACKAGE/ORDERING INFORMATION ⁽¹⁾	4
7 PIN CONFIGURATIONS	5
8 Specifications	6
8.1 Absolute Maximum Ratings ⁽¹⁾	6
8.2 ESD Ratings	6
9 ELECTRICAL CHARACTERISTICS	7
9.1 Recommended Operating Conditions	7
9.2 DC Characteristics	8
9.3 Switching Characteristics, C _L =15pF	9
9.4 Switching Characteristics, C _L =30pF or 50pF	9
9.5 Operating Characteristics	9
10 Parameter Measurement Information	10
11 PACKAGE OUTLINE DIMENSIONS	11
12 TAPE AND REEL INFORMATION	13

5 Revision History

Note: Page numbers for previous revisions may differ from page numbers in the current version.

Version	Change Date	Change Item
A.1	2021/02/05	Initial version completed
A.2	2021/12/22	Added the TAPE AND REEL INFORMATION
A.3	2022/09/01	1. Change TSSOP8 package to MSOP8 package 2. Change ORDERING NUMBER
A.4	2022/10/28	1. Add TSSOP-8 package 2. Change ESD Ratings
A.5	2024/01/12	1. Update FEATURES on Page 1@RevA.4 2. Add MSL on Page 4@RevA.4 3. Update Package thermal impedance and ESD Ratings on Page 6@RevA.4
A.5.1	2024/02/29	Modify packaging naming

6 PACKAGE/ORDERING INFORMATION ⁽¹⁾

PRODUCT	ORDERING NUMBER	TEMPERATURE RANGE	PACKAGE LEAD	PACKAGE MARKING ⁽²⁾	MSL ⁽³⁾	PACKAGE OPTION
RS2G126	RS2G126XM	-40°C ~+125°C	MSOP8	RS2G126	MSL3	Tape and Reel,4000
	RS2G126XQ	-40°C ~+125°C	TSSOP8	RS2G126	MSL3	Tape and Reel,4000

NOTE:

- (1) This information is the most current data available for the designated devices. This data is subject to change without notice and revision of this document. For browser-based versions of this data sheet, refer to the right-hand navigation.
- (2) There may be additional marking, which relates to the lot trace code information (data code and vendor code), the logo or the environmental category on the device.
- (3) MSL, The Moisture Sensitivity Level rating according to the JEDEC industry standard classifications.

7 PIN CONFIGURATIONS

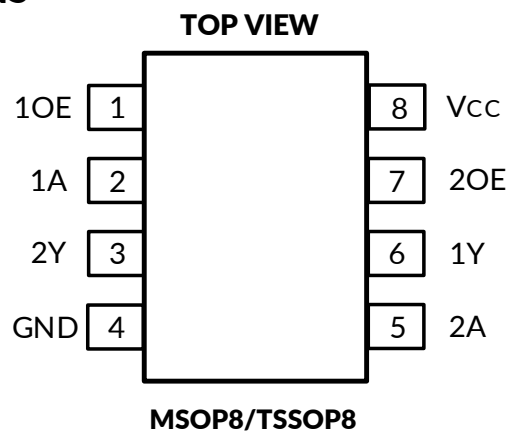

PIN DESCRIPTION

PIN	NAME	I/O TYPE ⁽¹⁾	FUNCTION
1	1OE	I	Output Enable for buffer 1
2	1A	I	Input of buffer 1
3	2Y	O	Output of buffer 2
4	GND	-	Ground
5	2A	I	Input of buffer 2
6	1Y	O	Output of buffer 1
7	2OE	I	Output Enable for buffer 2
8	V _{cc}	-	Power Pin

(1) I=input, O=output.

8 Specifications

8.1 Absolute Maximum Ratings ⁽¹⁾

over operating free-air temperature range (unless otherwise noted) ^{(1) (2)}

		MIN	MAX	UNIT
V _{CC}	Supply voltage range	-0.5	6.5	V
V _I	Input voltage range ⁽²⁾	-0.5	6.5	V
V _O	Voltage range applied to any output in the high-impedance or power-off state ⁽²⁾	-0.5	6.5	V
V _O	Voltage range applied to any output in the high or low state ^{(2) (3)}	-0.5	V _{CC} +0.5	V
I _{IK}	Input clamp current	V _I <0	-50	mA
I _{OK}	Output clamp current	V _O <0	-50	mA
I _O	Continuous output current		±50	mA
	Continuous current through V _{CC} or GND		±100	mA
θ _{JA}	Package thermal impedance ⁽⁴⁾	MSOP8	199	°C/W
		TSSOP8	240	
T _J	Junction temperature ⁽⁵⁾	-65	150	°C
T _{stg}	Storage temperature	-65	150	°C

(1) Stresses beyond those listed under Absolute Maximum Ratings may cause permanent damage to the device. These are stress ratings only, and functional operation of the device at these or any other conditions beyond those indicated under Recommended Operating Conditions is not implied. Exposure to absolute-maximum-rated conditions for extended periods may affect device reliability.

(2) The input and output negative-voltage ratings may be exceeded if the input and output current ratings are observed.

(3) The value of V_{CC} is provided in the Recommended Operating Conditions table.

(4) The package thermal impedance is calculated in accordance with JESD-51.

(5) The maximum power dissipation is a function of T_{J(MAX)}, R_{θJA}, and T_A. The maximum allowable power dissipation at any ambient temperature is P_D = (T_{J(MAX)} - T_A) / R_{θJA}. All numbers apply for packages soldered directly onto a PCB.

8.2 ESD Ratings

The following ESD information is provided for handling of ESD-sensitive devices in an ESD protected area only.

		VALUE	UNIT
V _(ESD)	Electrostatic discharge		
	Human-body model (HBM), per ANSI/ESDA/JEDEC JS-001 ⁽¹⁾	±4000	V
	Charged-device model (CDM)	±1000	V
	Machine model (MM)	±200	V

(1) JEDEC document JEP155 states that 500 V HBM allows safe manufacturing with a standard ESD control process.



ESD SENSITIVITY CAUTION

ESD damage can range from subtle performance degradation to complete device failure. Precision integrated circuits may be more susceptible to damage because very small parametric changes could cause the device not to meet its published specifications.

9 ELECTRICAL CHARACTERISTICS

over recommended operating free-air temperature range (TYP values are at $T_A = +25^{\circ}\text{C}$, unless otherwise noted.)⁽¹⁾

9.1 Recommended Operating Conditions

PARAMETER	SYMBOL	TEST CONDITIONS	MIN	MAX	UNIT
Supply voltage	V_{CC}	Operating	1.65	5.5	V
		Data retention only	1.5	5.5	
High-level input voltage	V_{IH}	$V_{CC}=1.65\text{V to }1.95\text{V}$	$0.65 \times V_{CC}$		V
		$V_{CC}=2.3\text{V to }2.7\text{V}$	1.7		
		$V_{CC}=3\text{V to }3.6\text{V}$	2.2		
		$V_{CC}=4.5\text{V to }5.5\text{V}$	$0.7 \times V_{CC}$		
Low-level input voltage	V_{IL}	$V_{CC}=1.65\text{V to }1.95\text{V}$		$0.15 \times V_{CC}$	V
		$V_{CC}=2.3\text{V to }2.7\text{V}$		0.3	
		$V_{CC}=3\text{V to }3.6\text{V}$		0.4	
		$V_{CC}=4.5\text{V to }5.5\text{V}$		$0.15 \times V_{CC}$	
Input voltage	V_I		0	5.5	V
Output voltage	V_O		0	V_{CC}	V
Input transition rise or fall	t_r, t_f	$V_{CC}=1.8\text{V} \pm 0.15\text{V}, 2.5\text{V} \pm 0.2\text{V}$		20	ns/V
		$V_{CC}=3.3\text{V} \pm 0.3\text{V}$		10	
		$V_{CC}=5\text{V} \pm 0.5\text{V}$		5	
Operating temperature	T_A		-40	+125	$^{\circ}\text{C}$

(1) All unused inputs of the device must be held at V_{CC} or GND to ensure proper device operation.

9.2 DC Characteristics

PARAMETER		TEST CONDITIONS	V _{CC}	TEMP	MIN ⁽²⁾	TYP ⁽³⁾	MAX ⁽²⁾	UNIT
V _{OH}		I _{OH} = -100μA	1.65V to 5.5V	Full	V _{CC} -0.1			V
		I _{OH} = -4mA	1.65V		1.2			
		I _{OH} = -8mA	2.3V		1.9			
		I _{OH} = -16mA	3V		2.4			
		I _{OH} = -24mA			2.3			
		I _{OH} = -32mA	4.5V		3.8			
V _{OL}		I _{OL} = 100μA	1.65V to 5.5V	Full			0.1	V
		I _{OL} = 4mA	1.65V				0.45	
		I _{OL} = 8mA	2.3V				0.3	
		I _{OL} = 16mA	3V				0.4	
		I _{OL} = 24mA					0.55	
		I _{OL} = 32mA	4.5V				0.55	
I _i	A or OE inputs	V _i =5.5V or GND	0V to 5.5V	+25°C		±0.1	±1	μA
				Full			±5	
	I _{off}	V _i or V _o =5.5V	0V	+25°C		±0.1	±1	μA
				Full			±10	
	I _{oz}	V _o =0V to 5.5V	3.6V	Full			10	μA
	I _{CC}	V _i =5.5V or GND, I _o =0	1.65V to 5.5V	+25°C		0.1	1	μA
				Full			10	
	ΔI _{CC}	One input at V _{CC} -0.6V, Other inputs at V _{CC} or GND	3V to 5.5V	Full			500	μA

- (1) All unused inputs of the device must be held at V_{CC} or GND to ensure proper device operation.
- (2) Limits are 100% production tested at 25°C. Limits over the operating temperature range are ensured through correlations using statistical quality control (SQC) method.
- (3) Typical values represent the most likely parametric norm as determined at the time of characterization. Actual typical values may vary over time and will also depend on the application and configuration.

9.3 Switching Characteristics, $C_L=15\text{pF}$

over recommended operating free-air temperature range (-40°C to 125°C, unless otherwise noted.)⁽¹⁾

PARAMETER	FROM (INPUT)	TO (OUTPUT)	V _{CC} =1.8V±0.15V	V _{CC} =2.5V±0.2V	V _{CC} =3.3V±0.3V	V _{CC} =5V±0.5V	UNIT
			TYP	TYP	TYP	TYP	
t _{pd}	A	Y	6.1	3.7	3.9	2.1	ns

(1) All unused inputs of the device must be held at V_{CC} or GND to ensure proper device operation.

9.4 Switching Characteristics, $C_L=30\text{pF}$ or 50pF

over recommended operating free-air temperature range (-40°C to 125°C, unless otherwise noted.)⁽¹⁾

PARAMETER	FROM (INPUT)	TO (OUTPUT)	V _{CC} =1.8V±0.15V	V _{CC} =2.5V±0.2V	V _{CC} =3.3V±0.3V	V _{CC} =5V±0.5V	UNIT
			TYP	TYP	TYP	TYP	
t _{pd}	A	Y	8.6	5.3	4.0	2.9	ns
t _{en}	OE	Y	9.5	5.8	5.0	3.3	ns
t _{dis}	OE	Y	7.4	4.3	4.4	3.0	ns

(1) All unused inputs of the device must be held at V_{CC} or GND to ensure proper device operation.

9.5 Operating Characteristics

T_A=25°C

PARAMETER			TEST CONDITIONS	V _{CC} =1.8V	V _{CC} =2.5V	V _{CC} =3.3V	V _{CC} =5V	UNIT
				TYP	TYP	TYP	TYP	
C _{pd}	Power dissipation capacitance	Output enabled	f=10MHz	18	18	18	21	pF
		Output disabled		2	2	3	4	

10 Parameter Measurement Information

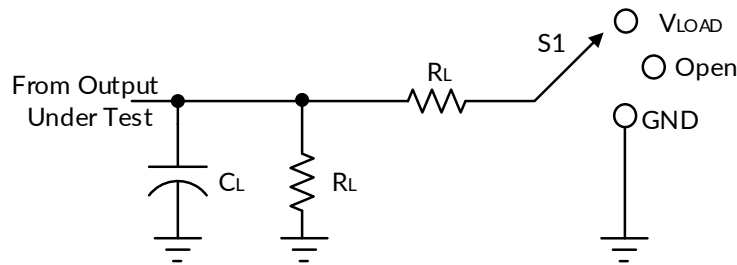

TEST	S1
t _{PLH} /t _{PHL}	Open
t _{PLZ} /t _{PZL}	V _{LOAD}
t _{PHZ} /t _{PZH}	GND

V _{CC}	INPUTS		V _M	V _{LOAD}	C _L		R _L		V _Δ
	V _I	t _r /t _f							
1.8V±0.15V	V _{CC}	≤2ns	V _{CC} /2	2 x V _{CC}	15pF	30pF	1MΩ	1kΩ	0.15V
2.5V±0.2V	V _{CC}	≤2ns	V _{CC} /2	2 x V _{CC}	15pF	30pF	1MΩ	500Ω	0.15V
3.3V±0.3V	3V	≤2.5ns	1.5V	6V	15pF	50pF	1MΩ	500Ω	0.3V
5V±0.5V	V _{CC}	≤2.5ns	V _{CC} /2	2 x V _{CC}	15pF	50pF	1MΩ	500Ω	0.3V

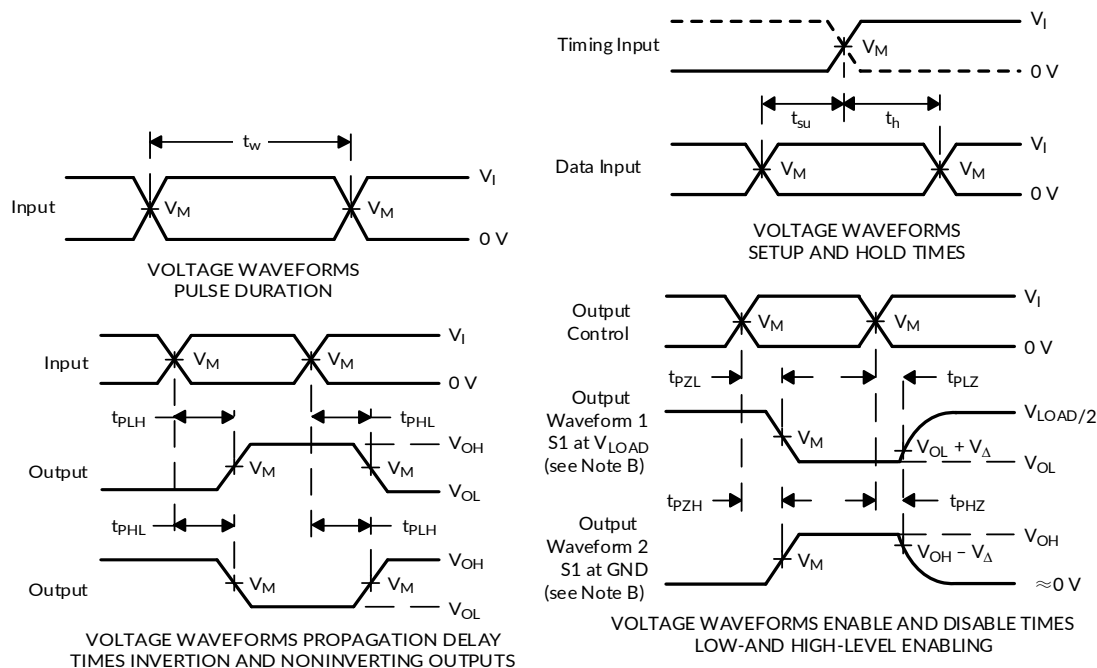

- NOTES:
- A. C_L includes probe and jig capacitance.
 - B. Waveform 1 is for an output with internal conditions such that the output is low, except when disabled by the output control. Waveform 2 is for an output with internal conditions such that the output is high, except when disabled by the output control.
 - C. All input pulses are supplied by generators having the following characteristics: PRR ≤ 10 MHz, Z_o = 50 Ω.
 - D. The outputs are measured one at a time, with one transition per measurement.
 - E. t_{PZL} and t_{PHZ} are the same as t_{dis}.
 - F. t_{PZL} and t_{PZH} are the same as t_{en}.
 - G. t_{PLH} and t_{PHL} are the same as t_{pd}.
 - H. All parameters and waveforms are not applicable to all devices.

Figure 1. Load Circuit and Voltage Waveforms

11 PACKAGE OUTLINE DIMENSIONS

MSOP8⁽³⁾

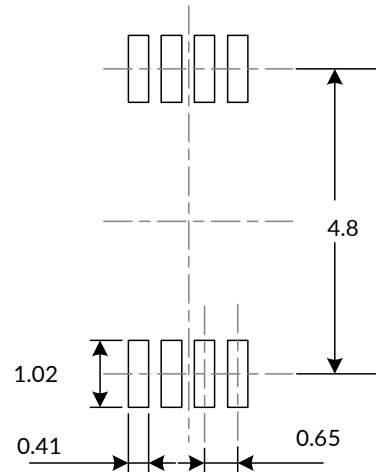
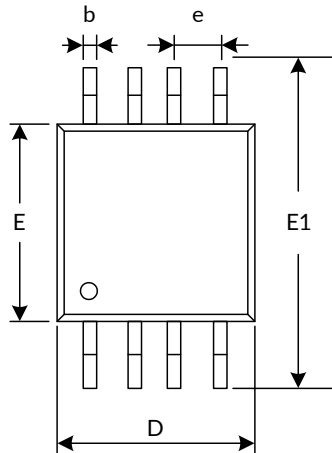

RECOMMENDED LAND PATTERN (Unit: mm)

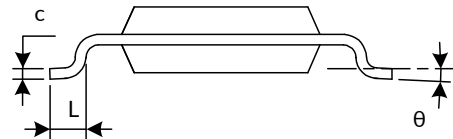
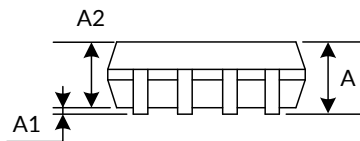

Symbol	Dimensions In Millimeters		Dimensions In Inches	
	Min	Max	Min	Max
A ⁽¹⁾	0.820	1.100	0.032	0.043
A1	0.020	0.150	0.001	0.006
A2	0.750	0.950	0.030	0.037
b	0.250	0.380	0.010	0.015
c	0.090	0.230	0.004	0.009
D ⁽¹⁾	2.900	3.100	0.114	0.122
e	0.650(BSC) ⁽²⁾		0.026(BSC) ⁽²⁾	
E ⁽¹⁾	2.900	3.100	0.114	0.122
E1	4.750	5.050	0.187	0.199
L	0.400	0.800	0.016	0.031
θ	0°	6°	0°	6°

NOTE:

1. Plastic or metal protrusions of 0.15mm maximum per side are not included.
2. BSC (Basic Spacing between Centers), "Basic" spacing is nominal.
3. This drawing is subject to change without notice.

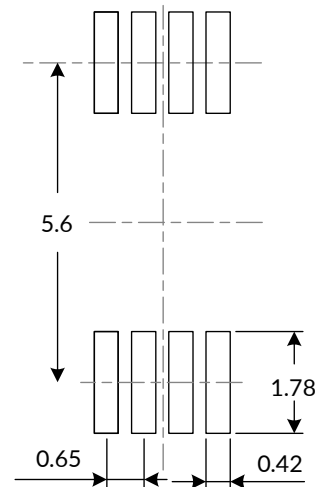
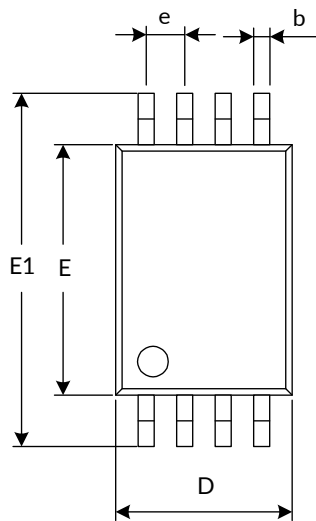
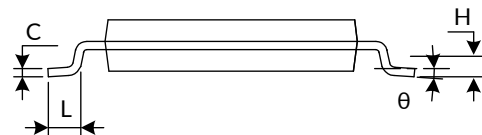
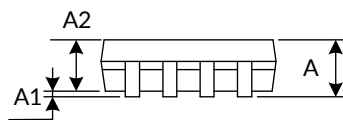
TSSOP8⁽³⁾

RECOMMENDED LAND PATTERN (Unit: mm)

Symbol	Dimensions In Millimeters		Dimensions In Inches	
	Min	Max	Min	Max
A ⁽¹⁾		1.200		0.047
A1	0.050	0.150	0.002	0.006
A2	0.800	1.050	0.031	0.041
b	0.190	0.300	0.007	0.012
c	0.090	0.200	0.004	0.008
D ⁽¹⁾	2.900	3.100	0.114	0.122
E ⁽¹⁾	4.300	4.500	0.169	0.177
E1	6.250	6.550	0.246	0.258
e	0.650(BSC) ⁽²⁾		0.026(BSC) ⁽²⁾	
L	0.500	0.700	0.020	0.028
H	0.25(TYP)		0.01(TYP)	
θ	1°	7°	1°	7°

NOTE:

1. Plastic or metal protrusions of 0.15mm maximum per side are not included.
2. BSC (Basic Spacing between Centers), "Basic" spacing is nominal.
3. This drawing is subject to change without notice.

12 TAPE AND REEL INFORMATION

REEL DIMENSIONS

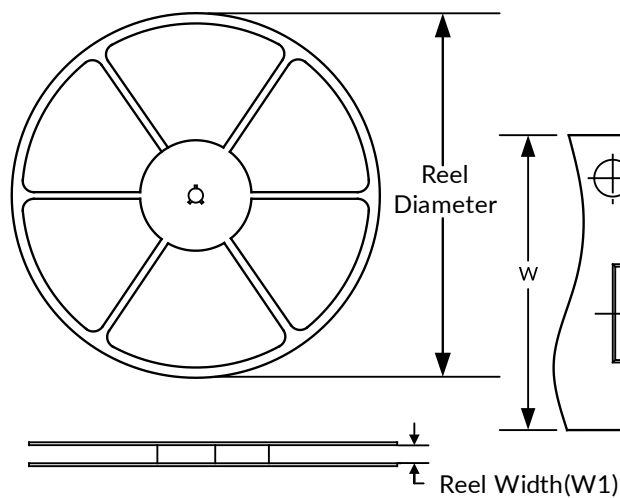

TAPE DIMENSION

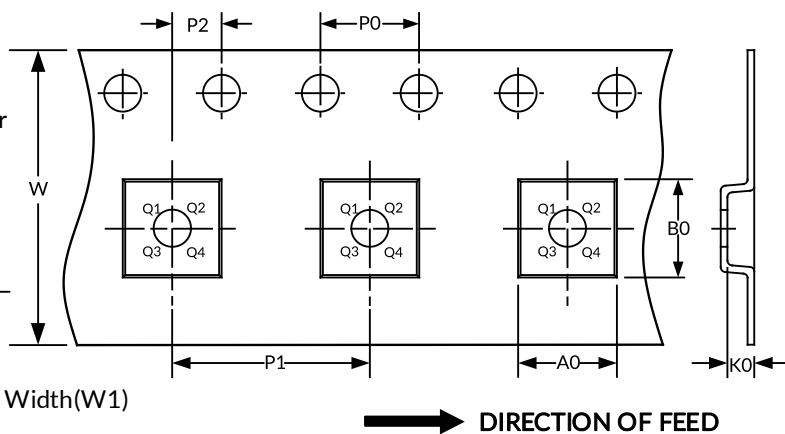

NOTE: The picture is only for reference. Please make the object as the standard.

KEY PARAMETER LIST OF TAPE AND REEL

Package Type	Reel Diameter	Reel Width(mm)	A0 (mm)	B0 (mm)	K0 (mm)	P0 (mm)	P1 (mm)	P2 (mm)	W (mm)	Pin1 Quadrant
MSOP8	13"	12.4	5.20	3.30	1.50	4.0	8.0	2.0	12.0	Q1
TSSOP8	13"	12.4	6.90	3.45	1.65	4.0	8.0	2.0	12.0	Q1

NOTE:

1. All dimensions are nominal.
2. Plastic or metal protrusions of 0.15mm maximum per side are not included.

IMPORTANT NOTICE AND DISCLAIMER

Jiangsu Runic Technology Co., Ltd. will accurately and reliably provide technical and reliability data (including data sheets), design resources (including reference designs), application or other design advice, WEB tools, safety information and other resources, without warranty of any defect, and will not make any express or implied warranty, including but not limited to the warranty of merchantability Implied warranty that it is suitable for a specific purpose or does not infringe the intellectual property rights of any third party.

These resources are intended for skilled developers designing with Runic products You will be solely responsible for: (1) Selecting the appropriate products for your application; (2) Designing, validating and testing your application; (3) Ensuring your application meets applicable standards and any other safety, security or other requirements; (4) Runic and the Runic logo are registered trademarks of Runic Incorporated. All trademarks are the property of their respective owners; (5) For change details, review the revision history included in any revised document. The resources are subject to change without notice. Our company will not be liable for the use of this product and the infringement of patents or third-party intellectual property rights due to its use.