

7MHz, Rail-to-Rail I/O CMOS Operational Amplifier

1 FEATURES

- **HIGH GAIN BANDWIDTH:7MHz**
- **RAIL-TO-RAIL INPUT AND OUTPUT**
±0.7mV Typical Vos
- **INPUT VOLTAGE RANGE: -0.1V to +5.6V**
with Vs = 5.5V
- **SUPPLY RANGE: +2.5V to +5.5V**
- **SPECIFIED UP TO +125°C**

2 APPLICATIONS

- **SENSORS**
- **PHOTODIODE AMPLIFICATION**
- **ACTIVE FILTERS**
- **TEST EQUIPMENT**
- **DRIVING A/D CONVERTERS**

3 DESCRIPTIONS

The RS622A families of products offer low voltage operation and rail-to-rail input and output, as well as excellent speed/power consumption ratio, providing an excellent bandwidth (7MHz) and slew rate of 3.7V/us. The op-amps are unity gain stable and feature an ultra-low input bias current.

The devices are ideal for sensor interfaces, active filters and portable applications. The RS622A families of operational amplifiers are specified at the full temperature range of -40°C to +125°C under single or dual power supplies of 2.5V to 5.5V.

Device Information ⁽¹⁾

PART NUMBER	PACKAGE	BODY SIZE(NOM)
RS622A	SOP8	4.90mm×3.90mm
	MSOP8	3.00mm×3.00mm
	TSSOP8	3.00mm×4.40mm

(1) For all available packages, see the orderable addendum at the end of the data sheet

Table of Contents

1 FEATURES	1
2 APPLICATIONS	1
3 DESCRIPTIONS	1
4 Revision History	3
5 PACKAGE/ORDERING INFORMATION ⁽¹⁾	4
6 Pin Configuration and Functions (Top View)	5
7 SPECIFICATIONS	6
7.1 Absolute Maximum Ratings	6
7.2 ESD Ratings	6
7.3 Recommended Operating Conditions	6
7.4 ELECTRICAL CHARACTERISTICS	7
7.5 TYPICAL CHARACTERISTICS	9
8 Application and Implementation	12
8.1 APPLICATION NOTES	12
8.2 LAYOUT GUIDELINS	12
8.3 INSTRUMENTATION AMPLIFIER	12
9 PACKAGE OUTLINE DIMENSIONS	13
10 TAPE AND REEL INFORMATION	16

4 Revision History

Note: Page numbers for previous revisions may differ from page numbers in the current version.

VERSION	Change Date	Change Item
B.2	2020/12/02	1. Added SOIC-8(SOP8) and MSOP-8 package 2. Update Package Qty on Page 2@RevB.1
C.1	2023/09/22	1. Add the TAPE AND REEL INFORMATION 2. Add ELECTRICAL CHARACTERISTICS
C.2	2024/01/30	1. Update ELECTRICAL CHARACTERISTICS values on Page 7@RevC.1 2. Add MSL on Page 4@RevC.1
C.2.1	2024/02/29	Modify packaging naming

5 PACKAGE/ORDERING INFORMATION ⁽¹⁾

Orderable Device	Package Type	Pin	Channel	Op Temp(°C)	Device Marking ⁽²⁾	MSL ⁽³⁾	Package Qty
RS622AXK	SOP8	8	2	-40°C ~125°C	RS622A	MSL3	Tape and Reel,4000
RS622AXM	MSOP8	8	2	-40°C ~125°C	RS622A	MSL3	Tape and Reel,4000
RS622AXQ	TSSOP8	8	2	-40°C ~125°C	RS622A	MSL3	Tape and Reel,4000

NOTE:

- (1) This information is the most current data available for the designated devices. This data is subject to change without notice and revision of this document. For browser-based versions of this data sheet, refer to the right-hand navigation.
- (2) There may be additional marking, which relates to the lot trace code information (data code and vendor code), the logo or the environmental category on the device.
- (3) MSL, The Moisture Sensitivity Level rating according to the JEDEC industry standard classifications.

6 Pin Configuration and Functions (Top View)

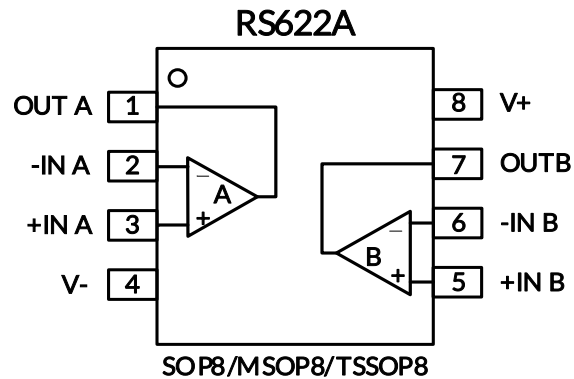

Pin Description

NAME	PIN	I/O ⁽¹⁾	DESCRIPTION
	SOP8/MSOP8/TSSOP8		
-INA	2	I	Inverting input, channel A
+INA	3	I	Noninverting input, channel A
-INB	6	I	Inverting input, channel B
+INB	5	I	Noninverting input, channel B
OUTA	1	O	Output, channel A
OUTB	7	O	Output, channel B
V-	4	-	Negative (lowest) power supply
V+	8	-	Positive (highest) power supply

(1) I = Input, O = Output.

7 SPECIFICATIONS

7.1 Absolute Maximum Ratings

Over operating free-air temperature range (unless otherwise noted) ⁽¹⁾

		MIN	MAX	UNIT
Voltage	Supply, $V_S=(V+) - (V-)$		7	V
	Signal input pin ⁽²⁾	(V-)-0.5	(V+) +0.5	
	Signal output pin ⁽³⁾	(V-)-0.5	(V+) +0.5	
Current	Signal input pin ⁽²⁾	-10	10	mA
	Signal output pin ⁽³⁾	-200	200	mA
	Output short-circuit ⁽⁴⁾	Continuous		
θ_{JA}	Package thermal impedance ⁽⁵⁾	SOP8	110	°C/W
		MSOP8	170	
		TSSOP8	240	
Temperature	Operating range, T_A	-40	125	°C
	Junction, T_J ⁽⁶⁾	-40	150	
	Storage, T_{stg}	-65	150	

- (1) Stresses above these ratings may cause permanent damage. Exposure to absolute maximum conditions for extended periods may degrade device reliability. These are stress ratings only, and functional operation of the device at these or any other conditions beyond those specified is not implied.
- (2) Input terminals are diode-clamped to the power-supply rails. Input signals that can swing more than 0.5V beyond the supply rails should be current-limited to 10mA or less.
- (3) Output terminals are diode-clamped to the power-supply rails. Output signals that can swing more than 0.5V beyond the supply rails should be current-limited to ± 200 mA or less.
- (4) Short-circuit to ground, one amplifier per package.
- (5) The package thermal impedance is calculated in accordance with JEDEC-51.
- (6) The maximum power dissipation is a function of $T_{J(MAX)}$, $R_{\theta JA}$, and T_A . The maximum allowable power dissipation at any ambient temperature is $P_D = (T_{J(MAX)} - T_A) / R_{\theta JA}$. All numbers apply for packages soldered directly onto a PCB.

7.2 ESD Ratings

The following ESD information is provided for handling of ESD-sensitive devices in an ESD protected area only.

			VALUE	UNIT
$V_{(ESD)}$	Electrostatic discharge	Human-body model (HBM)	± 5000	V
		Machine Model (MM)	± 400	



ESD SENSITIVITY CAUTION

ESD damage can range from subtle performance degradation to complete device failure. Precision integrated circuits may be more susceptible to damage because very small parametric changes could cause the device not to meet its published specifications.

7.3 Recommended Operating Conditions

Over operating free-air temperature range (unless otherwise noted)

		MIN	NOM	MAX	UNIT
Supply voltage, $V_S=(V+) - (V-)$	Single-supply	2.5		5.5	V
	Dual-supply	± 1.25		± 2.75	

7.4 ELECTRICAL CHARACTERISTICS

(At $T_A = +25^\circ\text{C}$, $V_S = 5\text{V}$, $R_L = 10\text{k}\Omega$ connected to $V_S/2$, and $V_{OUT} = V_S/2$, $V_{CM} = V_S/2$, Full ⁽⁹⁾ = -40°C to $+125^\circ\text{C}$, unless otherwise noted.) ⁽¹⁾

PARAMETER		CONDITIONS	T_J	RS622A			
				MIN ⁽²⁾	TYP ⁽³⁾	MAX ⁽²⁾	UNIT
POWER SUPPLY							
V_S	Operating Voltage Range		25°C	2.5		5.5	V
I_Q	Quiescent Current Per Amplifier		25°C		750	1200	uA
PSRR	Power-Supply Rejection Ratio	$V_S = 2.5\text{V to } 5.5\text{V}$, $V_{CM} = (V_-) + 0.5\text{V}$	25°C	75	93		dB
			Full	72			
INPUT							
V_{OS}	Input Offset Voltage	$V_{CM} = V_S/2$	25°C	-3	± 0.7	3	mV
$V_{OS} T_C$	Input Offset Voltage Average Drift	$V_{CM} = V_S/2$	Full		± 2		$\mu\text{V}/^\circ\text{C}$
I_B	Input Bias Current ^{(4) (5)}		25°C		± 1	± 10	pA
I_{OS}	Input Offset Current ⁽⁴⁾		25°C		± 1	± 10	pA
V_{CM}	Common-Mode Voltage Range	$V_S = 5.5\text{V}$	25°C	-0.1		5.6	V
CMRR	Common-Mode Rejection Ratio	$V_S = 5.5\text{V}$ $V_{CM} = -0.1\text{V to } 4\text{V}$	25°C	74	92		dB
			Full	68			
		$V_S = 5.5\text{V}$ $V_{CM} = -0.1\text{V to } 5.6\text{V}$	25°C	62	83		
			Full	60			
OUTPUT							
A_{OL}	Open-Loop Voltage Gain	$R_L = 2\text{k}\Omega$, $V_O = 0.15\text{V to } 4.85\text{V}$	25°C	85	102		dB
			Full	75			
		$R_L = 10\text{k}\Omega$, $V_O = 0.05\text{V to } 4.95\text{V}$	25°C	88	106		
			Full	78			
	Output Swing From Rail	$R_L = 2\text{k}\Omega$	25°C		40		mV
		$R_L = 10\text{k}\Omega$			7		
I_{OUT}	Output Short-Circuit Current ^{(6) (7)}		25°C	± 140	± 180		mA
FREQUENCY RESPONSE							
SR	Slew Rate ⁽⁸⁾		25°C		3.7		V/us
GBP	Gain-Bandwidth Product		25°C		7		MHz
PM	Phase Margin		25°C		64		°
t_s	Settling Time, 0.1%				0.5		us
	Overload Recovery Time	$V_{IN} \cdot \text{Gain} \geq V_S$			0.5		us
NOISE							
e_n	Input Voltage Noise Density	$f = 1\text{KHz}$	25°C		11		$\text{nV}/\sqrt{\text{Hz}}$
		$f = 10\text{KHz}$	25°C		7.5		$\text{nV}/\sqrt{\text{Hz}}$

NOTE:

- (1) Electrical table values apply only for factory testing conditions at the temperature indicated. Factory testing conditions result in very limited self-heating of the device.
- (2) Limits are 100% production tested at 25°C. Limits over the operating temperature range are ensured through correlations using statistical quality control (SQC) method.
- (3) Typical values represent the most likely parametric norm as determined at the time of characterization. Actual typical values may vary over time and will also depend on the application and configuration.
- (4) This parameter is ensured by design and/or characterization and is not tested in production.
- (5) Positive current corresponds to current flowing into the device.
- (6) The maximum power dissipation is a function of $T_{J(MAX)}$, $R_{\theta JA}$, and T_A . The maximum allowable power dissipation at any ambient temperature is $PD = (T_{J(MAX)} - T_A) / R_{\theta JA}$. All numbers apply for packages soldered directly onto a PCB.
- (7) Short circuit test is a momentary test.
- (8) Number specified is the slower of positive and negative slew rates.
- (9) Specified by characterization only.

7.5 TYPICAL CHARACTERISTICS

NOTE: The graphs and tables provided following this note are a statistical summary based on a limited number of samples and are provided for informational purposes only.

At $T_A = +25^\circ\text{C}$, $V_S = 5\text{V}$, $R_L = 10\text{k}\Omega$ connected to $V_S/2$, $V_{OUT} = V_S/2$, unless otherwise noted.

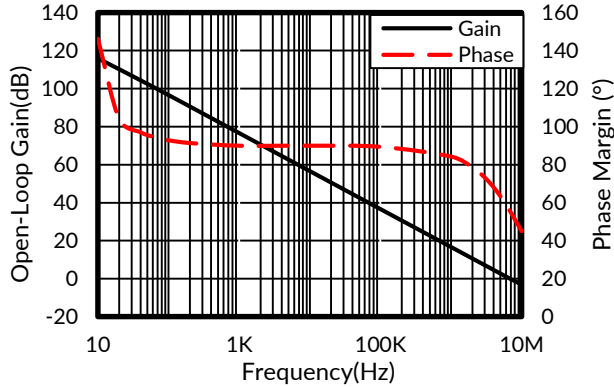

Figure 1. Open-Loop Gain and Phase vs Frequency

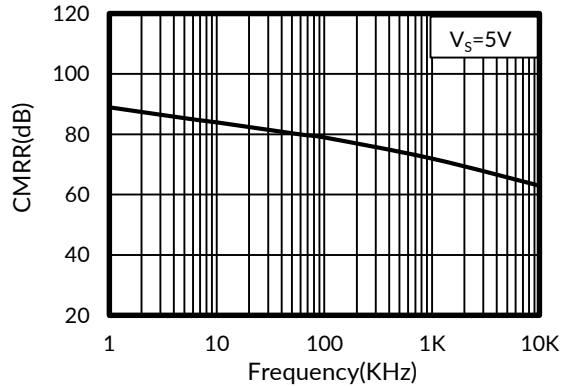

Figure 2. Common-Mode Rejection Ratio vs Frequency

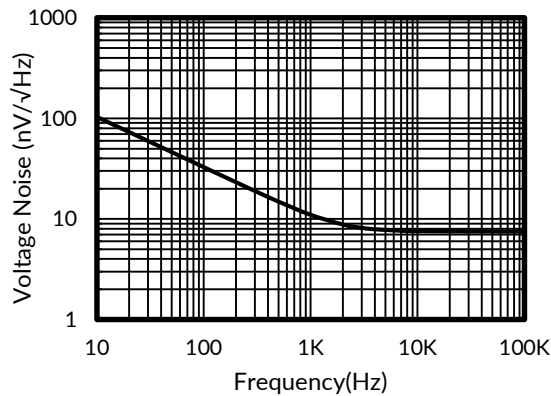

Figure 3. Input Voltage Noise Spectral Density vs Frequency

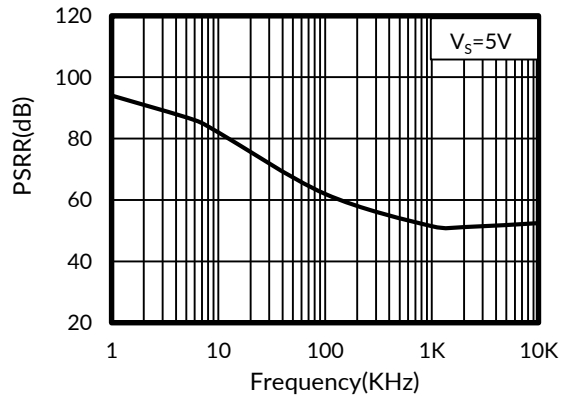

Figure 4. Power-Supply Rejection Ratio vs Frequency

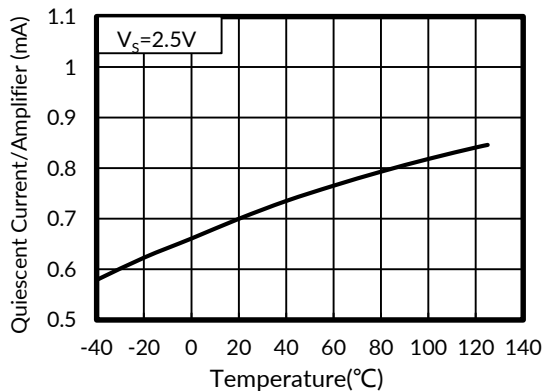

Figure 5. Quiescent Current vs Temperature

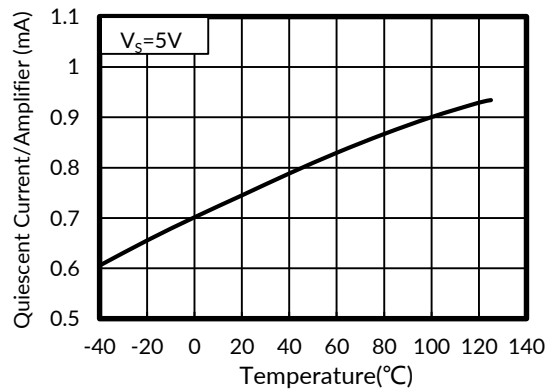

Figure 6. Quiescent Current vs Temperature

TYPICAL CHARACTERISTICS

NOTE: The graphs and tables provided following this note are a statistical summary based on a limited number of samples and are provided for informational purposes only.

At $T_A = +25^\circ\text{C}$, $V_S = 5\text{V}$, $R_L = 10\text{k}\Omega$ connected to $V_S/2$, $V_{OUT} = V_S/2$, unless otherwise noted.

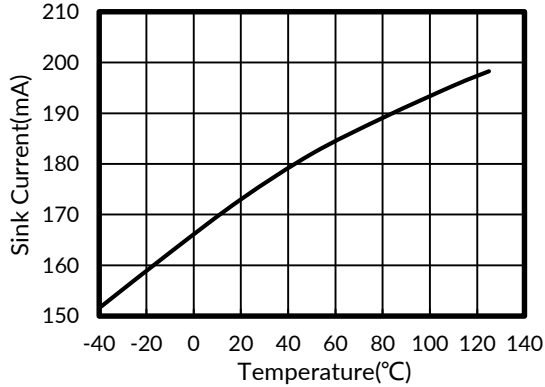

Figure 7. Sink Current vs Temperature

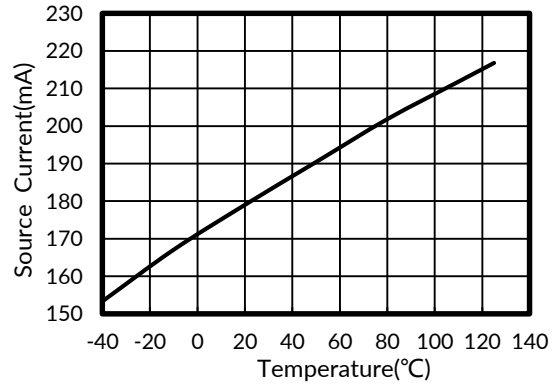

Figure 8. Source Current vs Temperature

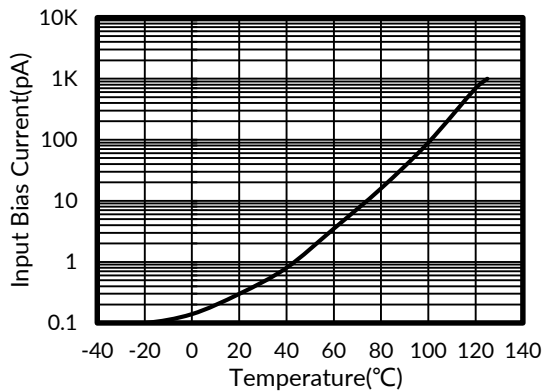

Figure 9. Input Bias Current vs Temperature

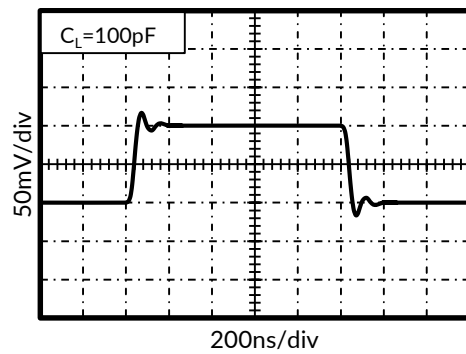

Figure 10. Small-Signal Step Response

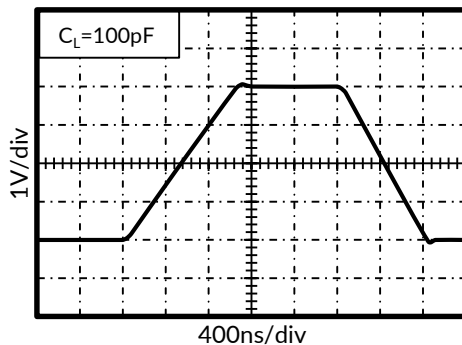

Figure 11. Large-Signal Step Response

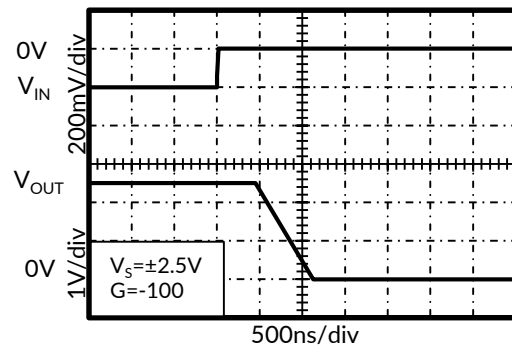

Figure 12. Positive Overtolerance Recovery

TYPICAL CHARACTERISTICS

NOTE: The graphs and tables provided following this note are a statistical summary based on a limited number of samples and are provided for informational purposes only.

At $T_A = +25^\circ\text{C}$, $V_S = 5\text{V}$, $R_L = 10\text{k}\Omega$ connected to $V_S/2$, $V_{OUT} = V_S/2$, unless otherwise noted.

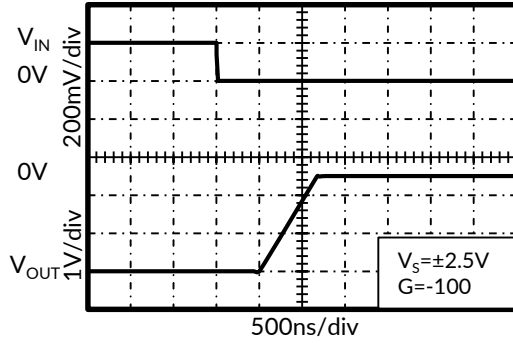

Figure 13. Negative Overvoltage Recovery

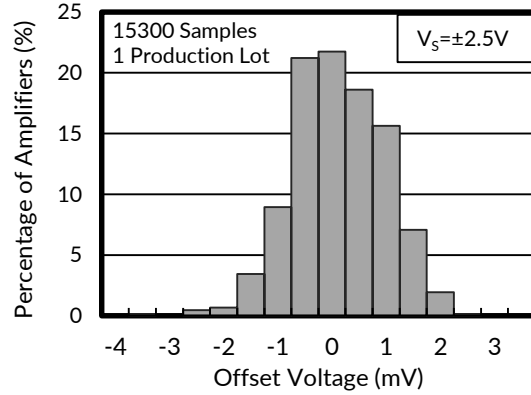

Figure 14. Offset Voltage Production Distribution

8 Application and Implementation

Information in the following applications sections is not part of the Runic component specification, and Runic does not warrant its accuracy or completeness. Runic's customers are responsible for determining suitability of components for their purposes. Customers should validate and test their design implementation to confirm system functionality.

8.1 APPLICATION NOTES

The RS622A are high precision, rail-to-rail operational amplifiers that can be run from a single-supply voltage 2.5V to 5.5V ($\pm 1.25V$ to $\pm 2.75V$). Supply voltages higher than 7V (absolute maximum) can permanently damage the amplifier. Rail-to-rail input and output swing significantly increases dynamic range, especially in low-supply applications. Good layout practice mandates use of a 0.1 μF capacitor placed closely across the supply pins.

8.2 LAYOUT GUIDELINS

Attention to good layout practices is always recommended. Keep traces short. When possible, use a PCB ground plane with surface-mount components placed as close to the device pins as possible. Place a 0.1 μF capacitor closely across the supply pins.

These guidelines should be applied throughout the analog circuit to improve performance and provide benefits such as reducing the EMI susceptibility.

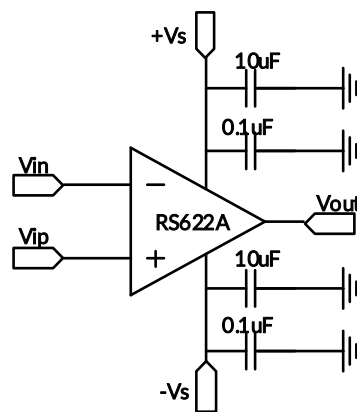

Figure 15. Amplifier with Bypass Capacitors

8.3 INSTRUMENTATION AMPLIFIER

In the three-op amp, instrumentation amplifier configuration shown in Figure 16.

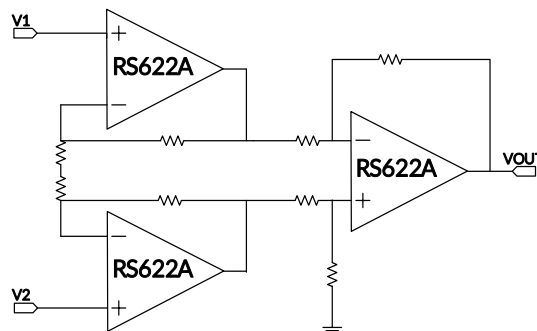
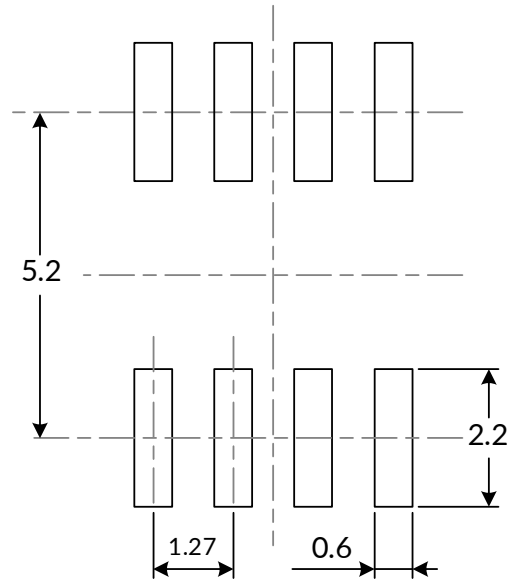
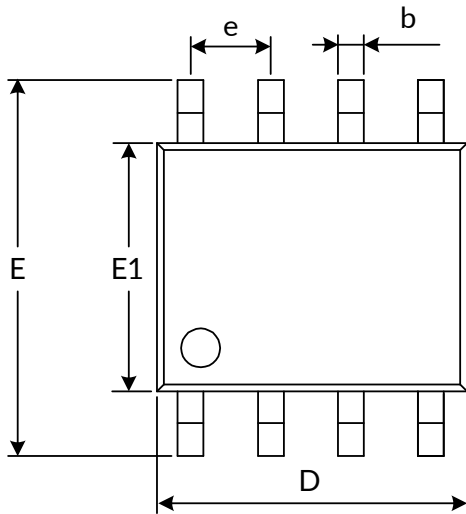

Figure 16. Amplifier instrumentation amplifier

9 PACKAGE OUTLINE DIMENSIONS

SOP8⁽³⁾



RECOMMENDED LAND PATTERN (Unit: mm)

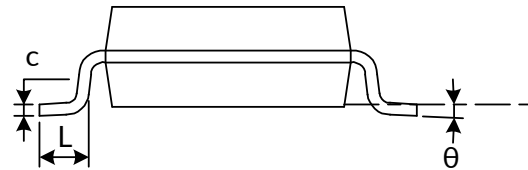
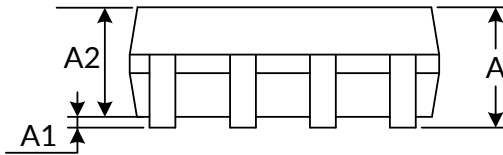

Symbol	Dimensions In Millimeters		Dimensions In Inches	
	Min	Max	Min	Max
A ⁽¹⁾	1.350	1.750	0.053	0.069
A1	0.100	0.250	0.004	0.010
A2	1.350	1.550	0.053	0.061
b	0.330	0.510	0.013	0.020
c	0.170	0.250	0.007	0.010
D ⁽¹⁾	4.800	5.000	0.189	0.197
e	1.270(BSC) ⁽²⁾		0.050(BSC) ⁽²⁾	
E	5.800	6.200	0.228	0.244
E1 ⁽¹⁾	3.800	4.000	0.150	0.157
L	0.400	1.270	0.016	0.050
θ	0°	8°	0°	8°

NOTE:

1. Plastic or metal protrusions of 0.15mm maximum per side are not included.
2. BSC (Basic Spacing between Centers), "Basic" spacing is nominal.
3. This drawing is subject to change without notice.

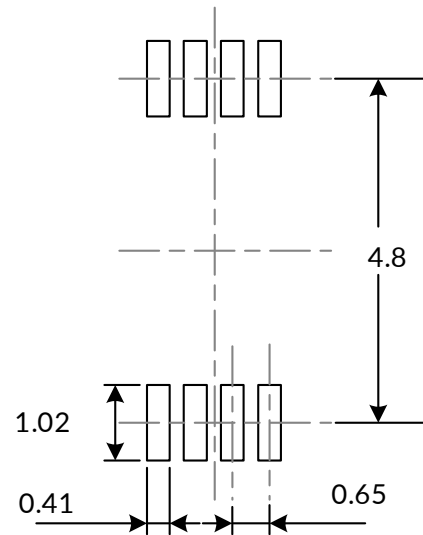
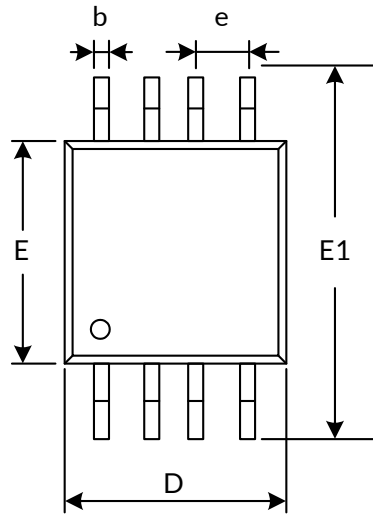
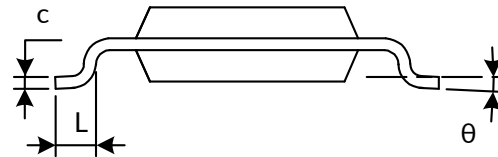
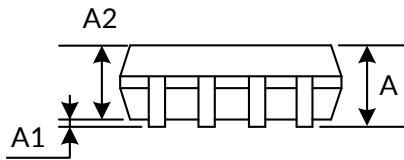
MSOP8⁽³⁾

RECOMMENDED LAND PATTERN (Unit: mm)

Symbol	Dimensions In Millimeters		Dimensions In Inches	
	Min	Max	Min	Max
A ⁽¹⁾	0.820	1.100	0.032	0.043
A1	0.020	0.150	0.001	0.006
A2	0.750	0.950	0.030	0.037
b	0.250	0.380	0.010	0.015
c	0.090	0.230	0.004	0.009
D ⁽¹⁾	2.900	3.100	0.114	0.122
e	0.650(BSC) ⁽²⁾		0.026(BSC) ⁽²⁾	
E ⁽¹⁾	2.900	3.100	0.114	0.122
E1	4.750	5.050	0.187	0.199
L	0.400	0.800	0.016	0.031
θ	0°	6°	0°	6°

NOTE:

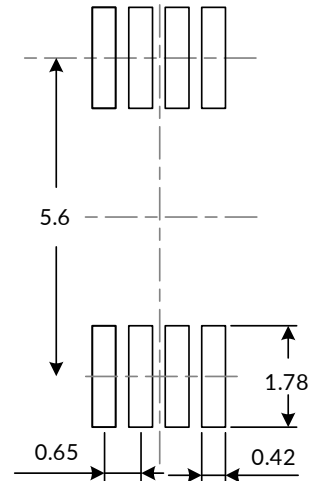
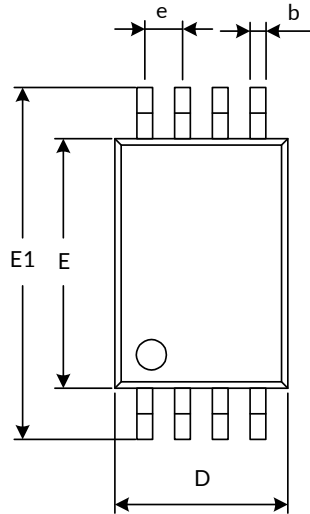
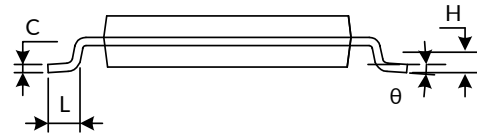
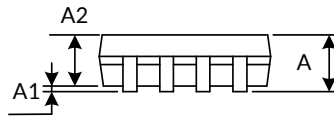
1. Plastic or metal protrusions of 0.15mm maximum per side are not included.
2. BSC (Basic Spacing between Centers), "Basic" spacing is nominal.
3. This drawing is subject to change without notice.

TSSOP8 (3)

RECOMMENDED LAND PATTERN (Unit: mm)

Symbol	Dimensions In Millimeters		Dimensions In Inches	
	Min	Max	Min	Max
A ⁽¹⁾		1.200		0.047
A1	0.050	0.150	0.002	0.006
A2	0.800	1.050	0.031	0.041
b	0.190	0.300	0.007	0.012
c	0.090	0.200	0.004	0.008
D ⁽¹⁾	2.900	3.100	0.114	0.122
E ⁽¹⁾	4.300	4.500	0.169	0.177
E1	6.250	6.550	0.246	0.258
e	0.650(BSC) ⁽²⁾		0.026(BSC) ⁽²⁾	
L	0.500	0.700	0.020	0.028
H	0.25(TYP)		0.01(TYP)	
θ	1°	7°	1°	7°

NOTE:

1. Plastic or metal protrusions of 0.15mm maximum per side are not included.
2. BSC (Basic Spacing between Centers), "Basic" spacing is nominal.
3. This drawing is subject to change without notice.

10 TAPE AND REEL INFORMATION

REEL DIMENSIONS

TAPE DIMENSION

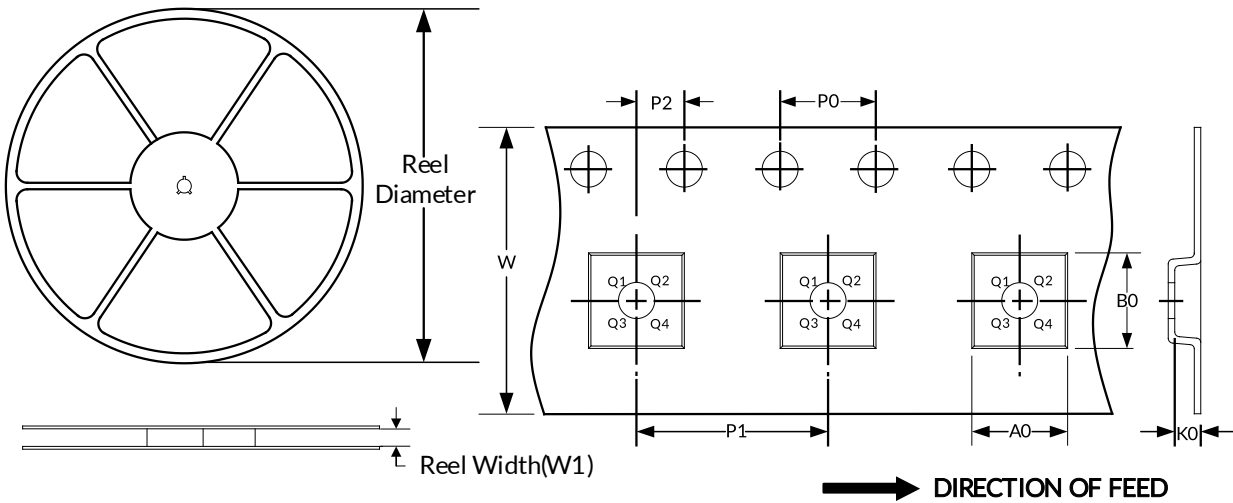

NOTE: The picture is only for reference. Please make the object as the standard.

KEY PARAMETER LIST OF TAPE AND REEL

Package Type	Reel Diameter	Reel Width(mm)	A0 (mm)	B0 (mm)	K0 (mm)	P0 (mm)	P1 (mm)	P2 (mm)	W (mm)	Pin1 Quadrant
SOP8	13"	12.4	6.40	5.40	2.10	4.0	8.0	2.0	12.0	Q1
TSSOP8	13"	12.4	6.90	3.45	1.65	4.0	8.0	2.0	12.0	Q1
MSOP8	13"	12.4	5.20	3.30	1.50	4.0	8.0	2.0	12.0	Q1

NOTE:

1. All dimensions are nominal.
2. Plastic or metal protrusions of 0.15mm maximum per side are not included.

IMPORTANT NOTICE AND DISCLAIMER

Jiangsu Runic Technology Co., Ltd. will accurately and reliably provide technical and reliability data (including data sheets), design resources (including reference designs), application or other design advice, WEB tools, safety information and other resources, without warranty of any defect, and will not make any express or implied warranty, including but not limited to the warranty of merchantability Implied warranty that it is suitable for a specific purpose or does not infringe the intellectual property rights of any third party.

These resources are intended for skilled developers designing with Runic products You will be solely responsible for: (1) Selecting the appropriate products for your application; (2) Designing, validating and testing your application; (3) Ensuring your application meets applicable standards and any other safety, security or other requirements; (4) Runic and the Runic logo are registered trademarks of Runic Incorporated. All trademarks are the property of their respective owners; (5) For change details, review the revision history included in any revised document. The resources are subject to change without notice. Our company will not be liable for the use of this product and the infringement of patents or third-party intellectual property rights due to its use.