

15kHz, 800nA, Rail-to-Rail I/O CMOS Operational Amplifier

FEATURES

- **GAIN BANDWIDTH: 15kHz**
- **RAIL-TO-RAIL INPUT AND OUTPUT**
±0.8mV Typical Vos
- **INPUT VOLTAGE RANGE: -0.1V to +5.6V**
with Vs = 5.5V
- **SUPPLY RANGE: +1.4V to +5.5V**
- **SPECIFIED UP TO +125°C**
- **Micro SIZE PACKAGES: SOT23-5**

APPLICATIONS

- **SENSORS**
- **PHOTODIODE AMPLIFICATION**
- **WEARABLE PRODUCTS**
- **TEMPERATURE MEASUREMENT**
- **BATTERY POWERED SYSTEM**

DESCRIPTION

The RS8031, RS8032, RS8034 families of products offer low voltage operation and rail-to-rail input and output, as well as excellent speed/power consumption ratio, providing an excellent bandwidth (15kHz) and slew rate of 7.5V/ms. The op-amps are unity gain stable and feature an ultra-low input bias current.

The devices are ideal for sensor interfaces, active filters, and portable applications. The RS8031, RS8032, RS8034 families of operational amplifiers are specified at the full temperature range of -40°C to +125°C under single or dual power supplies of 1.4V to 5.5V.

Device Information (1)

PART NUMBER	PACKAGE	BODY SIZE(NOM)
RS8031	SOT23-5	2.90mm×1.60mm
	SOP8	4.90mm×3.90mm
	MSOP8	3.00mm×3.00mm
RS8032	SOP8	4.90mm×3.90mm
	MSOP8	3.00mm×3.00mm
	DFN2X2-8	2.00mm×2.00mm
RS8034	SOP14	8.65mm×3.90mm
	TSSOP14	5.00mm×4.40mm

(1) For all available packages, see the orderable addendum at the end of the data sheet.

Revision History

Note: Page numbers for previous revisions may differ from page numbers in the current version.

Version	Change Date	Change Item
C.1	2022/05/17	<ol style="list-style-type: none">1. Added the TDFN2x2-8L package2. Update Package Qty on Page 2@RevB.53. Update ELECTRICAL CHARACTERISTICS on Page 3@RevB.54. Update ESD Ratings5. Added TAPE AND REEL INFORMATION
C.1.1	2024/03/04	Modify packaging naming

Pin Configuration and Functions (Top View)

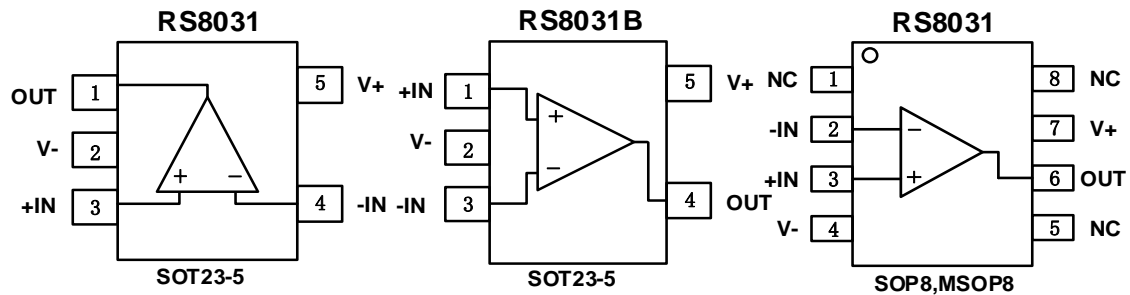

Pin Description

NAME	PIN			I/O	DESCRIPTION
	RS8031	RS8031B	RS8031		
	SOT23-5	SOT23-5	SOP8/MSOP8		
-IN	4	3	2	I	Negative (inverting) input
+IN	3	1	3	I	Positive (noninverting) input
NC	-	-	1,5,8	-	No internal connection (can be left floating)
OUT	1	4	6	O	Output
V-	2	2	4	-	Negative (lowest) power supply
V+	5	5	7	-	Positive (highest) power supply

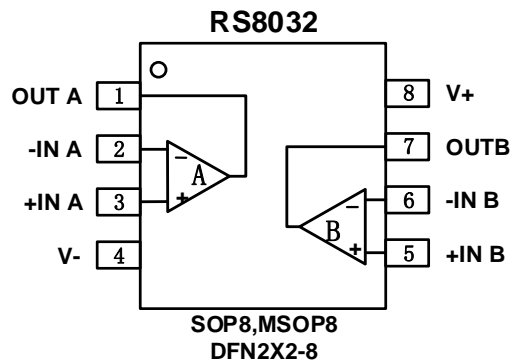

Pin Description

NAME	PIN	I/O	DESCRIPTION
	SOP8/MSOP8/DFN2X2-8		
-INA	2	I	Inverting input, channel A
+INA	3	I	Noninverting input, channel A
-INB	6	I	Inverting input, channel B
+INB	5	I	Noninverting input, channel B
OUTA	1	O	Output, channel A
OUTB	7	O	Output, channel B
V-	4	-	Negative (lowest) power supply
V+	8	-	Positive (highest) power supply

Pin Configuration and Functions (Top View)

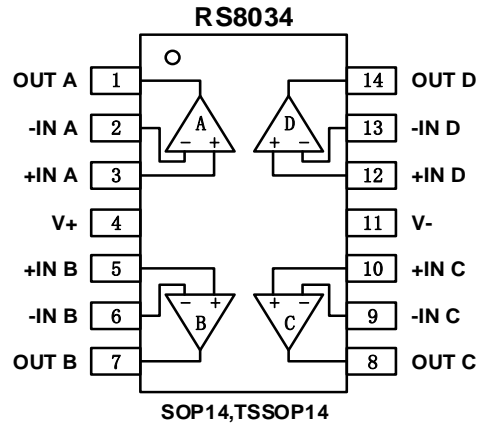

Pin Description

NAME	PIN	I/O	DESCRIPTION
	SOP14/TSSOP14		
-INA	2	I	Inverting input, channel A
+INA	3	I	Noninverting input, channel A
-INB	6	I	Inverting input, channel B
+INB	5	I	Noninverting input, channel B
-INC	9	I	Inverting input, channel C
+INC	10	I	Noninverting input, channel C
-IND	13	I	Inverting input, channel D
+IND	12	I	Noninverting input, channel D
OUTA	1	O	Output, channel A
OUTB	7	O	Output, channel B
OUTC	8	O	Output, channel C
OUTD	14	O	Output, channel D
V-	11	-	Negative (lowest) power supply
V+	4	-	Positive (highest) power supply

SPECIFICATIONS

Absolute Maximum Ratings

Over operating free-air temperature range (unless otherwise noted) ⁽¹⁾

		MIN	MAX	UNIT
Voltage	Supply, $V_S=(V+) - (V-)$		7	V
	Signal input pin ⁽²⁾	(V-)-0.5	(V+) +0.5	
	Signal output pin ⁽³⁾	(V-)-0.5	(V+) +0.5	
Current	Signal input pin ⁽²⁾	-10	10	mA
	Signal output pin ⁽³⁾	-55	55	mA
	Output short-circuit ⁽⁴⁾	Continuous		
Temperature	Operating range, T_A	-40	125	°C
	Junction, T_J	-40	150	
	Storage, T_{stg}	-65	150	

(1) Stresses above these ratings may cause permanent damage. Exposure to absolute maximum conditions for extended periods may degrade device reliability. These are stress ratings only, and functional operation of the device at these or any other conditions beyond those specified is not implied.

(2) Input terminals are diode-clamped to the power-supply rails. Input signals that can swing more than 0.5V beyond the supply rails should be current-limited to 10mA or less.

(3) Output terminals are diode-clamped to the power-supply rails. Output signals that can swing more than 0.5V beyond the supply rails should be current-limited to ± 55 mA or less.

(4) Short-circuit to ground, one amplifier per package.

ESD Ratings

			VALUE	UNIT
$V_{(ESD)}$	Electrostatic discharge	Human-body model (HBM)	± 8000	V
		Charge device model (CDM)	± 500	
		Machine Model (MM)	± 300	

Recommended Operating Conditions

Over operating free-air temperature range (unless otherwise noted)

		MIN	NOM	MAX	UNIT
Supply voltage, $V_S=(V+) - (V-)$	Single-supply	1.4		5.5	V
	Dual-supply	± 0.7		± 2.75	

Thermal Information: RS8031

THERMAL METRIC		RS8031			UNIT
		5PINS	8PINS		
		SOT23-5	SOP8	MSOP8	
$R_{\theta JA}$	Junction-to-ambient thermal resistance	273.8	116	165	°C/W
$R_{\theta JC(top)}$	Junction-to-case(top) thermal resistance	126.8	60	53	°C/W
$R_{\theta JB}$	Junction-to-board thermal resistance	85.9	56	87	°C/W
Ψ_{JT}	Junction-to-top characterization parameter	10.9	12.8	4.9	°C/W
Ψ_{JB}	Junction-to-board characterization parameter	84.9	98.3	85	°C/W
$R_{\theta JC(bot)}$	Junction-to-case(bottom) thermal resistance	N/A	N/A	N/A	°C/W

Thermal Information: RS8032

THERMAL METRIC		RS8032			UNIT
		8PINS			
		SOP8	MSOP8	DFN2X2-8	
$R_{\Theta JA}$	Junction-to-ambient thermal resistance	116	80.1	80.1	°C/W
$R_{\Theta JC(top)}$	Junction-to-case(top) thermal resistance	60	100	100	°C/W
$R_{\Theta JB}$	Junction-to-board thermal resistance	56	45	45	°C/W
Ψ_{JT}	Junction-to-top characterization parameter	12.8	6.8	6.8	°C/W
Ψ_{JB}	Junction-to-board characterization parameter	98.3	45.2	45.2	°C/W
$R_{\Theta JC(bot)}$	Junction-to-case(bottom) thermal resistance	N/A	22.7	22.7	°C/W

Thermal Information: RS8034

THERMAL METRIC		RS8034		UNIT
		14PINS		
		SOP14	TSSOP14	
$R_{\Theta JA}$	Junction-to-ambient thermal resistance	83.8	120.8	°C/W
$R_{\Theta JC(top)}$	Junction-to-case(top) thermal resistance	70.7	34.3	°C/W
$R_{\Theta JB}$	Junction-to-board thermal resistance	59.5	62.8	°C/W
Ψ_{JT}	Junction-to-top characterization parameter	11.6	1	°C/W
Ψ_{JB}	Junction-to-board characterization parameter	37.7	56.5	°C/W
$R_{\Theta JC(bot)}$	Junction-to-case(bottom) thermal resistance	N/A	N/A	°C/W

PACKAGE/ORDERING INFORMATION

Orderable Device	Package Type	Pin	Channel	Op Temp(°C)	Device Marking ⁽¹⁾	Package Qty
RS8031XF	SOT23-5	5	1	-40°C ~125°C	8031	Tape and Reel,3000
RS8031BXF	SOT23-5	5	1	-40°C ~125°C	8031B	Tape and Reel,3000
RS8031XK	SOP8	8	1	-40°C ~125°C	RS8031	Tape and Reel,4000
RS8031XM	MSOP8	8	1	-40°C ~125°C	RS8031	Tape and Reel,4000
RS8032XK	SOP8	8	2	-40°C ~125°C	RS8032	Tape and Reel,4000
RS8032XM	MSOP8	8	2	-40°C ~125°C	RS8032	Tape and Reel,4000
RS8032XTDE8	DFN2X2-8	8	2	-40°C ~125°C	8032	Tape and Reel,3000
RS8034XP	SOP14	14	4	-40°C ~125°C	RS8034	Tape and Reel,4000
RS8034XQ	TSSOP14	14	4	-40°C ~125°C	RS8034	Tape and Reel,4000

NOTE:

- (1) There may be additional marking, which relates to the lot trace code information (data code and vendor code), the logo or the environmental category on the device.

ELECTRICAL CHARACTERISTICS

(At $T_A = +25^\circ\text{C}$, $V_S = 5.0\text{V}$, $R_L = 1\text{M}\Omega$ connected to $V_S/2$, and $V_{OUT} = V_S/2$, unless otherwise noted.)

PARAMETER		CONDITIONS	RS8031, RS8032, RS8034			
			MIN	TYP	MAX	UINT
POWER SUPPLY						
V_S	Operating Voltage Range		1.4		5.5	V
I_Q	Quiescent Current/Amplifier			800	1500	nA
PSRR	Power-Supply Rejection Ratio	$V_S = 2.5\text{V to } 5.5\text{V}$, $V_{CM} = (V_-) + 0.5\text{V}$	62	70		dB
INPUT						
V_{OS}	Input Offset Voltage	$V_{CM} = V_S/2$	-4	± 0.8	4	mV
$V_{OS\ Tc}$	Input Offset Voltage Average Drift	$V_{CM} = V_S/2$, $T_A = -40^\circ\text{C to } 125^\circ\text{C}$		± 2.3		$\mu\text{V}/^\circ\text{C}$
I_B	Input Bias Current		-10	± 1	10	pA
I_{OS}	Input Offset Current		-10	± 1	10	pA
V_{CM}	Common-Mode Voltage Range	$V_S = 5.5\text{V}$	-0.1		5.6	V
CMRR	Common-Mode Rejection Ratio	$V_S = 5.5\text{V}$, $V_{CM} = -0.1\text{V to } 4\text{V}$	73	90		dB
		$V_S = 5.5\text{V}$, $V_{CM} = -0.1\text{V to } 5.6\text{V}$	60	83		dB
OUTPUT						
A_{OL}	Open-Loop Voltage Gain	$V_S = 1.4\text{V}$, $R_L = 50\text{k}\Omega$, $V_O = V_S - 0.1\text{V}$	85	102		dB
		$V_S = 5.0\text{V}$, $R_L = 50\text{k}\Omega$, $V_O = V_S - 0.1\text{V}$	92	106		dB
	Output Swing From Rail	$R_L = 50\text{k}\Omega$		5		mV
I_{OUT}	Output Short-Circuit Current			30		mA
FREQUENCY RESPONSE						
SR	Slew Rate			7.5		V/ms
GBP	Gain-Bandwidth Product			15		kHz
PM	Phase Margin			60		$^\circ$
NOISE						
$e_{n\text{-p-p}}$	Input Voltage Noise	$f = 0.1\text{ Hz to } 10\text{ Hz}$		2.4		μVpp
e_n	Input Voltage Noise Density	$f = 1\text{ kHz}$		160		$\text{nV}/\sqrt{\text{Hz}}$

TYPICAL CHARACTERISTICS

At $T_A = +25^\circ\text{C}$, $V_S=5\text{V}$, $R_L = 1\text{M}\Omega$ connected to $V_S/2$, $C_L=60\text{pF}$ $V_{CM} = V_S/2$, unless otherwise noted.

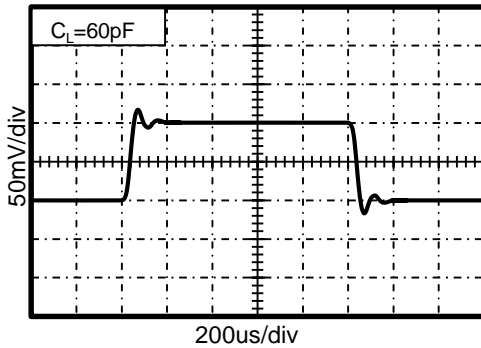

Figure 1. Small-Signal Step Response

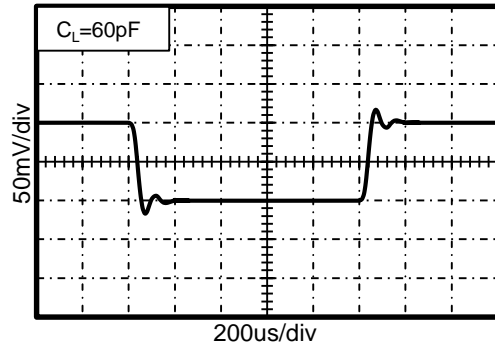

Figure 2. Small-Signal Step Response

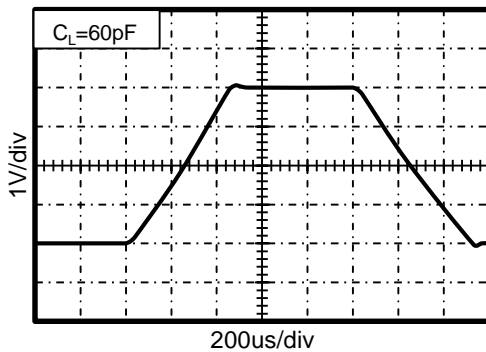

Figure 3. Large-Signal Step Response

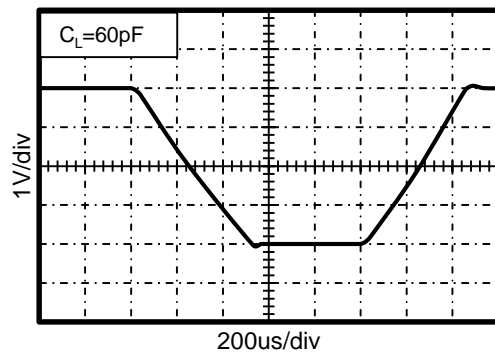

Figure 4. Large-Signal Step Response

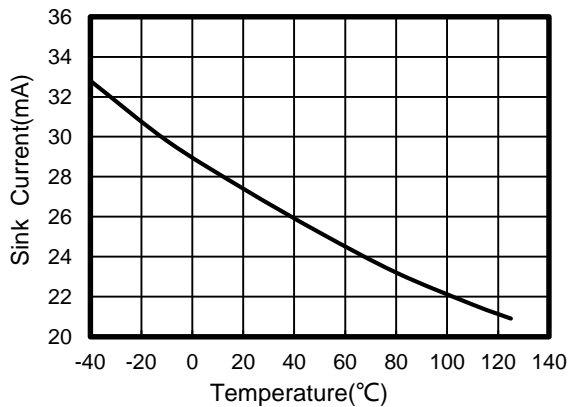

Figure 5. Sink Current vs Temperature

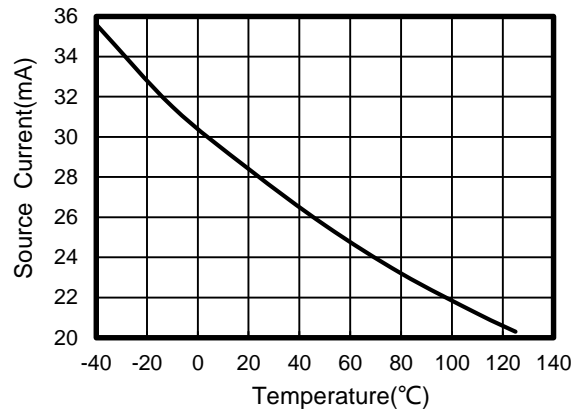
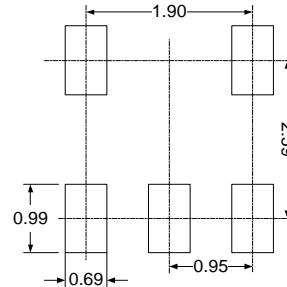
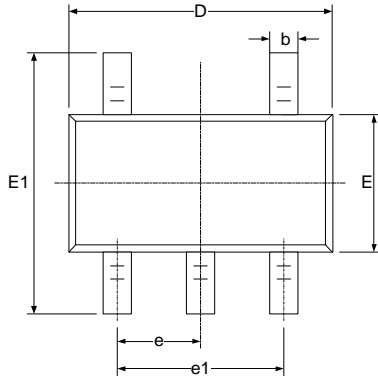
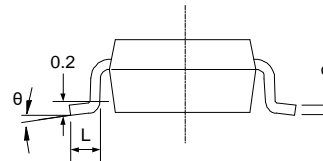
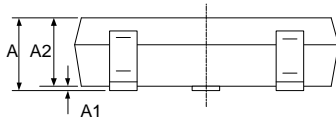
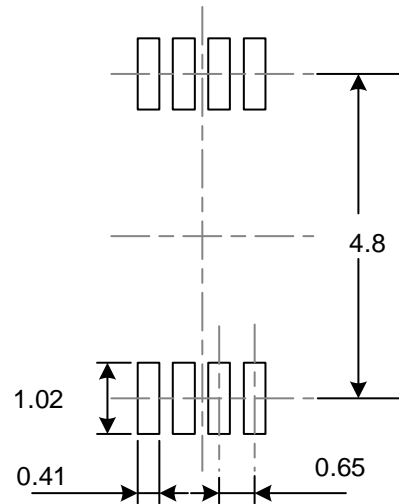
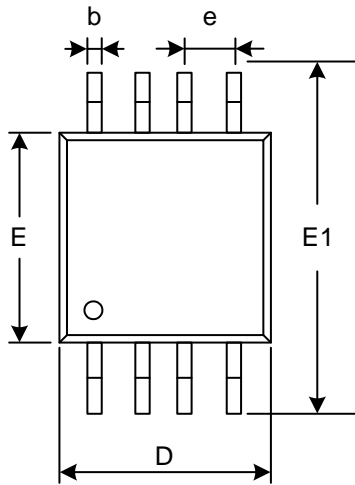
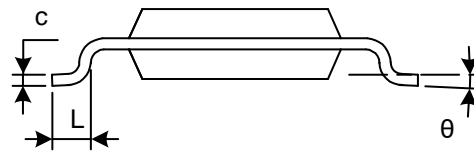
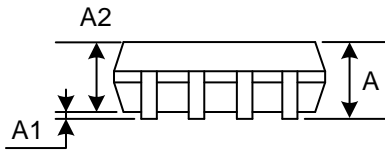

Figure 6. Source Current vs Temperature

PACKAGE OUTLINE DIMENSIONS
SOT23-5

RECOMMENDED LAND PATTERN (Unit: mm)

Symbol	Dimensions In Millimeters		Dimensions In Inches	
	Min	Max	Min	Max
A	1.050	1.250	0.041	0.049
A1	0.000	0.100	0.000	0.004
A2	1.050	1.150	0.041	0.045
b	0.300	0.500	0.012	0.020
c	0.100	0.200	0.004	0.008
D	2.820	3.020	0.111	0.119
E	1.500	1.700	0.059	0.067
E1	2.650	2.950	0.104	0.116
e	0.950(BSC)		0.037(BSC)	
e1	1.800	2.000	0.071	0.079
L	0.300	0.600	0.012	0.024
θ	0°	8°	0°	8°

MSOP8

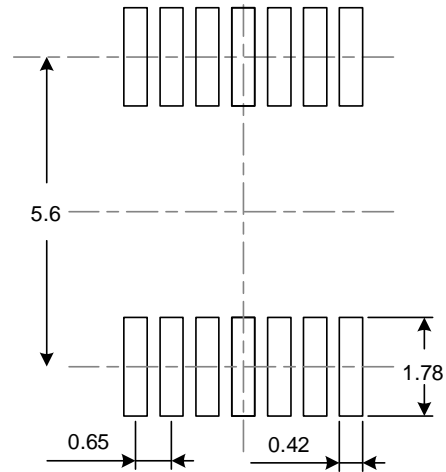
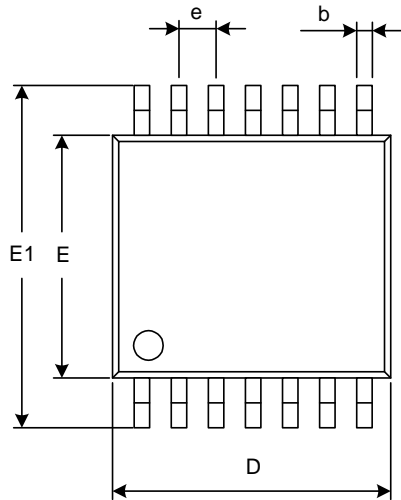
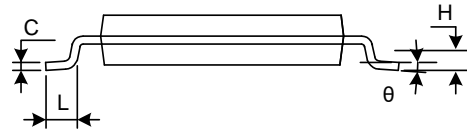
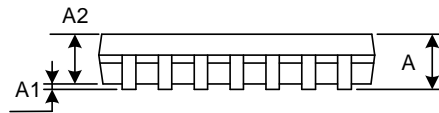
RECOMMENDED LAND PATTERN (Unit: mm)

Symbol	Dimensions In Millimeters		Dimensions In Inches	
	Min	Max	Min	Max
A	0.820	1.100	0.032	0.043
A1	0.020	0.150	0.001	0.006
A2	0.750	0.950	0.030	0.037
b	0.250	0.380	0.010	0.015
c	0.090	0.230	0.004	0.009
D	2.900	3.100	0.114	0.122
e	0.650(BSC)		0.026(BSC)	
E	2.900	3.100	0.114	0.122
E1	4.750	5.050	0.187	0.199
L	0.400	0.800	0.016	0.031
θ	0°	6°	0°	6°

TSSOP14

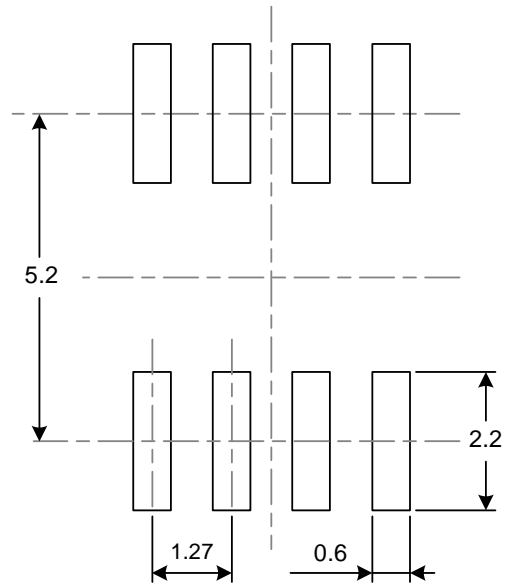
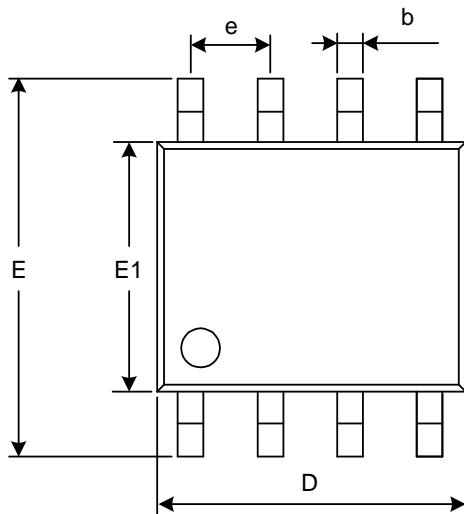
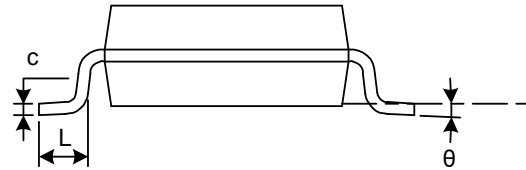
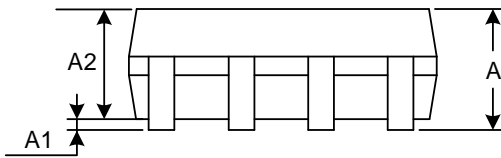
RECOMMENDED LAND PATTERN (Unit: mm)

Symbol	Dimensions In Millimeters		Dimensions In Inches	
	Min	Max	Min	Max
A		1.200		0.047
A1	0.050	0.150	0.002	0.006
A2	0.800	1.050	0.031	0.041
b	0.190	0.300	0.007	0.012
c	0.090	0.200	0.004	0.008
D	4.860	5.100	0.191	0.201
E	4.300	4.500	0.169	0.177
E1	6.250	6.550	0.246	0.258
e	0.650(BSC)		0.026(BSC)	
L	0.500	0.700	0.020	0.028
H	0.25(TYP)		0.01(TYP)	
θ	1°	7°	1°	7°

SOP8

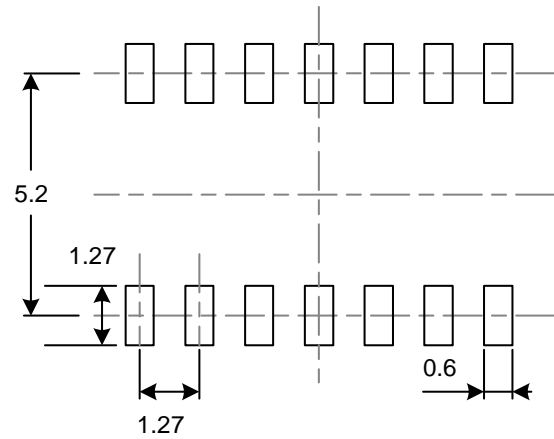
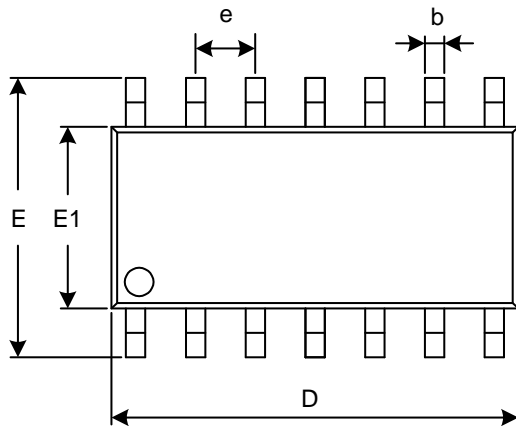
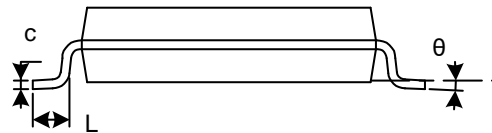
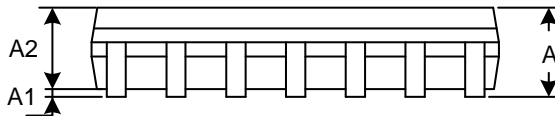
RECOMMENDED LAND PATTERN (Unit: mm)

Symbol	Dimensions In Millimeters		Dimensions In Inches	
	Min	Max	Min	Max
A	1.350	1.750	0.053	0.069
A1	0.100	0.250	0.004	0.010
A2	1.350	1.550	0.053	0.061
b	0.330	0.510	0.013	0.020
c	0.170	0.250	0.007	0.010
D	4.800	5.000	0.189	0.197
e	1.270(BSC)		0.050(BSC)	
E	5.800	6.200	0.228	0.244
E1	3.800	4.000	0.150	0.157
L	0.400	1.270	0.016	0.050
θ	0°	8°	0°	8°

SOP14

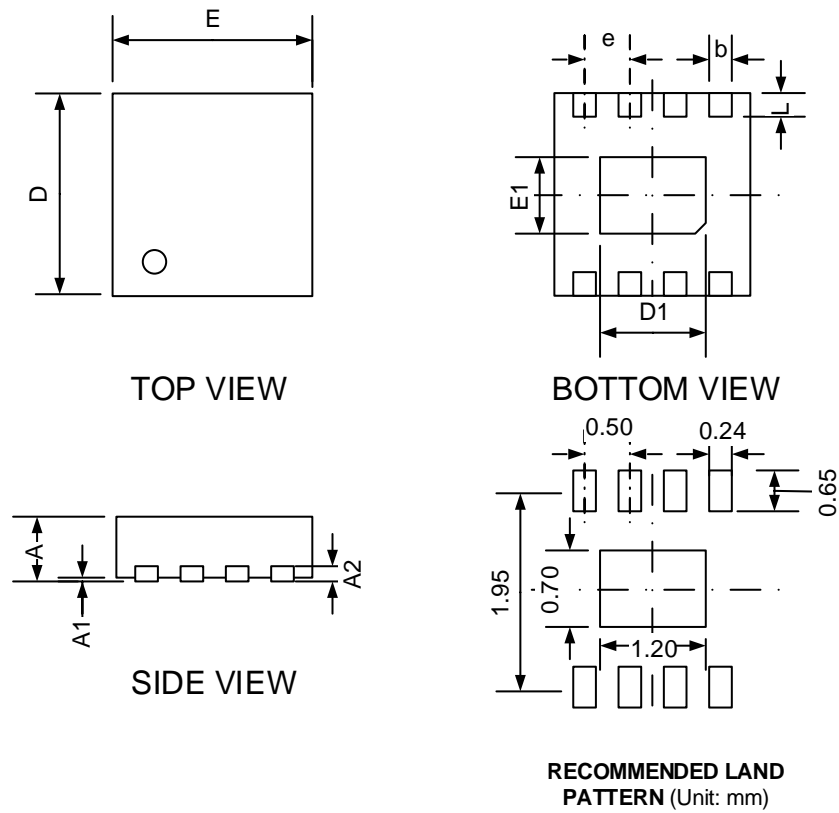
RECOMMENDED LAND PATTERN (Unit: mm)

Symbol	Dimensions In Millimeters		Dimensions In Inches	
	Min	Max	Min	Max
A	1.350	1.750	0.053	0.069
A1	0.100	0.250	0.004	0.010
A2	1.350	1.550	0.053	0.061
b	0.310	0.510	0.012	0.020
c	0.100	0.250	0.004	0.010
D	8.450	8.850	0.333	0.348
e	1.270(BSC)		0.050(BSC)	
E	5.800	6.200	0.228	0.244
E1	3.800	4.000	0.150	0.157
L	0.400	1.270	0.016	0.050
θ	0°	8°	0°	8°

DFN2X2-8

Symbol	Dimensions In Millimeters		Dimensions In Inches	
	Min	Max	Min	Max
A	0.700	0.800	0.028	0.031
A1	0.000	0.050	0.000	0.002
A2	0.203(TYP)		0.008(TYP)	
b	0.180	0.300	0.007	0.012
D	1.900	2.100	0.075	0.083
D1	1.100	1.300	0.043	0.051
E	1.900	2.100	0.075	0.083
E1	0.600	0.800	0.024	0.031
e	0.500(TYP)		0.020(TYP)	
L	0.250	0.450	0.010	0.018

TAPE AND REEL INFORMATION
REEL DIMENSIONS

TAPE DIMENSION

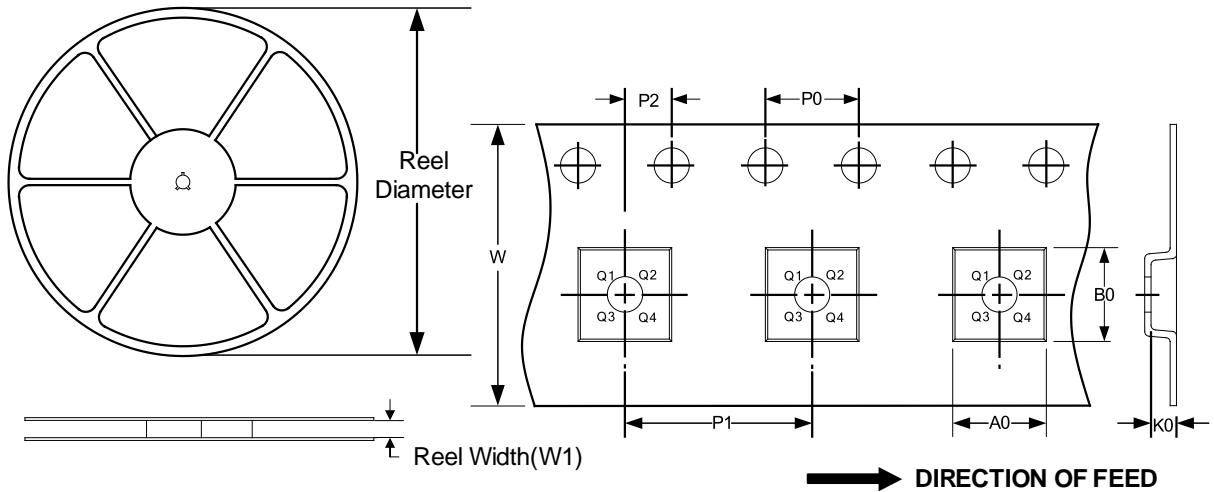

NOTE: The picture is only for reference. Please make the object as the standard.

KEY PARAMETER LIST OF TAPE AND REEL

Package Type	Reel Diameter	Reel Width (mm)	A0 (mm)	B0 (mm)	K0 (mm)	P0 (mm)	P1 (mm)	P2 (mm)	W (mm)	Pin1 Quadrant
SOT23-5	7"	9.5	3.20	3.20	1.40	4.0	4.0	2.0	8.0	Q3
MSOP8	13"	12.4	5.20	3.30	1.50	4.0	8.0	2.0	12.0	Q1
TSSOP14	13"	12.4	6.95	5.60	1.20	4.0	8.0	2.0	12.0	Q1
SOP8	13"	12.4	6.40	5.40	2.10	4.0	8.0	2.0	12.0	Q1
SOP14	13"	16.4	6.60	9.30	2.10	4.0	8.0	2.0	16.0	Q1
DFN2X2-8	7"	9.5	2.30	2.30	1.10	4.0	4.0	2.0	8.0	Q2