

Precision Adjustable Current Limited Power Distribution Switches

1 FEATURES

- Up to 3A Maximum Load Current
- Typical 100µA Low Quiescent Current
- Typical 0.1µA Shutdown Current
- No Reversed Leakage Current When Power Off
- Meets USB Current Limiting Requirements
- Adjustable Current Limit: 500mA to 3A
- Fast Over-Current Response: 2µs
- 50mΩ High-side MOSFET
- Reverse Input-Output Voltage Protection
- Under Voltage Lockout
- Thermal Shutdown Protection
- Operating Range: 2.5V to 5.5V
- Built-In Soft-Start Function
- Available in the Green DFN3x3-8L Package

2 APPLICATIONS

- USB Host and Self-Powered Bubs
- USB Bus-Powered Hubs
- USB Power Management
- General Purpose Power Switch (High Side)
- Hot Plug-in Power Supplies
- Battery-Charger Circuits

3 DESCRIPTION

The RS2599 is an integrated power switch for self-powered and bus-powered Universal Serial Bus (USB) applications.

The RS2599 is a cost-effective, low voltage, single P-channel MOSFET load switch with 50mΩ $R_{DS(ON)}$, which is free of parasitic body diode to eliminate any reversed current flow across the switch when it is powered off. When the output voltage is higher than input voltage, the power switch is turned off by internal output reverse-voltage protector.

Several Protection features include current limiting and thermal shutdown to prevent catastrophic switch failure caused by increasing power dissipation when continuous heavy loads or short circuit occurs.

FLAG is an open-drain output report over-current or over-temperature event and has typical 13ms deglitch timeout period. In addition, FLAG also reports output reverse-voltage condition with typical 5ms deglitch timeout period.

RS2599 is available in the Green DFN3x3-8L package. It is rated over the -40°C to +85°C temperature range.

Device Information ⁽¹⁾

PART NUMBER	PACKAGE	BODY SIZE (NOM)
RS2599	DFN3x3-8L	3.00mm×3.00mm

(1) For all available packages, see the orderable addendum at the end of the data sheet.

4 Functional Block Diagram

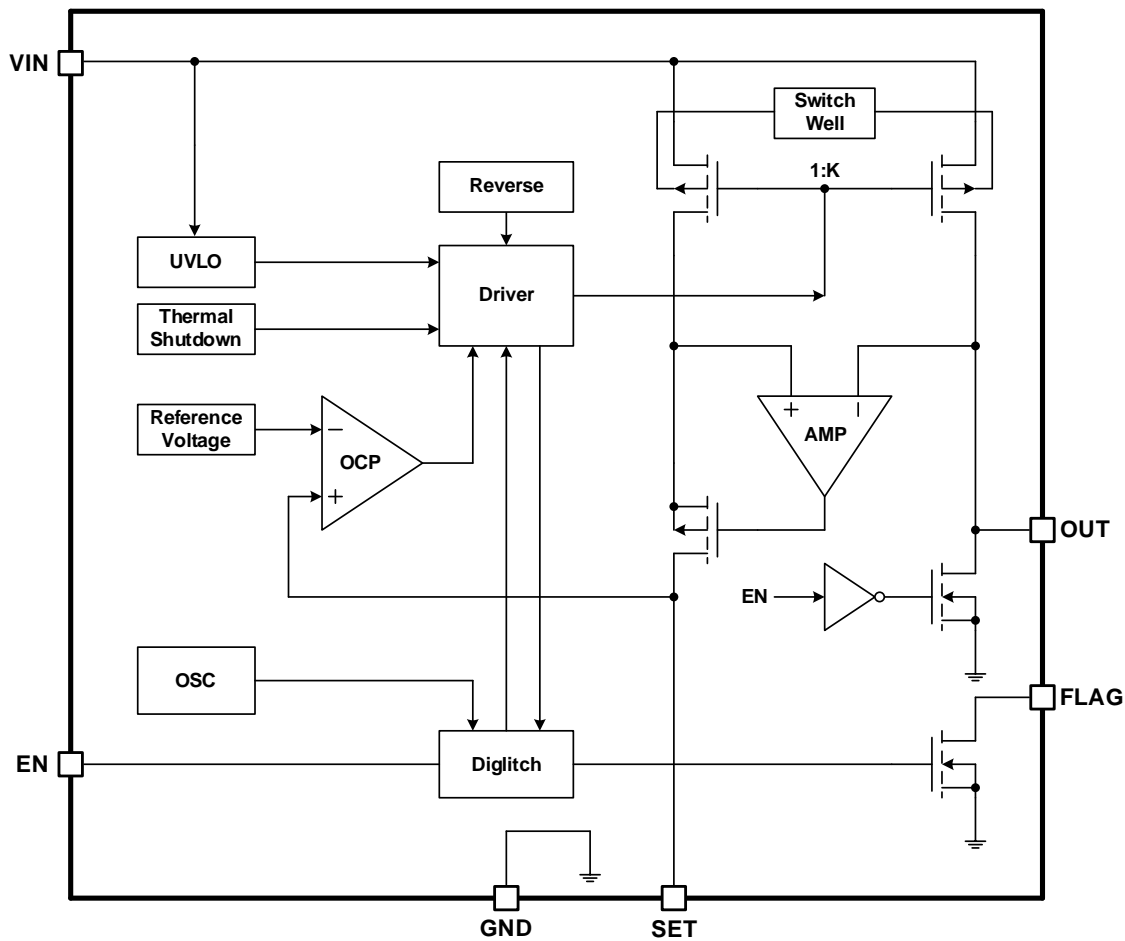

Table of Contents

1 FEATURES	1
2 APPLICATIONS	1
3 DESCRIPTION	1
4 Functional Block Diagram	2
5 Revision History	4
6 PACKAGE/ORDERING INFORMATION	5
7 PIN CONFIGURATIONS	6
8 Specifications	7
8.1 Absolute Maximum Ratings ⁽¹⁾	7
8.2 ESD Ratings.....	7
8.3 Recommended Operating Rating	7
8.4 Thermal Information.....	8
8.5 ELECTRICAL CHARACTERISTICS.....	9
8.6 PARAMETER MEASUREMENT INFORMATION	10
8.7 TYPICAL PERFORMANCE CHARACTERISTICS.....	11
9 DETAILED DESCRIPTION	13
9.1 Input and Output	13
9.2 Thermal Shutdown.....	13
9.3 Soft-Start.....	13
9.4 Under-Voltage Lockout (UVLO).....	13
9.5 Current Limiting and Short-Circuit Protection	13
9.6 Reverse-Voltage Protection	13
9.7 Fault Flag (FLAG)	13
9.8 Power Dissipation	13
9.9 Supply Filter Capacitor.....	14
9.10 Output Filter Capacitor.....	14
9.11 PCB Layout Guide	14
10 PACKAGE OUTLINE DIMENSIONS	15
11 TAPE AND REEL INFORMATION	16

5 Revision History

Note: Page numbers for previous revisions may differ from page numbers in the current version.

VERSION	Change Date	Change Item
A.0	2021/11/26	Initial version completed
A.1	2022/05/05	Official version completed
A.2	2022/08/29	1. Update I_{LIMIT} , I_{SHORT} PARAMETER on Page 8@RevA.1 2. Update Current Limiting and Short-Circuit Protection on Page 12@RevA.1

6 PACKAGE/ORDERING INFORMATION ⁽¹⁾

PRODUCT	ORDERING NUMBER	TEMPERATURE RANGE	PACKAGE LEAD	PACKAGE MARKING ⁽²⁾	PACKAGE OPTION
RS2599	RS2599YTDC8	-40°C ~+85°C	DFN3x3-8L	RS2599	Tape and Reel,5000

NOTE:

- (1) This information is the most current data available for the designated devices. This data is subject to change without notice and revision of this document. For browser-based versions of this data sheet, refer to the right-hand navigation.
- (2) There may be additional marking, which relates to the lot trace code information(data code and vendor code), the logo or the environmental category on the device.

7 PIN CONFIGURATIONS

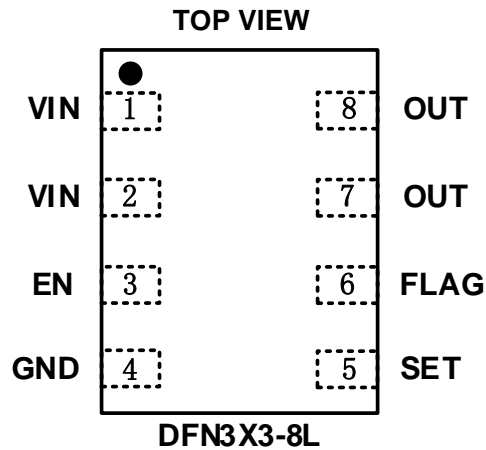

PIN DESCRIPTION

PIN	NAME	DESCRIPTION
1	VIN	Power Supply Input. The P-Channel Source of Switch, Which also supplies IC's internal circuitry. Connect to Positive Supply.
2		
3	EN	Enable Input. Logic Level Enable Input, Active high available.
4	GND	Ground.
5	SET	Current limit set pin. Connect a resistor between this pin and ground to program the desired current limit set point.
6	FLAG	Fault Flag. Active low, open-drain output. Indicates over-current or thermal shutdown conditions. Over-current condition must last longer than t_d in order to assert FLAG
7	OUT	Switch Output. The P-Channel Drain of Switch, Which Typically Connects to Load.
8		

8 Specifications

8.1 Absolute Maximum Ratings ⁽¹⁾

over operating free-air temperature range (unless otherwise noted) ⁽¹⁾

		MIN	MAX	UNIT
V _{IN}	Supply voltage range	-0.3	6.0	V
V _{OUT}	Output voltage range	-0.3	6.0	V
V _{EN}	EN Input Voltage	-0.3	6.0	V
V _{FLAG}	FLAG Output Voltage	-0.3	6.0	V
V _{SET}	SET Output Voltage	-0.3	6.0	V
T _J	Junction temperature ⁽²⁾	-40	150	°C
T _{stg}	Storage temperature	-65	150	°C
T _L	Lead Temperature (Soldering, 10secs)		260	°C

- (1) Stresses beyond those listed under *Absolute Maximum Ratings* may cause permanent damage to the device. These are stress ratings only, and functional operation of the device at these or any other conditions beyond those indicated under *Recommended Operating Conditions* is not implied. Exposure to absolute-maximum-rated conditions for extended periods may affect device reliability.
- (2) The maximum power dissipation is a function of T_{J(MAX)}, R_{θJA}, and T_A. The maximum allowable power dissipation at any ambient temperature is P_D = (T_{J(MAX)} - T_A) / R_{θJA}. All numbers apply for packages soldered directly onto a PCB.

8.2 ESD Ratings

The following ESD information is provided for handling of ESD-sensitive devices in an ESD protected area only.

		VALUE	UNIT
V _(ESD) Electrostatic discharge	Human-body model (HBM), per ANSI/ESDA/JEDEC JS-001 ⁽¹⁾	±6000	V
	Charged-device model (CDM), per ANSI/ESDA/JEDEC JS-002 ⁽²⁾	±1000	

- (1) JEDEC document JEP155 states that 500 V HBM allows safe manufacturing with a standard ESD control process.
- (2) JEDEC document JEP157 states that 250 V CDM allows safe manufacturing with a standard ESD control process.



ESD SENSITIVITY CAUTION

ESD damage can range from subtle performance degradation to complete device failure. Precision integrated circuits may be more susceptible to damage because very small parametric changes could cause the device not to meet its published specifications.

8.3 Recommended Operating Rating

		MIN	MAX	UNIT
V _{IN}	Supply voltage range	2.5	5.5	V
V _{OUT}	Output voltage range	0	5.5	V
V _{EN}	EN Input Voltage	0	5.5	V
V _{FLAG}	FLAG Output Voltage	0	5.5	V
V _{SET}	SET Output Voltage	0	5.5	V
T _A	Operating Temperature	-40	85	°C

8.4 Thermal Information

THERMAL METRIC ⁽¹⁾		RS2599	UNIT
		8PINS	
		DFN3x3-8L	
$R_{\Theta JA}$	Junction-to-ambient thermal resistance	66.9	°C/W
$R_{\Theta JC(top)}$	Junction-to-case(top) thermal resistance	54.5	°C/W
$R_{\Theta JB}$	Junction-to-board thermal resistance	40.4	°C/W
Ψ_{JT}	Junction-to-top characterization parameter	1.9	°C/W
Ψ_{JB}	Junction-to-board characterization parameter	40.4	°C/W
$R_{\Theta JC(bot)}$	Junction-to-case(bottom) thermal resistance	10.8	°C/W

(1) Thermal resistance varies with operating conditions.

8.5 ELECTRICAL CHARACTERISTICS

($V_{IN}=5.0V$, $T_A = +25^{\circ}C$, unless otherwise noted.) ⁽¹⁾

PARAMETER	SYMBOL	TEST CONDITIONS	MIN ⁽²⁾	TYP ⁽³⁾	MAX ⁽²⁾	UNIT
Power Input Voltage Range	V_{IN}		2.5		5.5	V
Power Supply Current	I_Q	Switch on, $V_{OUT}=\text{Open}$		100	200	μA
Shutdown Supply Current	I_{SD}	Switch off, $V_{OUT}=\text{Open}$		0.1	1.0	μA
Under-Voltage Lockout Threshold	V_{UVLO}	$C_{IN}=10\mu F$		1.9	2.4	V
Under-Voltage Lockout Threshold Hysteresis	V_{UVLO_HY}	$C_{IN}=10\mu F$		0.1	0.2	V
High-side MOSFET On Resistance	$R_{DS(ON)}$	$I_{OUT}=500mA$		50	60	$m\Omega$
Enable Input Threshold	V_{IH}	$V_{IN}=2.5V$ to $5.5V$, $C_{IN}=10\mu F$	1.6			V
	V_{IL}	$V_{IN}=2.5V$ to $5.5V$, $C_{IN}=10\mu F$			0.4	V
Enable Input Current	I_{EN}	$V_{EN}=5V$		10	20	μA
Output Turn-On Delay Time	t_{ON}	$C_{IN}=10\mu F$, $R_L=10\Omega$, $C_L=1\mu F$		2.0	3.0	ms
Output Turn-Off Delay Time	t_{OFF}	$C_{IN}=10\mu F$, $R_L=10\Omega$, $C_L=1\mu F$		20	30	μs
Response Time to Short Circuit	t_{SCR}	$C_{IN}=470\mu F$ to $1000\mu F$		2.0		μs
Current Limit Threshold	I_{LIMIT}	$C_{IN}=10\mu F$, $C_L=1\mu F$, $R_{SET}=22k\Omega$	0.44	0.56	0.67	A
		$C_{IN}=10\mu F$, $C_L=1\mu F$, $R_{SET}=12.3k\Omega$	0.80	1.0	1.20	
		$C_{IN}=10\mu F$, $C_L=1\mu F$, $R_{SET}=4.12k\Omega$	2.40	3.0	3.60	
Short-Circuit Current Threshold	I_{SHORT}	$C_{IN}=10\mu F$, $C_L=1\mu F$, $R_{SET}=22k\Omega$	0.33	0.42	0.51	A
		$C_{IN}=10\mu F$, $C_L=1\mu F$, $R_{SET}=12.3k\Omega$	0.60	0.75	0.90	
		$C_{IN}=10\mu F$, $C_L=1\mu F$, $R_{SET}=4.12k\Omega$	1.80	2.25	2.70	
Over-Current FLAG Response Delay Time	t_D	$C_{IN}=10\mu F$, $C_L=1\mu F$, $V_{OUT}=0$ until FLAG is low		13	20	ms
FLAG Output Low Voltage	V_{FLAG_L}	$C_{IN}=10\mu F$, $I_{SINK}=2mA$			200	mV
FLAG Output Leakage Current	I_{FLAG_L}	$C_{IN}=10\mu F$, $V_{FLAG}=5.0V$		0.1	1.0	μA
Discharge Resistor	$R_{Discharge}$	$C_{IN}=10\mu F$, Switch off		300	350	Ω
Thermal Shutdown Temperature	T_{SD}	$C_{IN}=10\mu F$		150		$^{\circ}C$
Thermal Shutdown Hysteresis	T_{SD_HY}	$C_{IN}=10\mu F$		20		$^{\circ}C$

(1) Electrical table values apply only for factory testing conditions at the temperature indicated. Factory testing conditions result in very limited self-heating of the device.

(2) Limits are 100% production tested at $25^{\circ}C$. Limits over the operating temperature range are ensured through correlations using statistical quality control (SQC) method.

(3) Typical values represent the most likely parametric norm as determined at the time of characterization. Actual typical values may vary over time and will also depend on the application and configuration.

8.6 PARAMETER MEASUREMENT INFORMATION

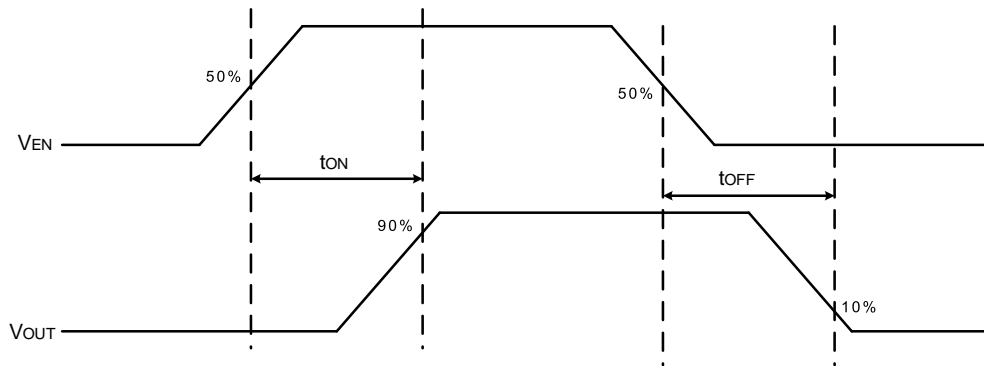

Figure 1. Switch Turn-On and Turn-Off Delay Time

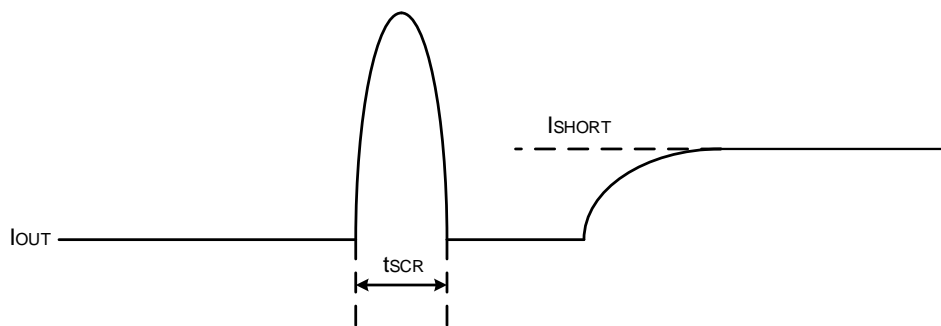

Figure 2. Short-Circuit Response Time

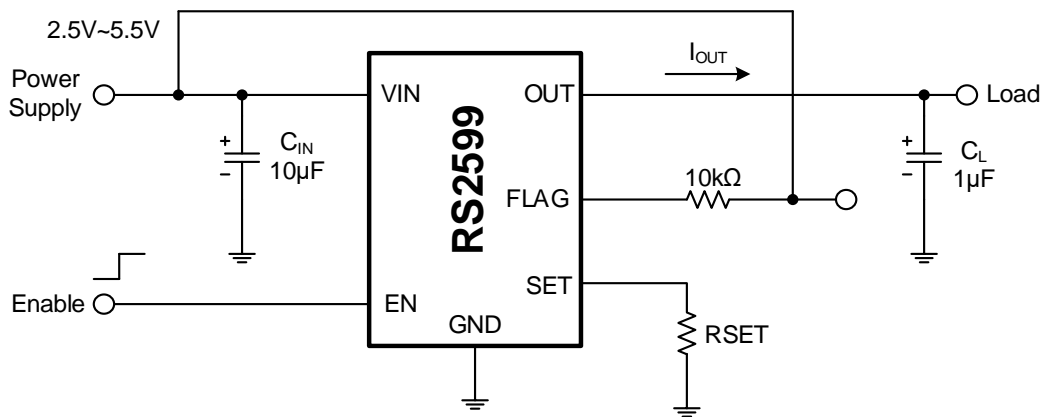

Figure 3. Typical Application Circuit

8.7 TYPICAL PERFORMANCE CHARACTERISTICS

NOTE: The graphs and tables provided following this note are a statistical summary based on a limited number of samples and are provided for informational purposes only.

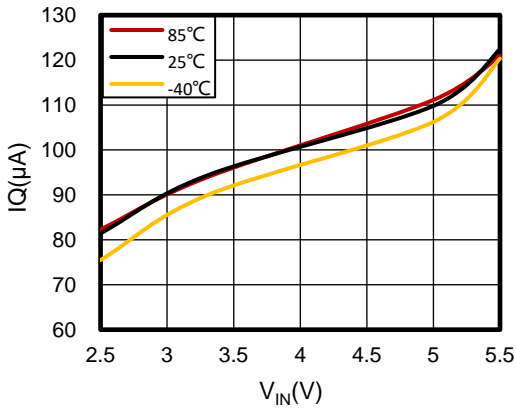

Figure 4. Quiescent Current vs Supply Voltage

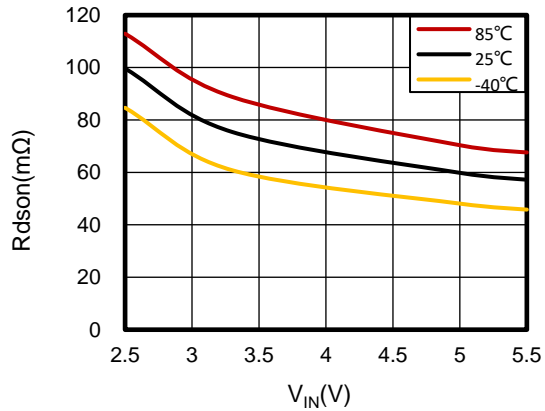

Figure 5. High-side MOSFET On Resistance vs Supply Voltage

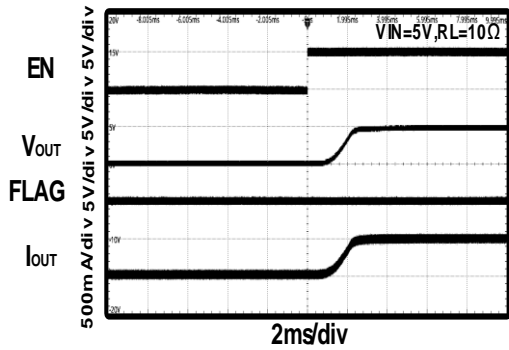

Figure 6. Turn-On Delay Time

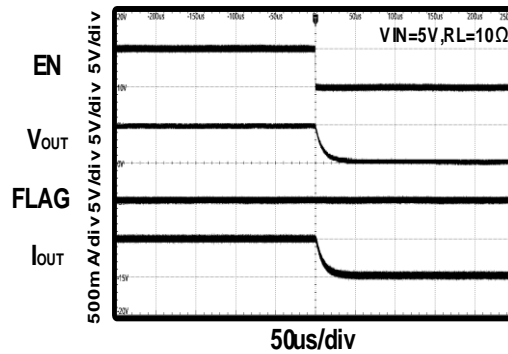

Figure 7. Turn-Off Delay Time

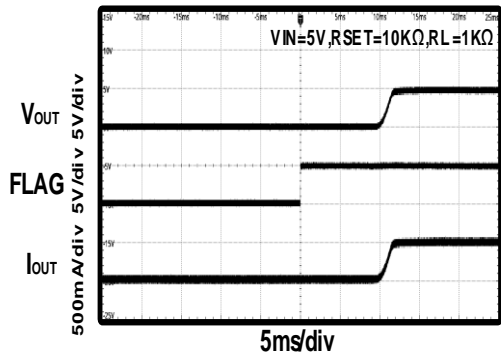

Figure 8. Exit Over Temperature Protection

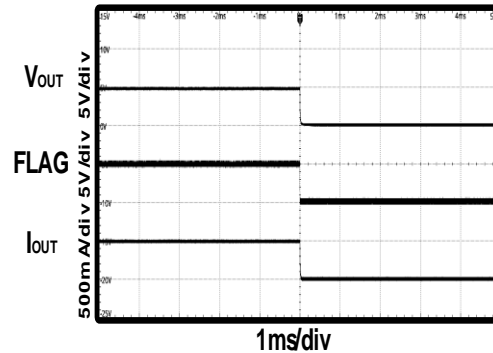

Figure 9. Enter Over Temperature Protection

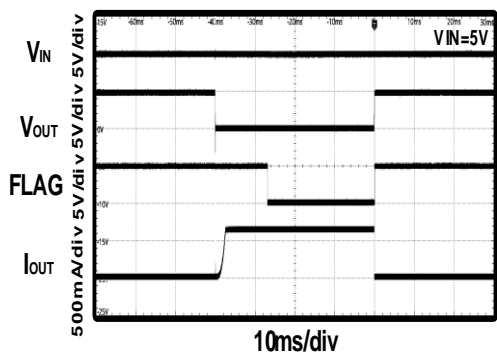

Figure 10. No Load into Short-Circuit

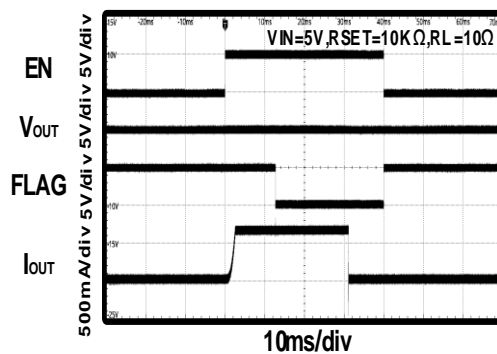

Figure 11. Device Enabled into Short-Circuit

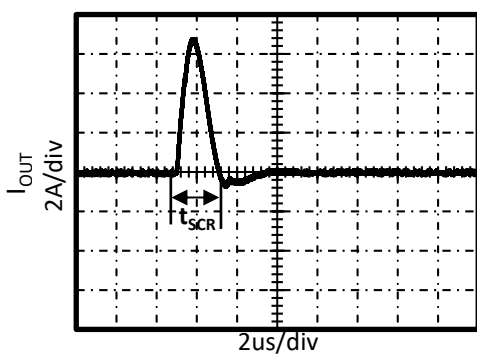

Figure 12. Short-Circuit Response Time

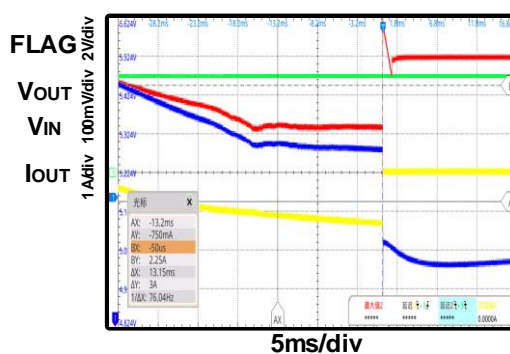

Figure 13. Reverse Input-Output Voltage Protection

9 DETAILED DESCRIPTION

9.1 Input and Output

V_{IN} is the power supply connection to the logic circuitry and the source of the P-channel MOSFET. OUT is the drain of the P-channel MOSFET. In a typical circuit, current flows from V_{IN} to OUT toward the load. The output P-channel MOSFET and driver circuit are also designed to allow the MOSFET drain to be externally forced to a higher voltage than the source (V_{OUT}>V_{IN}) when the switch is disabled.

9.2 Thermal Shutdown

Thermal shutdown is employed to protect device and load from damage because of excessive power dissipation. It shuts off the output MOSFET and asserts the FLAG output, if the die temperature exceeds 150°C until the die temperature drops to 130°C.

9.3 Soft-Start

In order to eliminate the upstream voltage sag caused by the large inrush current during hot-plug events, the soft-start feature effectively isolates power supplies from such highly capacitive loads.

9.4 Under-Voltage Lockout (UVLO)

UVLO prevents the MOSFET switch from turning on until input voltage exceeds 1.9 (Typical). If input voltage drops below 1.8V (Typical), UVLO shuts off the MOSFET switch. Under-voltage detection functions only when the switch is enabled.

9.5 Current Limiting and Short-Circuit Protection

The current limit circuit is designed to limit the output current to protect the upstream power supply. Current limit threshold is programmed with a resistor from SET to ground marked as R_{SET}. It can be estimated by the following equation:

$$I_{LIMIT} = \frac{12320}{R_{SET}}, I_{SHORT} = 0.75 * \frac{12320}{R_{SET}}, R_{SET} \leq 24k\Omega$$

Under output short-circuit condition; the typical current limit folded back 75%. If the RS2599 keeps at over-current condition for a long time, the junction temperature may exceed 150°C, and over-temperature protection will shut down the output until temperature drops 130°C or limit (short-circuit) condition is removed.

9.6 Reverse-Voltage Protection

The reverse-voltage protection feature turns off the MOSFET switch whenever the output voltage exceeds the input voltage by 50mV (Typical). Its hysteresis voltage is 20mV (Typical). The Output reverse-voltage deglitch time is 13ms (Typical).

9.7 Fault Flag (FLAG)

The signal is an open-drain N-MOSFET output. FLAG is asserted (active low) when an over-current, short-circuit or thermal shutdown condition occurs.

In the case of an over-current condition, FLAG will be asserted only after the response delay time (t_D) has elapsed. This ensures that FLAG is asserted only upon valid over-current condition and that erroneous error reporting is eliminated.

False over-current condition can occur during hot-plug events when a highly capacitive load is connected and causes a high transient inrush current that exceeds the current limit threshold for up to 1ms. The FLAG response delay time t_D is 13ms (Typical).

9.8 Power Dissipation

The device's junction temperature depends on several factors such as the load, PCB layout, ambient temperature, and package type. Equations that can be used to calculate power dissipation and junction temperature are found below:

$$P_D = R_{DS(ON)} \times I_{OUT}^2$$

To relate this to junction temperature, the following equation can be used:

$$T_J = P_D \times \theta_{JA} + T_A$$

Where:

T_J = junction temperature
 T_A = ambient temperature
 θ_{JA} = the thermal resistance of the package

9.9 Supply Filter Capacitor

In order to prevent the input voltage drooping during hot-plug events, connect a ceramic capacitor (C_{IN}) from VIN to GND. The C_{IN} is positioned close to VIN and GND of the device. However, higher capacitor values could reduce the voltage sag on the input further. Furthermore, an output short will cause ringing on the input without the input capacitor. It could destroy the internal circuitry when the input transient exceeds 6.0V which is the absolute maximum supply voltage even for a short duration.

If the upstream supply cable is long or the VIN transient exceeds 6.0V during the V_{OUT} short, recommend adding a second filter capacitor (not less than 47 μ F) at the upstream supply output terminal.

9.10 Output Filter Capacitor

A low-ESR 10 μ F ceramic capacitor between OUT and GND is strongly recommended to reduce the voltage droop during hot-attachment of downstream peripheral. Higher value output capacitor is better when the output load is heavy. Additionally, bypassing the output with a 0.1 μ F ceramic capacitor improves the immunity of the device to short-circuit transients.

9.11 PCB Layout Guide

For best performance of the RS2599, the following guidelines must be strictly followed:

1. Please place the input capacitors near the VIN pin as close as possible.
2. Keep VIN and OUT traces as wide and short as possible.
3. Locate RS2599 and output capacitors near the load to reduce parasitic resistance and inductance for excellent load transient performance.
4. Input and output capacitors should be placed closed to the IC and connected to ground plane to reduce noise coupling. Place a ground plane under all circuitry to lower both resistance and inductance and improve DC and transient performance
5. The traces routing the R_{LIM} resistor to the RS2599 should be as short as possible to reduce parasitic effects on the current limit accuracy.

10 PACKAGE OUTLINE DIMENSIONS

DFN3x3-8L

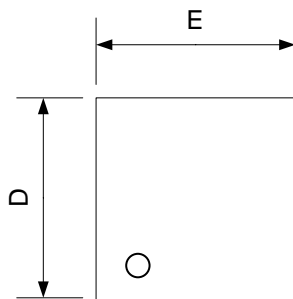
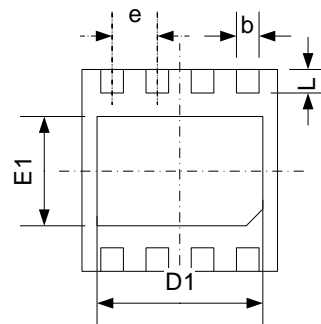
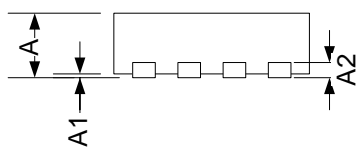
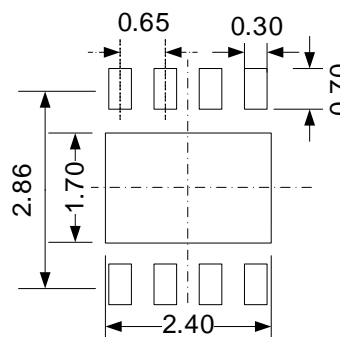
TOP VIEW

BOTTOM VIEW

SIDE VIEW

RECOMMENDED LAND PATTERN (Unit: mm)

Symbol	Dimensions In Millimeters		Dimensions In Inches	
	Min	Max	Min	Max
A	0.700	0.800	0.028	0.031
A1	0.000	0.050	0.000	0.002
A2	0.203		0.008	
b	0.250	0.350	0.010	0.014
D	2.900	3.100	0.114	0.122
D1	2.350	2.450	0.093	0.096
E	2.900	3.100	0.114	0.122
E1	1.650	1.750	0.065	0.069
e	0.650 TYP		0.026 TYP	
L	0.370	0.470	0.015	0.019

NOTE:

- A. All linear dimension is in millimeters.
- B. This drawing is subject to change without notice.
- C. Body dimensions do not include mold flash or protrusion. Mold flash and protrusion shall not exceed 0.15 per side.

11 TAPE AND REEL INFORMATION

REEL DIMENSIONS

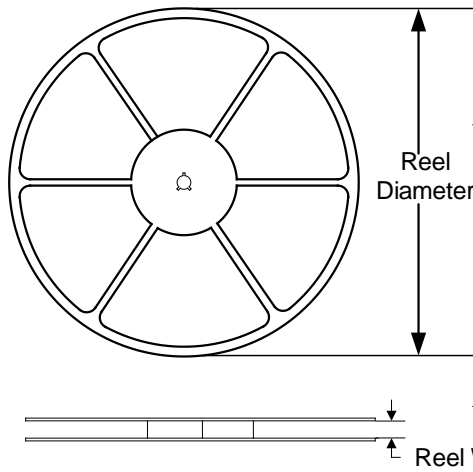

TAPE DIMENSION

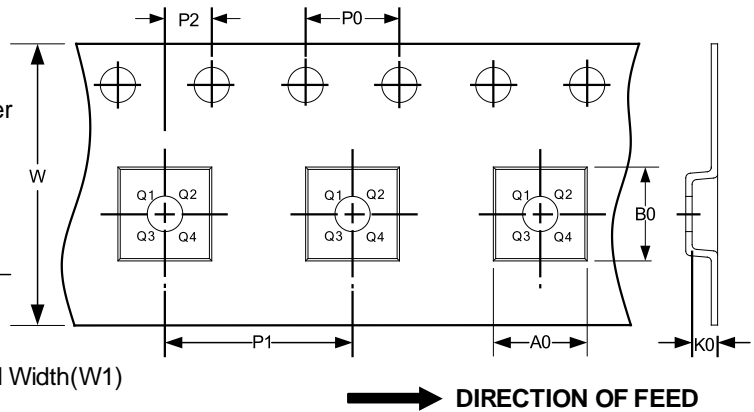

NOTE: The picture is only for reference. Please make the object as the standard.

KEY PARAMETER LIST OF TAPE AND REEL

Package Type	Reel Diameter	Reel Width (mm)	A0 (mm)	B0 (mm)	K0 (mm)	P0 (mm)	P1 (mm)	P2 (mm)	W (mm)	Pin1 Quadrant
DFN3x3-8L	13"	12.4	3.35	3.35	1.13	4.0	8.0	2.0	12.0	Q1

NOTE:

1. All dimensions are nominal.
2. Plastic or metal protrusions of 0.15mm maximum per side are not included.

IMPORTANT NOTICE AND DISCLAIMER

Jiangsu Runic Technology Co., Ltd. will accurately and reliably provide technical and reliability data (including data sheets), design resources (including reference designs), application or other design advice, WEB tools, safety information and other resources, without warranty of any defect, and will not make any express or implied warranty, including but not limited to the warranty of merchantability Implied warranty that it is suitable for a specific purpose or does not infringe the intellectual property rights of any third party.

These resources are intended for skilled developers designing with Runic products You will be solely responsible for: (1) Selecting the appropriate products for your application; (2) Designing, validating and testing your application; (3) Ensuring your application meets applicable standards and any other safety, security or other requirements; (4) Runic and the Runic logo are registered trademarks of Runic Incorporated. All trademarks are the property of their respective owners; (5) For change details, review the revision history included in any revised document. The resources are subject to change without notice. Our company will not be liable for the use of this product and the infringement of patents or third-party intellectual property rights due to its use.