

13MHz, Rail-to-Rail I/O CMOS Operational Amplifier

1 FEATURES

- Qualified for Automotive Applications
- AEC-Q100 Qualified with the Grade 1
- HIGH GAIN BANDWIDTH: 13MHz
- RAIL-TO-RAIL INPUT AND OUTPUT
±0.5mV Typical Vos
- INPUT VOLTAGE RANGE: -0.1V to +5.6V
with $V_S = 5.5V$
- SUPPLY RANGE: +2.7V to +5.5V
- SPECIFIED UP TO +125°C
- Micro SIZE PACKAGES: SOT23-5, SOIC-8

2 APPLICATIONS

- SENSORS
- PHOTODIODE AMPLIFICATION
- ACTIVE FILTERS
- TEST EQUIPMENT
- DRIVING A/D CONVERTERS

3 DESCRIPTIONS

The RS72XP-Q1 families of products offer low voltage operation and rail-to-rail input and output, as well as excellent speed/power consumption ratio, providing an excellent bandwidth (13MHz) and slew rate of 8V/us. The op-amps are unity gain stable and feature an ultra-low input bias current.

The devices are ideal for sensor interfaces, active filters and portable applications. The RS72XP-Q1 families of operational amplifiers are specified at the full temperature range of -40°C to +125°C under single or dual power supplies of 2.7V to 5.5V.

Device Information⁽¹⁾

PART NUMBER	PACKAGE	BODY SIZE (NOM)
RS721P-Q1	SOT23-5	2.92mm×1.62mm
RS722P-Q1	SOIC-8(SOP8)	4.90mm×3.90mm
	MSOP-8	3.00mm×3.00mm

(1) For all available packages, see the orderable addendum at the end of the data sheet.

Table of Contents

1 FEATURES	1
2 APPLICATIONS	1
3 DESCRIPTIONS	1
4 Revision History	3
5 PACKAGE/ORDERING INFORMATION ⁽¹⁾	4
6 Pin Configuration and Functions (Top View)	5
7 SPECIFICATIONS	7
7.1 Absolute Maximum Ratings	7
7.2 ESD Ratings.....	7
7.3 Recommended Operating Conditions.....	7
7.4 ELECTRICAL CHARACTERISTICS.....	8
7.5 TYPICAL CHARACTERISTICS	10
8 Detailed Description	11
8.1 Overview	12
8.2 Phase Reversal Protection	12
8.3 EMIRR IN+ Test Configuration	12
9 Application and Implementation	13
9.1 APPLICATION NOTE	13
9.2 25-kHz Low-pass Filter	13
9.3 Design Requirements	13
9.4 Detailed Design Procedure	13
9.5 Application Curve	14
10 LAYOUTS	15
10.1 Layout Guidelines	15
10.2 Layout Example	15
11 PACKAGE OUTLINE DIMENSIONS	16
12 TAPE AND REEL INFORMATION	20

4 Revision History

Note: Page numbers for previous revisions may differ from page numbers in the current version.

VERSION	Change Date	Change Item
A.1	2022/10/18	Official version completed
A.2	2023/02/16	1. Update IB/I _{OS} in 7.4 ELECTRICAL CHARACTERISTICS 2. Add I _{OS} , PSRR, CMRR curve in 7.5 TYPICAL CHARACTERISTICS 3. Update PACKAGE OUTLINE DIMENSIONS
A.3	2023/07/03	Delete RS724P-Q1 related content

5 PACKAGE/ORDERING INFORMATION (1)

Orderable Device	Package Type	Pin	Channel	Lead finish/Ball material (2)	MSL Peak Temp (3)	Op Temp(°C)	Device Marking (4)	Package Qty
RS721PXF-Q1	SOT23-5	5	1	NIPDAUAG	MSL1-260° -Unlimited	-40°C ~125°C	721P	Tape and Reel,3000
RS722PXX-Q1	SOIC-8 (SOP8)	8	2	NIPDAUAG	MSL1-260° -Unlimited	-40°C ~125°C	RS722P	Tape and Reel,4000
RS722PXM-Q1	MSOP-8	8	2	NIPDAUAG	MSL1-260° -Unlimited	-40°C ~125°C	RS722P	Tape and Reel,4000

NOTE:

- (1) This information is the most current data available for the designated devices. This data is subject to change without notice and revision of this document. For browser-based versions of this data sheet, refer to the right-hand navigation.
- (2) Lead finish/Ball material. Orderable Devices may have multiple material finish options. Finish options are separated by a vertical ruled line. Lead finish/Ball material values may wrap to two lines if the finish value exceeds the maximum column width.
- (3) MSL Peak Temp. The Moisture Sensitivity Level rating according to the JEDEC industry standard classifications, and peak solder temperature.
- (4) There may be additional marking, which relates to the lot trace code information (data code and vendor code), the logo or the environmental category on the device.

6 Pin Configuration and Functions (Top View)

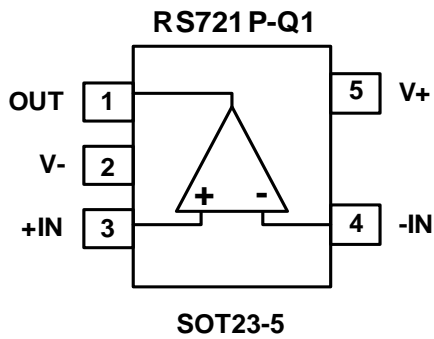

Pin Description

NAME	PIN		I/O ⁽¹⁾	DESCRIPTION
	RS721P-Q1			
	SOT23-5			
-IN	4	I	Negative (inverting) input	
+IN	3	I	Positive (noninverting) input	
OUT	1	O	Output	
V-	2	-	Negative (lowest) power supply	
V+	5	-	Positive (highest) power supply	

(1) I = Input, O = Output.

Pin Configuration and Functions (Top View)

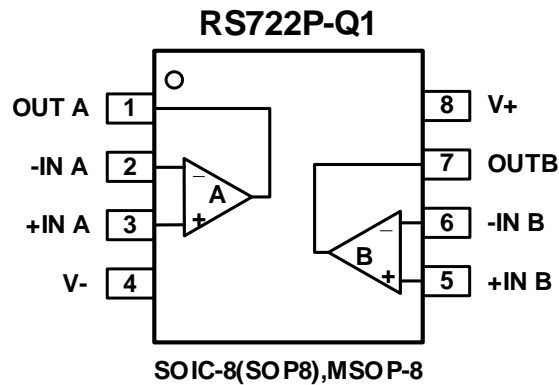

Pin Description

NAME	PIN		I/O ⁽¹⁾	DESCRIPTION
	RS722P-Q1			
	SOIC-8(SOP8)/MSOP-8			
-INA	2		I	Inverting input, channel A
+INA	3		I	Noninverting input, channel A
-INB	6		I	Inverting input, channel B
+INB	5		I	Noninverting input, channel B
OUTA	1		O	Output, channel A
OUTB	7		O	Output, channel B
V-	4		-	Negative (lowest) power supply
V+	8		-	Positive (highest) power supply

(1) I = Input, O = Output.

7 SPECIFICATIONS

7.1 Absolute Maximum Ratings

Over operating free-air temperature range (unless otherwise noted) ⁽¹⁾

		MIN	MAX	UNIT
Voltage	Supply, $V_S=(V+) - (V-)$		7	V
	Signal input pin ⁽²⁾	(V-)-0.5	(V+) +0.5	
	Signal output pin ⁽³⁾	(V-)-0.5	(V+) +0.5	
Current	Signal input pin ⁽²⁾	-10	10	mA
	Signal output pin ⁽³⁾	-200	200	mA
	Output short-circuits ⁽⁴⁾	Continuous		
θ_{JA}	Package thermal impedance ⁽⁵⁾	SOT23-5	230	°C/W
		SOIC-8(SOP8)	110	
		MSOP-8	170	
Temperature	Operating range, T_A	-40	125	°C
	Junction, T_J ⁽⁶⁾	-40	150	
	Storage, T_{stg}	-65	150	

(1) Stresses above these ratings may cause permanent damage. Exposure to absolute maximum conditions for extended periods may degrade device reliability. These are stress ratings only, and functional operation of the device at these or any other conditions beyond those specified is not implied.

(2) Input terminals are diode-clamped to the power-supply rails. Input signals that can swing more than 0.5V beyond the supply rails should be current-limited to 10mA or less.

(3) Output terminals are diode-clamped to the power-supply rails. Output signals that can swing more than 0.5V beyond the supply rails should be current-limited to ± 200 mA or less.

(4) Short-circuit to ground, one amplifier per package.

(5) The package thermal impedance is calculated in accordance with JESD-51.

(6) The maximum power dissipation is a function of $T_{J(MAX)}$, $R_{\theta JA}$, and T_A . The maximum allowable power dissipation at any ambient temperature is $P_D = (T_{J(MAX)} - T_A) / R_{\theta JA}$. All numbers apply for packages soldered directly onto a PCB.

7.2 ESD Ratings

The following ESD information is provided for handling of ESD-sensitive devices in an ESD protected area only.

			VALUE	UNIT
$V_{(ESD)}$	Electrostatic discharge	Human-Body Model (HBM), per AEC Q100-002 ⁽¹⁾	± 2000	V
		Charged-Device Model (CDM), per AEC Q100-011	± 500	
		Latch-Up (LU), per AEC Q100-004	± 100	mA

(1) AEC Q100-002 indicates that HBM stressing shall be in accordance with the ANSI/ESDA/JEDEC JS-001 specification.



ESD SENSITIVITY CAUTION

ESD damage can range from subtle performance degradation to complete device failure. Precision integrated circuits may be more susceptible to damage because very small parametric changes could cause the device not to meet its published specifications.

7.3 Recommended Operating Conditions

Over operating free-air temperature range (unless otherwise noted).

		MIN	NOM	MAX	UNIT
Supply voltage, $V_S=(V+) - (V-)$	Single-supply	2.7		5.5	V
	Dual-supply	± 1.35		± 2.75	

7.4 ELECTRICAL CHARACTERISTICS

(At $T_A = +25^\circ\text{C}$, $V_S = 2.7\text{V}$ to 5.5V , $R_L = 10\text{k}\Omega$ connected to $V_S/2$, and $V_{OUT} = V_S/2$, Full ⁽⁹⁾ = -40°C to $+125^\circ\text{C}$, unless otherwise noted.) ⁽¹⁾

PARAMETER		CONDITIONS	T_J	RS72XP-Q1			
				MIN ⁽²⁾	TYP ⁽³⁾	MAX ⁽²⁾	UNIT
POWER SUPPLY							
V_S	Operating Voltage Range		25°C	2.7		5.5	V
I_Q	Quiescent Current/Amplifier	$V_S = \pm 2.5\text{V}$, $I_O = 0\text{mA}$	25°C		1.15	1.35	mA
			Full			1.85	
PSRR	Power-Supply Rejection Ratio	$V_S = 2.7\text{V}$ to 5.5V	25°C	75	93		dB
			Full	70			
INPUT							
V_{OS}	Input Offset Voltage	$V_{CM} = V_S/2$	25°C	-1.5	± 0.5	1.5	mV
			Full	-3		3	
$V_{OS} T_C$	Input Offset Voltage Average Drift		Full		± 2.6		$\mu\text{V}/^\circ\text{C}$
I_B	Input Bias Current ^{(4) (5)}	$V_{CM} = V_S/2$	25°C		± 1	± 10	pA
			Full		0.5	± 10	
I_{OS}	Input Offset Current ⁽⁵⁾	$V_{CM} = V_S/2$	25°C		± 1	± 10	pA
			Full			± 10	
V_{CM}	Common-Mode Voltage Range	$V_S = 5.5\text{V}$	25°C	-0.1		5.6	V
CMRR	Common-Mode Rejection Ratio	$V_S = 5.5\text{V}$, $V_{CM} = -0.1\text{V}$ to 3.5V	25°C	73	90		dB
			Full	70			
		$V_S = 5.5\text{V}$, $V_{CM} = -0.1\text{V}$ to 5.6V	25°C	60	77		
			Full	59			
OUTPUT							
A_{OL}	Open-Loop Voltage Gain	$R_L = 10\text{k}\Omega$, $V_O = (V_-) + 0.1\text{V}$ to $(V_+) - 0.1\text{V}$	25°C	110	127		dB
			Full	94			
	Output Swing from Rail	$V_S = \pm 2.5\text{V}$, $R_L = 10\text{k}\Omega$	25°C		10	20	mV
			Full			25	
I_{OUT}	Output Short-Circuit Current ^{(6) (7)}	$V_S = \pm 2.5\text{V}$, $V_O = 0\text{V}$	25°C	± 80	± 150		mA
			Full	± 60			
C_{LOAD}	Capacitive Load Drive		25°C		100		pF
FREQUENCY RESPONSE							
SR	Slew Rate ⁽⁸⁾	$G = +1$, $C_L = 100\text{pF}$	25°C		8		V/ μs
GBP	Gain-Bandwidth Product		25°C		13		MHz
t_s	Settling Time, 0.1%	$V_S = \pm 2.5\text{V}$, $G = +1$, $C_L = 100\text{pF}$, Step = 2V	25°C		0.8		μs
t_{OR}	Overload Recovery Time	$V_{IN} \cdot \text{Gain} \geq V_S$, $G = -10$	25°C		0.4		μs
NOISE							
E_n	Input Voltage Noise	$f = 0.1\text{Hz}$ to 10Hz , $V_S = \pm 2.5\text{V}$	25°C		5		μV_{PP}

NOTE:

- (1) Electrical table values apply only for factory testing conditions at the temperature indicated. Factory testing conditions result in very limited self-heating of the device.
- (2) Limits are 100% production tested at 25°C. Limits over the operating temperature range are ensured through correlations using statistical quality control (SQC) method.
- (3) Typical values represent the most likely parametric norm as determined at the time of characterization. Actual typical values may vary over time and will also depend on the application and configuration.
- (4) Positive current corresponds to current flowing into the device.
- (5) This parameter is ensured by design and/or characterization and is not tested in production.
- (6) The maximum power dissipation is a function of $T_{J(MAX)}$, $R_{\theta JA}$, and T_A . The maximum allowable power dissipation at any ambient temperature is $PD = (T_{J(MAX)} - T_A) / R_{\theta JA}$. All numbers apply for packages soldered directly onto a PCB.
- (7) Short circuit test is a momentary test.
- (8) Number specified is the slower of positive and negative slew rates.
- (9) Specified by characterization only.

7.5 TYPICAL CHARACTERISTICS

NOTE: The graphs and tables provided following this note are a statistical summary based on a limited number of samples and are provided for informational purposes only.

At $T_A = +25^\circ\text{C}$, $V_S = 5\text{V}$, $R_L = 10\text{k}\Omega$ connected to $V_S/2$, $V_{OUT} = V_S/2$, unless otherwise noted.

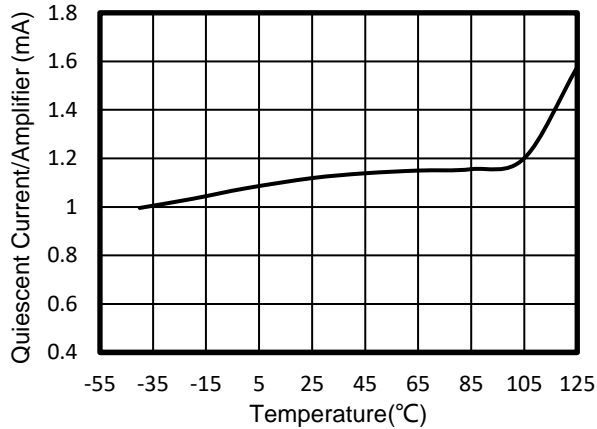

Figure 1. Quiescent Current vs Temperature

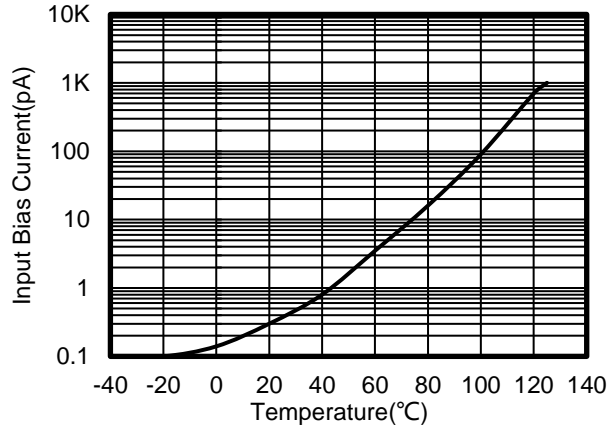

Figure 2. Input Bias Current vs Temperature

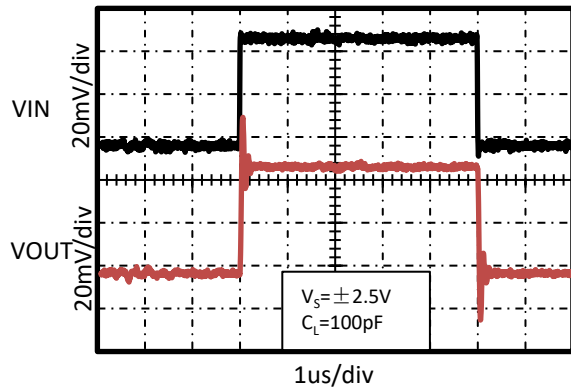

Figure 3. Small-Signal Step Response

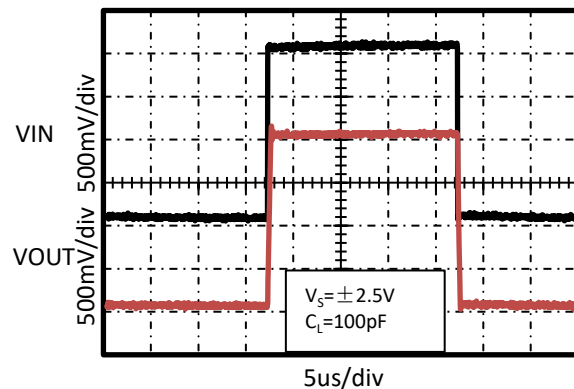

Figure 4. Large-Signal Step Response

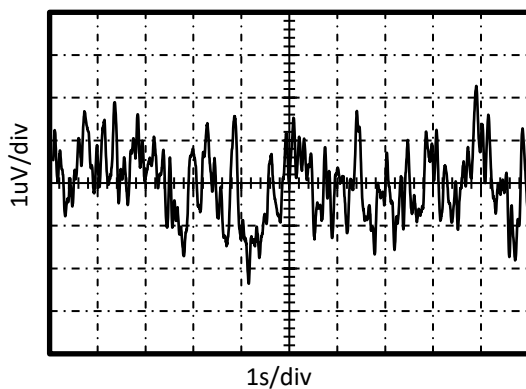

Figure 5. 0.1Hz to 10Hz Input Voltage Noise

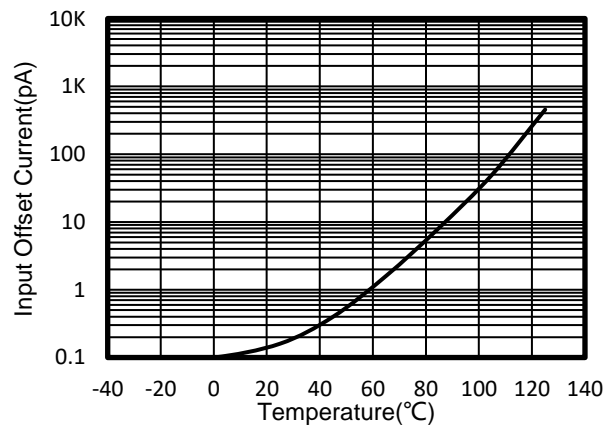

Figure 6. Input Offset Current vs Temperature

TYPICAL CHARACTERISTICS

NOTE: The graphs and tables provided following this note are a statistical summary based on a limited number of samples and are provided for informational purposes only.

At $T_A = +25^\circ\text{C}$, $V_S = 5\text{V}$, $R_L = 10\text{k}\Omega$ connected to $V_S/2$, $V_{OUT} = V_S/2$, unless otherwise noted.

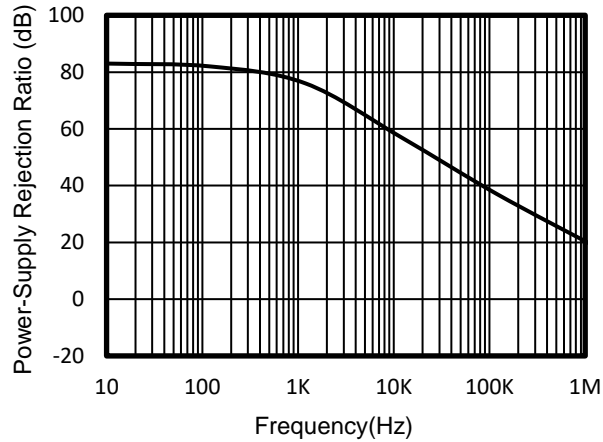

Figure 7. PSRR vs Frequency

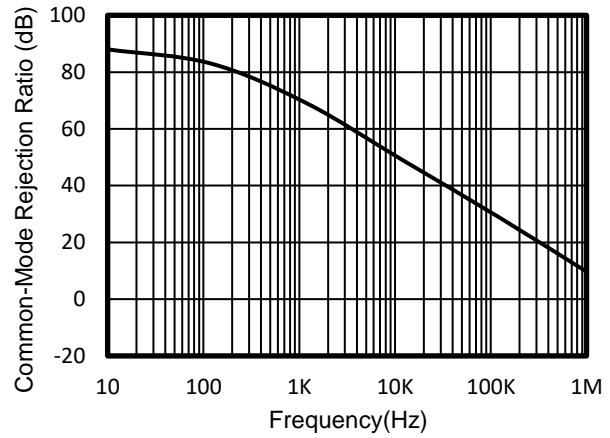

Figure 8. CMRR vs Frequency

8 Detailed Description

8.1 Overview

The RS721P-Q1, RS722P-Q1 are high precision, rail-to-rail operational amplifiers that can be run from a single-supply voltage 2.7V to 5.5V ($\pm 1.35V$ to $\pm 2.75V$). Supply voltages higher than 7V (absolute maximum) can permanently damage the amplifier. Rail-to-rail input and output swing significantly increases dynamic range, especially in low-supply applications. Good layout practice mandates use of a 0.1 μF capacitor placed closely across the supply pins.

8.2 Phase Reversal Protection

The RS72XP-Q1 family has internal phase-reversal protection. Many op amps exhibit phase reversal when the input is driven beyond the linear common-mode range. This condition is most often encountered in noninverting circuits when the input is driven beyond the specified common-mode voltage range, causing the output to reverse into the opposite rail. The input of the RS72XP-Q1 prevents phase reversal with excessive common-mode voltage. Instead, the appropriate rail limits the output voltage. This performance is shown in figure 9.

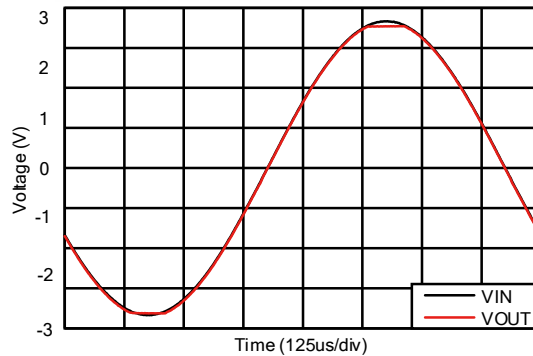

Figure 9. Output Waveform Devoid of Phase Reversal During an Input Overdrive Condition

8.3 EMIRR IN+ Test Configuration

Figure 10 shows the circuit configuration for testing the EMIRR IN+. An RF source is connected to the operational amplifier noninverting input pin using a transmission line. The operational amplifier is configured in a unity-gain buffer topology with the output connected to a low-pass filter (LPF) and a digital multimeter (DMM). A large impedance mismatch at the operational amplifier input causes a voltage reflection; however, this effect is characterized and accounted for when determining the EMIRR IN+. The resulting dc offset voltage is sampled and measured by the multimeter. The LPF isolates the multimeter from residual RF signals that can interfere with multimeter accuracy.

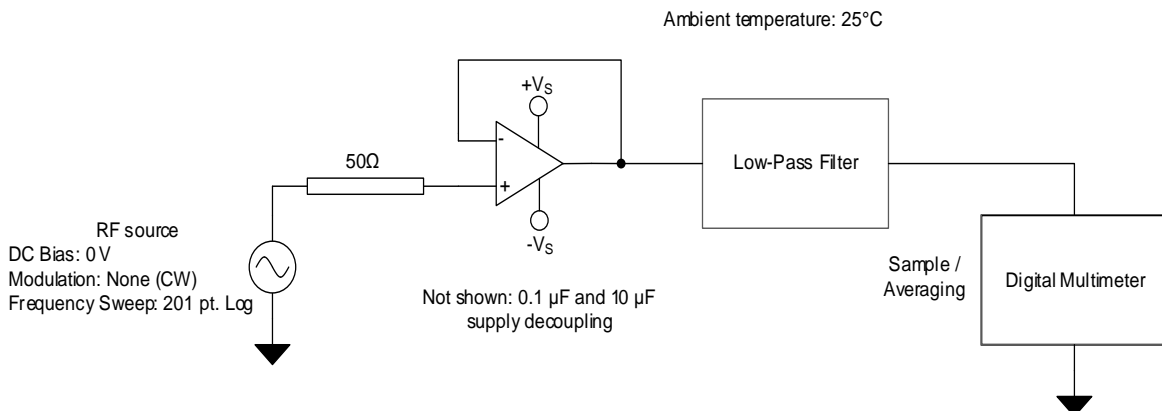

Figure 10. EMIRR IN+ Test Configuration Schematic

9 Application and Implementation

Information in the following applications sections is not part of the Runic component specification, and Runic does not warrant its accuracy or completeness. Runic's customers are responsible for determining suitability of components for their purposes. Customers should validate and test their design implementation to confirm system functionality.

9.1 APPLICATION NOTE

The RS72XP-Q1 are high precision, rail-to-rail operational amplifiers that can be run from a single-supply voltage 2.7V to 5.5V ($\pm 1.35V$ to $\pm 2.75V$). Supply voltages higher than 7V (absolute maximum) can permanently damage the amplifier. Rail-to-rail input and output swing significantly increases dynamic range, especially in low-supply applications. Good layout practice mandates use of a 0.1 μF capacitor placed closely across the supply pins.

Typical Applications

9.2 25-kHz Low-pass Filter

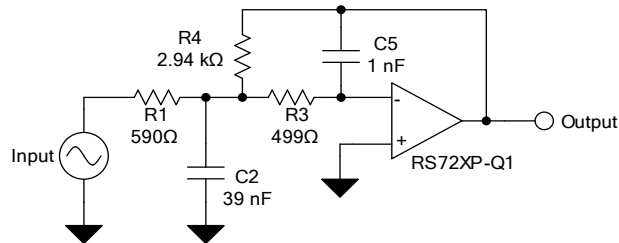

Figure 11. 25-kHz Low-Pass Filter

9.3 Design Requirements

Low-pass filters are commonly employed in signal processing applications to reduce noise and prevent aliasing. The RS72XP-Q1 devices are ideally suited to construct high-speed, high-precision active filters. Figure 11 shows a second-order, low-pass filter commonly encountered in signal processing applications.

Use the following parameters for this design example:

- Gain = 5 V/V (inverting gain)
- Low-pass cutoff frequency = 25 kHz
- Second-order Chebyshev filter response with 3-dB gain peaking in the passband.

9.4 Detailed Design Procedure

The infinite-gain multiple-feedback circuit for a low-pass network function is shown in Figure 11. Use Equation 1 to calculate the voltage transfer function.

$$\frac{\text{Output}}{\text{Input}}(s) = \frac{-1/R_1 R_3 C_2 C_5}{s^2 + (s/C_2)(1/R_1 + 1/R_3 + 1/R_4) + 1/R_3 R_4 C_2 C_5} \quad (1)$$

This circuit produces a signal inversion. For this circuit, the gain at dc and the low-pass cutoff frequency are calculated by Equation 2:

$$\text{Gain} = \frac{R_4}{R_1}$$

$$f_c = \frac{1}{2\pi} \sqrt{(1/R_3 R_4 C_2 C_5)} \quad (2)$$

9.5 Application Curve

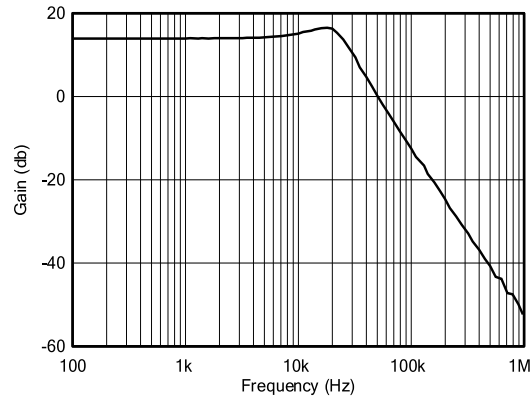

Figure 12. Low-pass filter transfer function

10 LAYOUTS

10.1 Layout Guidelines

Attention to good layout practices is always recommended. Keep traces short. When possible, use a PCB ground plane with surface-mount components placed as close to the device pins as possible. Place a 0.1uF capacitor closely across the supply pins.

These guidelines should be applied throughout the analog circuit to improve performance and provide benefits such as reducing the EMI susceptibility.

10.2 Layout Example

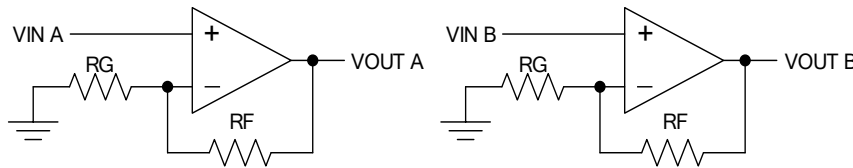

Figure 13. Schematic Representation

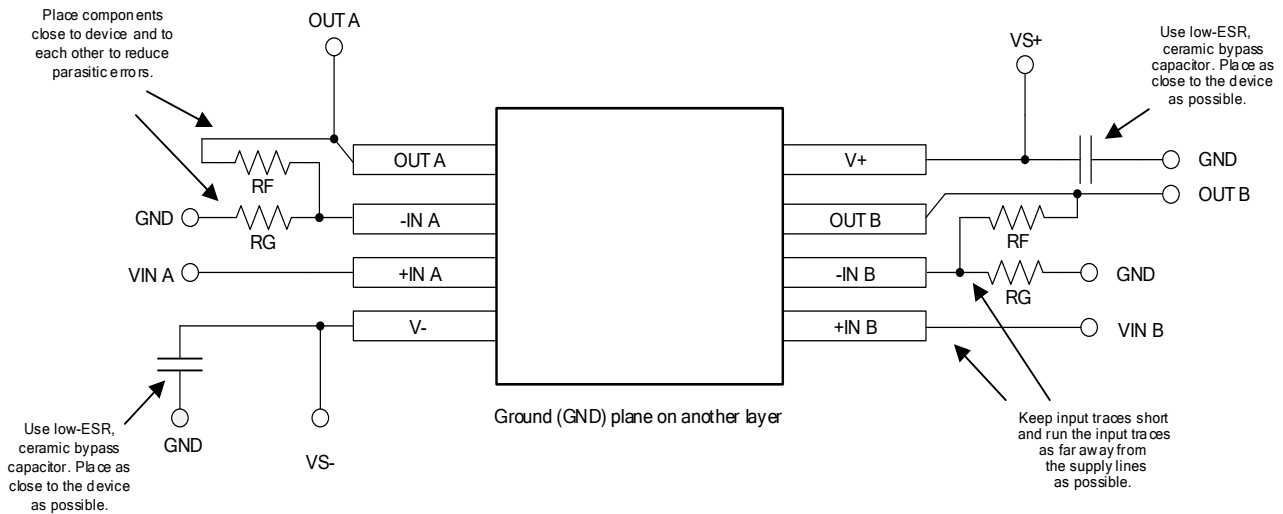
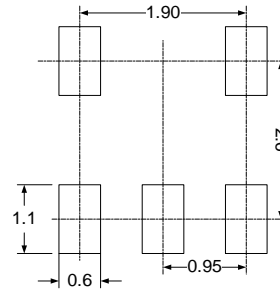
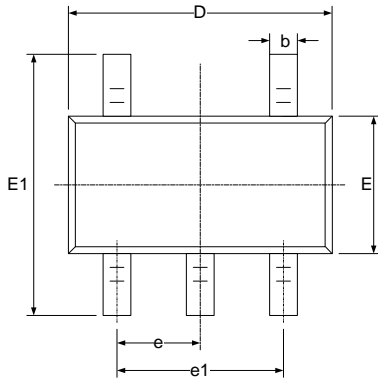

Figure 14. Layout Example

NOTE: Layout Recommendations have been shown for dual op-amp only, follow similar precautions for Single and four.

11 PACKAGE OUTLINE DIMENSIONS

SOT23-5



RECOMMENDED LAND PATTERN (Unit: mm)

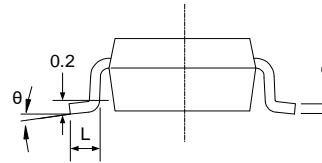
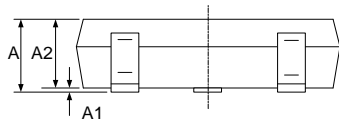

Symbol	Dimensions In Millimeters		Dimensions In Inches	
	Min	Max	Min	Max
A		1.250		0.049
A1	0.000	0.150	0.000	0.006
A2	1.000	1.200	0.039	0.047
b	0.360	0.500	0.014	0.020
c	0.100	0.200	0.004	0.008
D	2.826	3.026	0.111	0.119
E	1.526	1.726	0.060	0.068
E1	2.600	3.000	0.102	0.118
e	0.950(BSC)		0.037(BSC)	
e1	1.800	2.000	0.071	0.079
L	0.350	0.600	0.014	0.024
θ	0°	8°	0°	8°

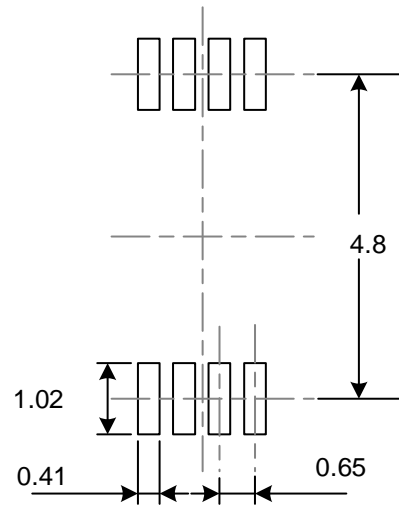
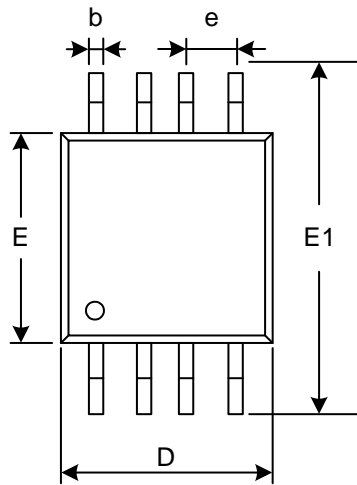
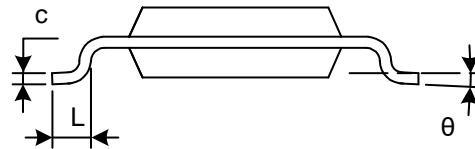
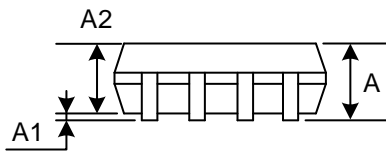
MSOP-8

RECOMMENDED LAND PATTERN (Unit: mm)

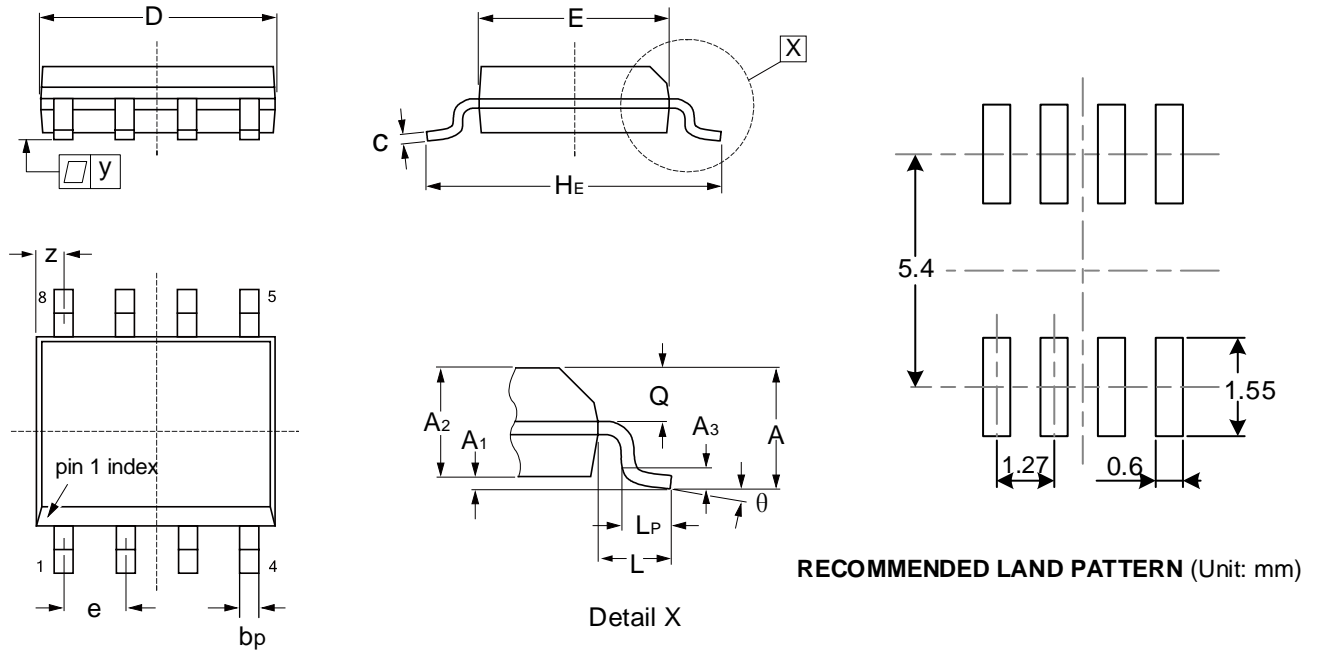
Symbol	Dimensions In Millimeters		Dimensions In Inches	
	Min	Max	Min	Max
A	0.820	1.100	0.032	0.043
A1	0.020	0.150	0.001	0.006
A2	0.750	0.950	0.030	0.037
b	0.250	0.380	0.010	0.015
c	0.090	0.230	0.004	0.009
D	2.900	3.100	0.114	0.122
e	0.650(BSC)		0.026(BSC)	
E	2.900	3.100	0.114	0.122
E1	4.750	5.050	0.187	0.199
L	0.400	0.800	0.016	0.031
θ	0°	6°	0°	6°

SOIC-8(SOP8)

Symbol	Dimensions In Millimeters		Dimensions In Inches	
	Min	Max	Min	Max
A		1.750		0.069
A ₁	0.100	0.250	0.004	0.010
A ₂	1.250	1.450	0.049	0.057
A ₃	0.25		0.010	
b _p	0.360	0.490	0.014	0.019
c	0.190	0.250	0.007	0.010
D ^(A)	4.800	5.000	0.190	0.200
E ^(B)	3.800	4.000	0.150	0.160
H _E	5.800	6.200	0.228	0.244
e	1.270		0.050	
L	1.05		0.041	
L _P	0.400	1.000	0.016	0.039
Q	0.600	0.700	0.024	0.028
Z ^(A)	0.300	0.700	0.012	0.028
y	0.1		0.004	
θ	0°	8°	0°	8°

NOTE:

- A. Plastic or metal protrusions of 0.15mm maximum per side are not included.
- B. Plastic interlead protrusions of 0.25mm maximum per side are not included.
- C. All linear dimension is in millimeters.
- D. This drawing is subject to change without notice.
- E. Body dimensions do not include mold flash or protrusion. Mold flash and protrusion shall not exceed 0.15 per side.
- F. BSC: Basic Dimension. Theoretically exact value shown without tolerances.

12 TAPE AND REEL INFORMATION

REEL DIMENSIONS

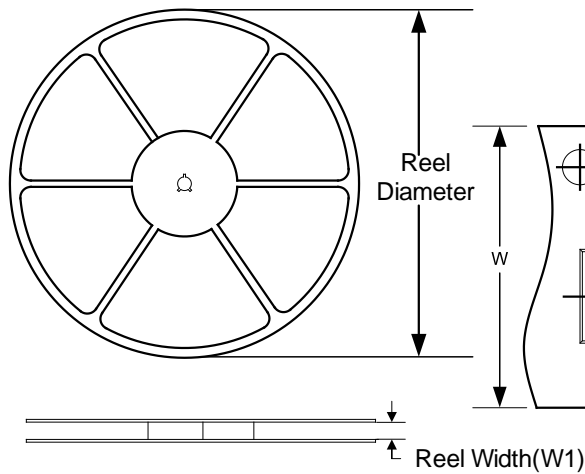

TAPE DIMENSION

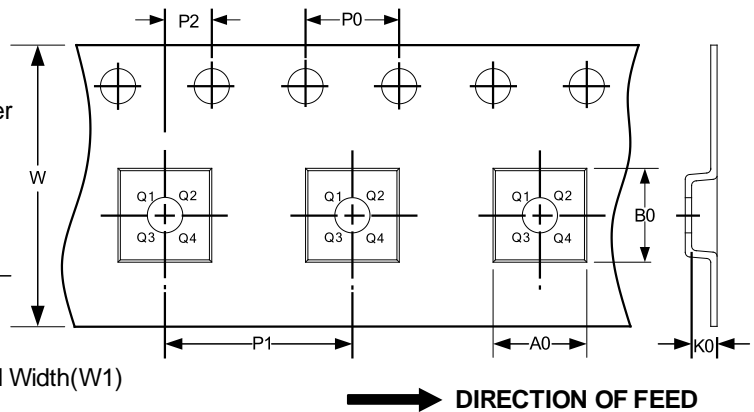

NOTE: The picture is only for reference. Please make the object as the standard.

KEY PARAMETER LIST OF TAPE AND REEL

Package Type	Reel Diameter	Reel Width(mm)	A0 (mm)	B0 (mm)	K0 (mm)	P0 (mm)	P1 (mm)	P2 (mm)	W (mm)	Pin1 Quadrant
SOT23-5	7"	9.5	3.20	3.20	1.40	4.0	4.0	2.0	8.0	Q3
SOIC-8(SOP8)	13"	12.4	6.40	5.40	2.10	4.0	8.0	2.0	12.0	Q1
MSOP-8	13"	12.4	5.20	3.30	1.50	4.0	8.0	2.0	12.0	Q1

NOTE:

1. All dimensions are nominal.
2. Plastic or metal protrusions of 0.15mm maximum per side are not included.

IMPORTANT NOTICE AND DISCLAIMER

Jiangsu Runic Technology Co., Ltd. will accurately and reliably provide technical and reliability data (including data sheets), design resources (including reference designs), application or other design advice, WEB tools, safety information and other resources, without warranty of any defect, and will not make any express or implied warranty, including but not limited to the warranty of merchantability Implied warranty that it is suitable for a specific purpose or does not infringe the intellectual property rights of any third party.

These resources are intended for skilled developers designing with Runic products You will be solely responsible for: (1) Selecting the appropriate products for your application; (2) Designing, validating and testing your application; (3) Ensuring your application meets applicable standards and any other safety, security or other requirements; (4) Runic and the Runic logo are registered trademarks of Runic Incorporated. All trademarks are the property of their respective owners; (5) For change details, review the revision history included in any revised document. The resources are subject to change without notice. Our company will not be liable for the use of this product and the infringement of patents or third-party intellectual property rights due to its use.