

Bidirectional, High or Low Side, Voltage Output, Current Sense Amplifiers

1 FEATURES

- **Wide Common-Mode Range: -0.1V to 26V**
- **Input Offset Voltage: $\pm 50\mu\text{V}$ (Typical)**
- **High Bandwidth: 400kHz (RS181A)**
- **Gain Error: $\pm 1\%$ (Maximum)**
- **Choice of Gains:**
 - RS181A Gain: 20V/V
 - RS181B Gain: 50V/V
 - RS181C Gain: 100V/V
- **Quiescent Current: 210 μA**
- **Supply Range: 3V to 5.5V**
- **-40°C to +125°C Operating Temperature Range**
- **Available in a Green SOT23-6 Package**

2 APPLICATIONS

- **Motor Control**
- **Power Monitoring**
- **Charging Station**
- **Solar Inverters**
- **Precision Current Sources**

3 DESCRIPTIONS

The RS181 series of voltage output, current shunt monitors (also called current-sense amplifiers) can sense drops across shunts at common-mode voltages from -0.1V to 26V, independent of the supply voltage. Three fixed gains are available: 20V/V, 50V/V, 100V/V. The device integrate a matched resistor gain network, this matched gain resistor network minimizes gain error and reduces the temperature drift.

These devices operate from a single 3V to 5.5V power supply, drawing a maximum of 270 μA of supply current. The RS181 families of operational amplifiers are specified at the full temperature range of -40°C to +125°C, and offered in SOT23-6 package.

Device Information⁽¹⁾

| PART NUMBER | PACKAGE | BODY SIZE(NOM) |
|-------------|---------|----------------|
| RS181 | SOT23-6 | 2.90mm×1.60mm |

(1) For all available packages, see the orderable addendum at the end of the data sheet

4 TYPICAL APPLICATION CIRCUIT

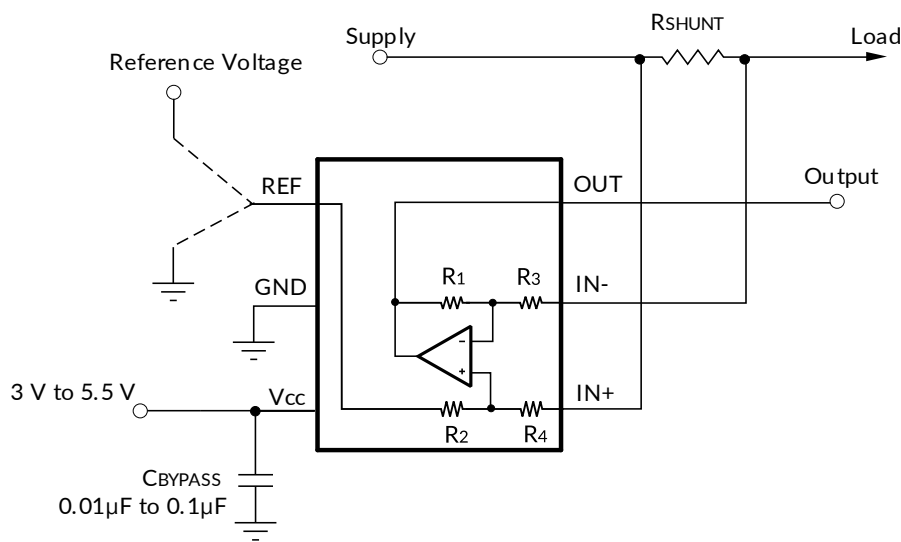

Table of Contents

| | |
|---|----|
| 1 FEATURES | 1 |
| 2 APPLICATIONS | 1 |
| 3 DESCRIPTIONS | 1 |
| 4 TYPICAL APPLICATION CIRCUIT | 1 |
| 5 REVISION HISTORY | 3 |
| 6 PACKAGE/ORDERING INFORMATION ⁽¹⁾ | 4 |
| 7 PIN CONFIGURATION AND FUNCTIONS | 5 |
| 8 SPECIFICATIONS | 6 |
| 8.1 Absolute Maximum Ratings | 6 |
| 8.2 ESD Ratings | 6 |
| 8.3 Recommended Operating Conditions | 6 |
| 8.4 Electrical Characteristics | 7 |
| 8.5 Typical Characteristics | 8 |
| 9 APPLICATION INFORMATION | 12 |
| 9.1 Power Supply | 12 |
| 9.2 Selecting R _{SHUNT} | 12 |
| 9.3 Unidirectional Operation | 12 |
| 9.4 Shutting Down the RS181 Series | 12 |
| 9.5 REF Input Impedance Effects | 13 |
| 9.6 Using the RS181 with Common Mode Transients above 26V | 13 |
| 10 PACKAGE OUTLINE DIMENSIONS | 14 |
| 11 TAPE AND REEL INFORMATION | 15 |

5 REVISION HISTORY

Note: Page numbers for previous revisions may differ from page numbers in the current version.

| Version | Change Date | Change Item |
|----------------|--------------------|---|
| A.0 | 2023/04/03 | Preliminary version completed |
| A.1 | 2024/06/11 | Initial version completed |
| A.2 | 2024/08/22 | 1. Add Choice of Gains: 50V/V, 100V/V 2. Update Electrical Characteristics 3. Add Typical Characteristics Figure 2,3,5,6,8,9,10 |

6 PACKAGE/ORDERING INFORMATION ⁽¹⁾

| Orderable Device | Package Type | Pin | Channel | Op Temp(°C) | Device Marking ⁽²⁾ | MSL ⁽³⁾ | Package Qty |
|------------------|--------------|-----|---------|--------------|-------------------------------|--------------------|---------------------|
| RS181AXH | SOT23-6 | 6 | 1 | -40°C ~125°C | 181A | MSL3 | Tape and Reel, 3000 |
| RS181BXH | SOT23-6 | 6 | 1 | -40°C ~125°C | 181B | MSL3 | Tape and Reel, 3000 |
| RS181CXH | SOT23-6 | 6 | 1 | -40°C ~125°C | 181C | MSL3 | Tape and Reel, 3000 |

NOTE:

- (1) This information is the most current data available for the designated devices. This data is subject to change without notice and revision of this document. For browser-based versions of this data sheet, refer to the right-hand navigation.
- (2) There may be additional marking, which relates to the lot trace code information (data code and vendor code), the logo or the environmental category on the device.
- (3) RUNIC classify the MSL level with using the common preconditioning setting in our assembly factory conforming to the JEDEC industrial standard J-STD-20F. Please align with RUNIC if your end application is quite critical to the preconditioning setting or if you have special requirement.

7 PIN CONFIGURATION AND FUNCTIONS

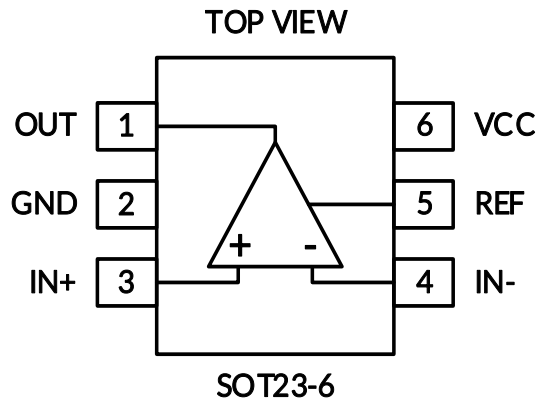

Pin Description

| NAME | PIN | I/O ⁽¹⁾ | DESCRIPTION |
|------|---------|--------------------|-----------------------------------|
| | SOT23-6 | | |
| REF | 5 | I | Reference voltage |
| GND | 2 | - | Ground |
| VCC | 6 | - | Positive power supply, 3V to 5.5V |
| IN+ | 3 | I | Positive (noninverting) input |
| IN- | 4 | I | Negative (inverting) input |
| OUT | 1 | O | Output |

(1) I = Input, O = Output.

8 SPECIFICATIONS

8.1 Absolute Maximum Ratings

Over operating free-air temperature range (unless otherwise noted) ⁽¹⁾

| | | MIN | MAX | UNIT |
|--|--|---------|---------------------|------|
| Supply voltage, V _s | | | 6 | V |
| Analog inputs, IN+, IN- ⁽²⁾ | Differential (V _{IN+}) - (V _{IN-}) | -26 | 26 | |
| | Common-mode ⁽³⁾ | GND-0.3 | 26 | |
| Input voltage range | at REF pin | GND-0.3 | V _s +0.3 | |
| Output voltage | | GND-0.3 | V _s +0.3 | |
| Maximum output current, I _{OUT} | | | 8 | mA |
| θ _{JA} | Package thermal impedance ⁽⁴⁾ | SOT23-6 | | °C/W |
| Temperature | Operating range, T _A | -40 | 125 | °C |
| | Junction, T _J ⁽⁵⁾ | | 150 | |
| | Storage, T _{stg} | -65 | 150 | |

(1) Stresses beyond those listed under Absolute Maximum Ratings may cause permanent damage to the device. These are stress ratings only, which do not imply functional operation of the device at these or any other conditions beyond those indicated under Recommended Operating Conditions. Exposure to absolute-maximum-rated conditions for extended periods may affect device reliability.

(2) V_{IN+} and V_{IN-} are the voltages at the IN+ and IN- pins, respectively.

(3) Input voltage at any pin can exceed the voltage shown if the current at that pin is limited to 5 mA.

(4) The package thermal impedance is calculated in accordance with JESD-51.

(5) The maximum power dissipation is a function of T_{J(MAX)}, R_{θJA}, and T_A. The maximum allowable power dissipation at any ambient temperature is P_D = (T_{J(MAX)} - T_A) / R_{θJA}. All numbers apply for packages soldered directly onto a PCB.

8.2 ESD Ratings

The following ESD information is provided for handling of ESD-sensitive devices in an ESD protected area only.

| | | VALUE | UNIT |
|--------------------|-------------------------|---|-------|
| V _(ESD) | Electrostatic discharge | Human-Body Model (HBM), MIL-STD-883K METHOD 3015.9 | ±2000 |
| | | Charged-Device Model (CDM), ANSI/ESDA/JEDEC JS-002-2022 | ±1500 |



ESD SENSITIVITY CAUTION

ESD damage can range from subtle performance degradation to complete device failure. Precision integrated circuits may be more susceptible to damage because very small parametric changes could cause the device not to meet its published specifications.

8.3 Recommended Operating Conditions

Over operating free-air temperature range (unless otherwise noted)

| | | MIN | NOM | MAX | UNIT |
|-----------------|---|------|-----|-----|------|
| V _{CM} | Common-mode input voltage (IN+ and IN-) | -0.1 | 12 | 26 | V |
| V _s | Operating supply voltage | 3 | 5 | 5.5 | V |
| T _A | Operating free-air temperature | -40 | | 125 | °C |

8.4 Electrical Characteristics

At $T_A=25^\circ\text{C}$, $V_S = 5\text{V}$, $V_{\text{REF}} = V_S/2$, $V_{\text{IN}+} = 12\text{V}$, and $V_{\text{SENSE}} = V_{\text{IN}+} - V_{\text{IN}-}$, Full ⁽⁷⁾ = -40°C to $+125^\circ\text{C}$ (unless otherwise noted) ⁽¹⁾

| PARAMETER | | CONDITIONS | T_A | MIN ⁽²⁾ | TYP ⁽³⁾ | MAX ⁽²⁾ | UNIT |
|----------------------------------|---|--|--------------------|--------------------|---------------------------|---------------------------|------------------------------|
| INPUT | | | | | | | |
| CMRR | Common-Mode Rejection Ratio, RTI ⁽⁴⁾ | $V_{\text{IN}+} = 5\text{V to } 26\text{V}$, $V_{\text{SENSE}} = 0\text{mV}$ | Full | 95 | 117 | | dB |
| V_{OS} | Offset Voltage, RTI | $V_{\text{SENSE}} = 0\text{mV}$ | 25°C | -130 | ± 50 | 130 | μV |
| | | $V_{\text{SENSE}} = 0\text{mV}$, $V_{\text{IN}+} = 0\text{V}$ | 25°C | -130 | ± 50 | 130 | μV |
| dV_{OS}/dT | Offset Drift, RTI | $V_{\text{SENSE}} = 0\text{mV}$ | Full | | 0.5 | | $\mu\text{V}/^\circ\text{C}$ |
| PSRR | Power-Supply Rejection Ratio, RTI | $V_S = 3\text{V to } 5.5\text{V}$, $V_{\text{IN}+} = 12\text{V}$, $V_{\text{SENSE}} = 0\text{mV}$ | 25°C | | ± 3 | ± 8 | $\mu\text{V}/\text{V}$ |
| I_{IB} | Input Bias Current | $V_{\text{SENSE}} = 0\text{mV}$, $V_{\text{IN}+} = 0\text{V}$ | 25°C | | -5 | | μA |
| | | $V_{\text{SENSE}} = 0\text{mV}$ | 25°C | | 76 | 100 | μA |
| I_{IO} | Input Offset Current ⁽⁵⁾ | $V_{\text{SENSE}} = 0\text{mV}$ | 25°C | | ± 0.05 | | μA |
| OUTPUT | | | | | | | |
| G | Gain | A devices | 25°C | | 20 | | V/V |
| | | B devices | | | 50 | | |
| | | C devices | | | 100 | | |
| E_G | Gain Error | $V_{\text{OUT}} = 0.5\text{V to } V_S - 0.5\text{V}$ | Full | | $\pm 0.15\%$ | $\pm 1\%$ | |
| | Gain Error vs Temperature | | Full | | 4.5 | 20 | ppm/ $^\circ\text{C}$ |
| | Nonlinearity Error | $V_{\text{OUT}} = 0.5\text{V to } V_S - 0.5\text{V}$ | 25°C | | $\pm 0.025\%$ | | |
| | Maximum Capacitive Load | No sustained oscillation | 25°C | | 1 | | nF |
| VOLTAGE OUTPUT | | | | | | | |
| V_{SP} | Swing to V_S Power-Supply Rail | $R_L = 10\text{k}\Omega$ to $V_S/2$ | Full | | $(V_S) - 0.01$ | $(V_S) - 0.02$ | V |
| V_{SN} | Swing to GND | $R_L = 10\text{k}\Omega$ to $V_S/2$ | Full | | $(V_{\text{GND}}) + 0.01$ | $(V_{\text{GND}}) + 0.02$ | V |
| FREQUENCY RESPONSE | | | | | | | |
| BW | Bandwidth | A devices, $C_{\text{LOAD}} = 10\text{pF}$ | 25°C | | 400 | | kHz |
| | | B devices, $C_{\text{LOAD}} = 10\text{pF}$ | | | 185 | | |
| | | C devices, $C_{\text{LOAD}} = 10\text{pF}$ | | | 165 | | |
| SR | Slew Rate ⁽⁶⁾ | $R_L = 10\text{k}$, $C_{\text{LOAD}} = 10\text{pF}$ | 25°C | | 2 | | V/ μs |
| NOISE, RTI ⁽⁴⁾ | | | | | | | |
| | Voltage Noise Density | | 25°C | | 35 | | $\text{nV}/\sqrt{\text{Hz}}$ |
| | 0.1Hz to 10Hz | | 25°C | | 0.9 | | μV_{PP} |
| POWER SUPPLY | | | | | | | |
| I_Q | Quiescent Current | $V_{\text{SENSE}} = 0\text{mV}$ | 25°C | | 210 | 270 | μA |
| | | | Full | | | 280 | μA |

NOTE:

- (1) Electrical table values apply only for factory testing conditions at the temperature indicated. Factory testing conditions result in very limited self-heating of the device.
- (2) Limits are 100% production tested at 25°C . Limits over the operating temperature range are ensured through correlations using statistical quality control (SQC) method.
- (3) Typical values represent the most likely parametric norm as determined at the time of characterization. Actual typical values may vary over time and will also depend on the application and configuration.
- (4) RTI = referred-to-input
- (5) This parameter is ensured by design and/or characterization and is not tested in production.
- (6) Number specified is the slower of positive and negative slew rates.
- (7) Specified by characterization only.

8.5 Typical Characteristics

NOTE: The graphs and tables provided following this note are a statistical summary based on a limited number of samples and are provided for informational purposes only.

At $T_A = +25^\circ\text{C}$, $V_S = 5\text{V}$, $R_L = 10\text{k}\Omega$, REF connected to $V_S/2$, $V_{OUT} = V_S/2$, unless otherwise noted.

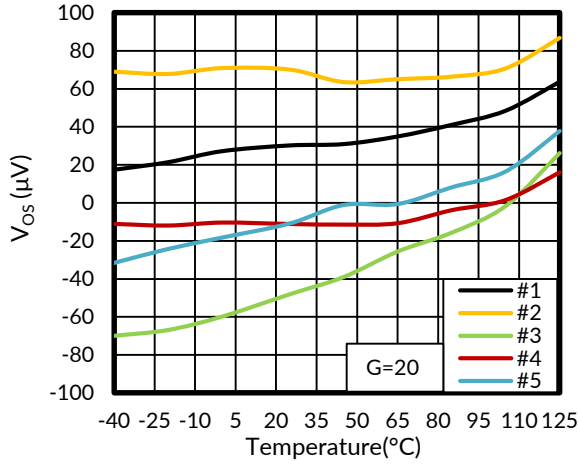

Figure 1. Offset Voltage vs Temperature

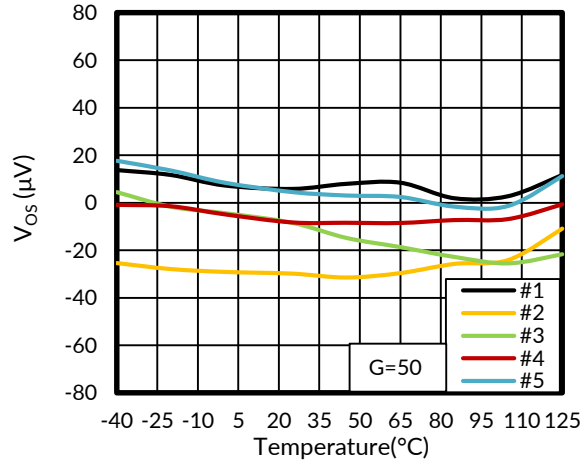

Figure 2. Offset Voltage vs Temperature

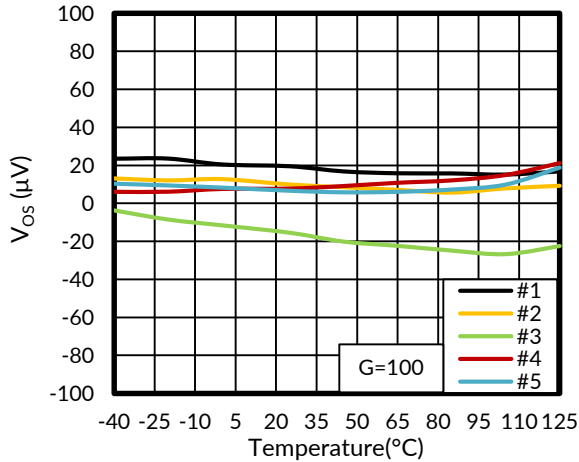

Figure 3. Offset Voltage vs Temperature

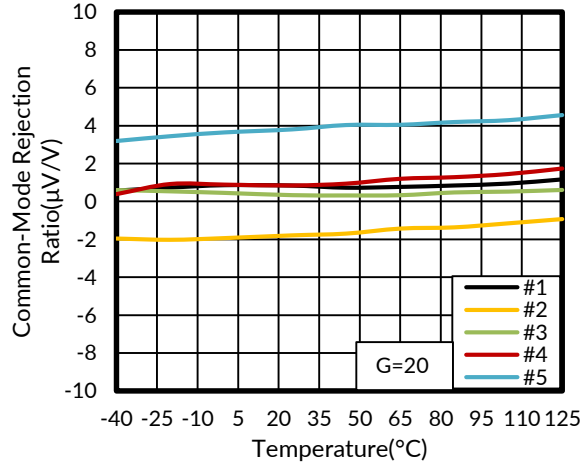

Figure 4. Common-Mode Rejection Ratio vs Temperature

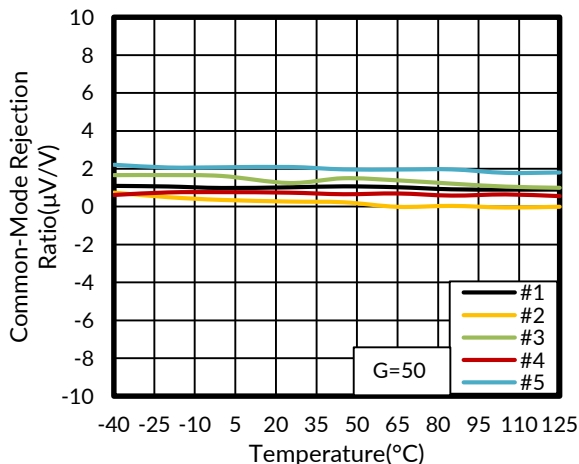

Figure 5. Common-Mode Rejection Ratio vs Temperature

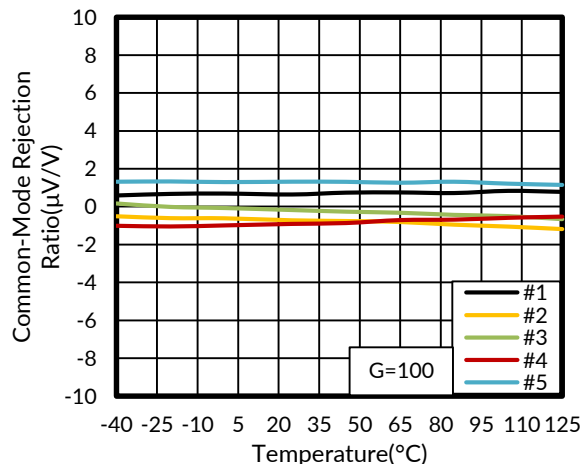

Figure 6. Common-Mode Rejection Ratio vs Temperature

Typical Characteristics

NOTE: The graphs and tables provided following this note are a statistical summary based on a limited number of samples and are provided for informational purposes only.

At $T_A = +25^\circ\text{C}$, $V_S=5\text{V}$, $R_L = 10\text{k}\Omega$, REF connected to $V_S/2$, $V_{OUT} = V_S/2$, unless otherwise noted.

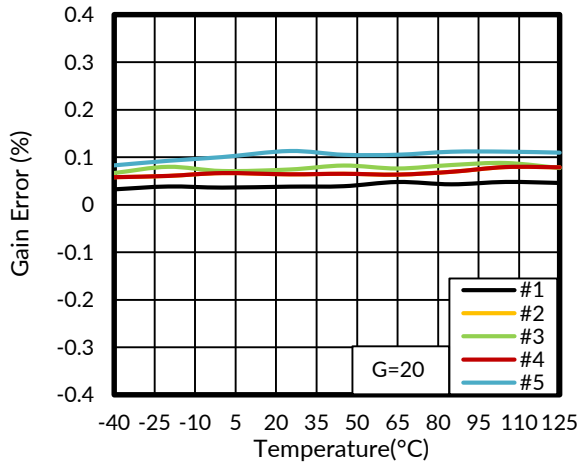

Figure 7. Gain Error vs Temperature

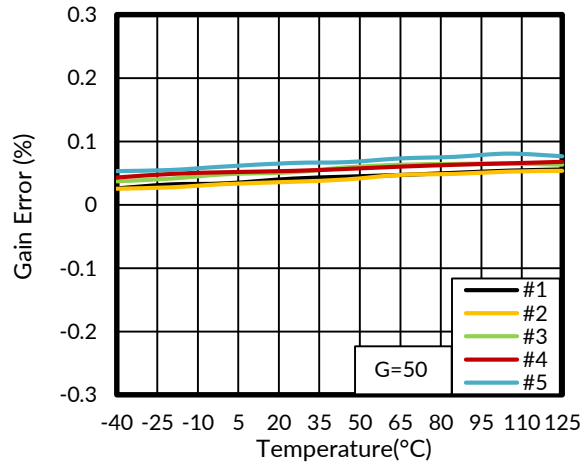

Figure 8. Gain Error vs Temperature

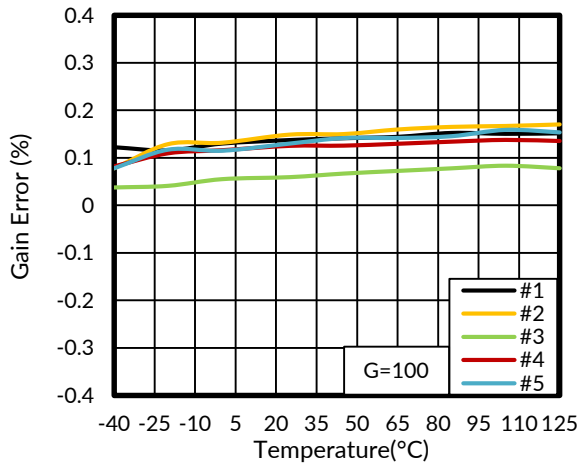

Figure 9. Gain Error vs Temperature

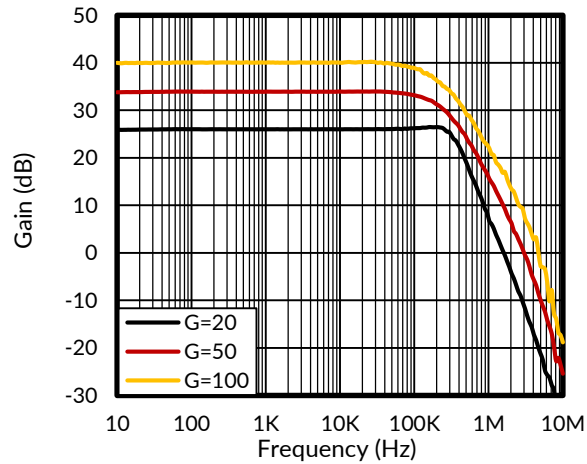

Figure 10. Gain vs Frequency

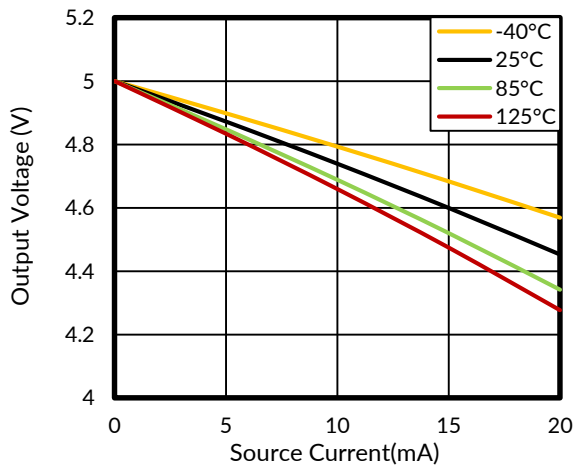

Figure 11. Output Voltage vs Source Current

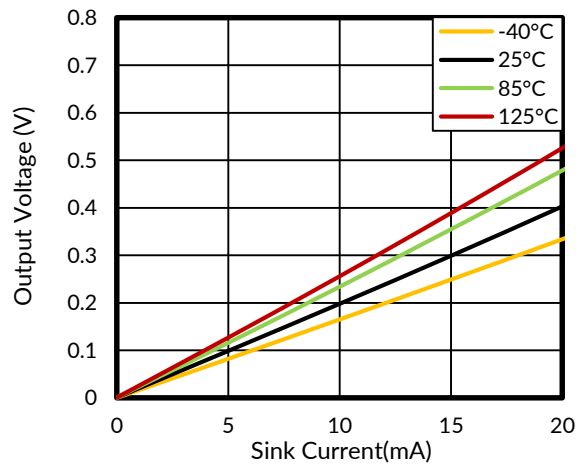

Figure 12. Output Voltage vs Sink Current

Typical Characteristics

NOTE: The graphs and tables provided following this note are a statistical summary based on a limited number of samples and are provided for informational purposes only.

At $T_A = +25^\circ\text{C}$, $V_S = 5\text{V}$, $R_L = 10\text{k}\Omega$, REF connected to $V_S/2$, $V_{OUT} = V_S/2$, unless otherwise noted.

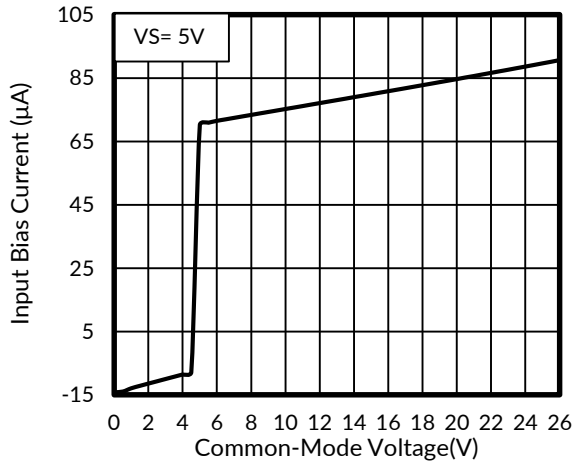

Figure 13. Input Bias Current vs Common-Mode Voltage

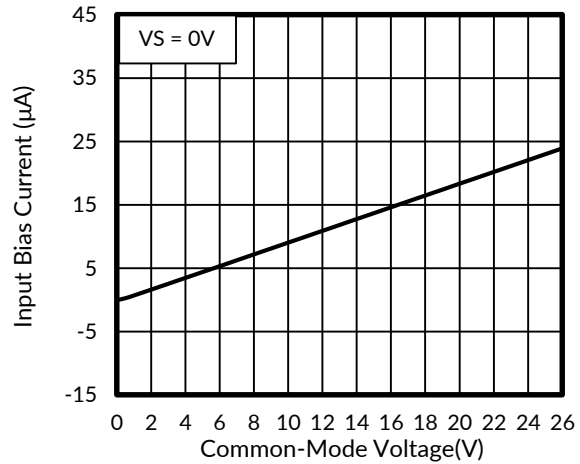

Figure 14. Input Bias Current vs Common-Mode Voltage (Both Inputs, Shutdown)

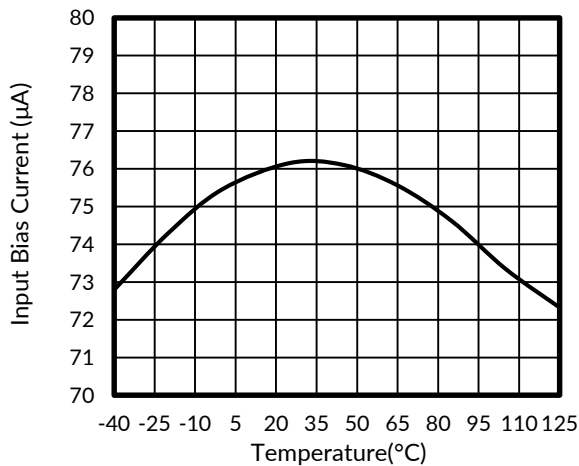

Figure 15. Input Bias Current vs Temperature

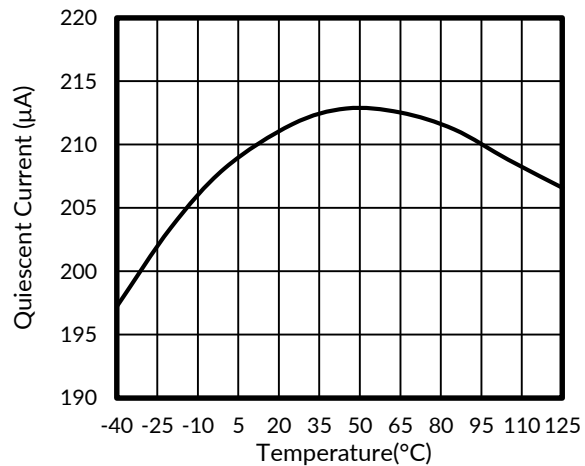

Figure 16. Quiescent Current vs Temperature

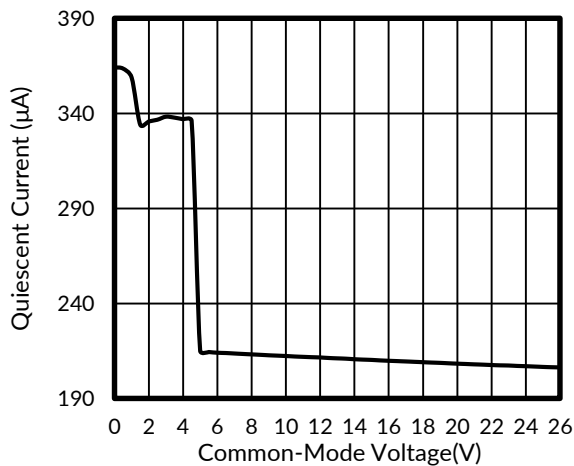

Figure 17. Quiescent Current vs Common-Mode Voltage

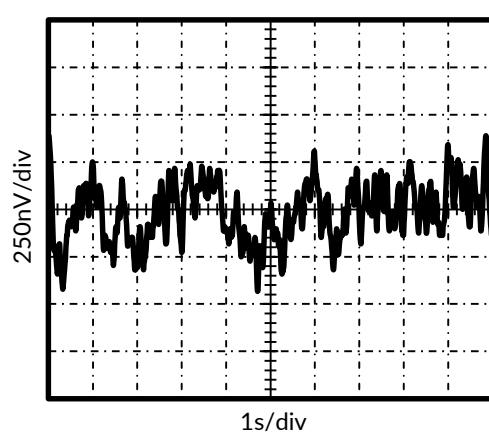

Figure 18. 0.1Hz to 10Hz Voltage Noise (Referred-to-Input)

Typical Characteristics

NOTE: The graphs and tables provided following this note are a statistical summary based on a limited number of samples and are provided for informational purposes only.

At $T_A = +25^\circ\text{C}$, $V_S = 5\text{V}$, $R_L = 10\text{k}\Omega$, REF connected to $V_S/2$, $V_{OUT} = V_S/2$, unless otherwise noted.

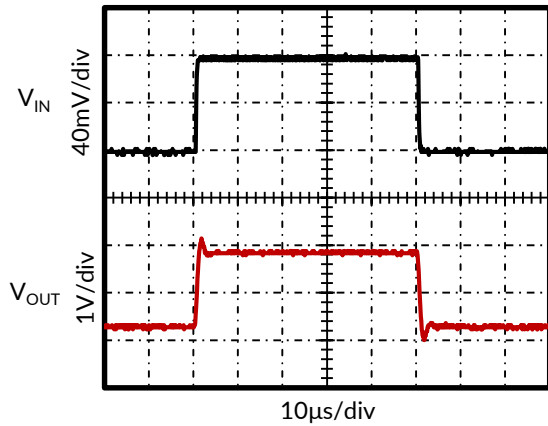

Figure 19. Step Response

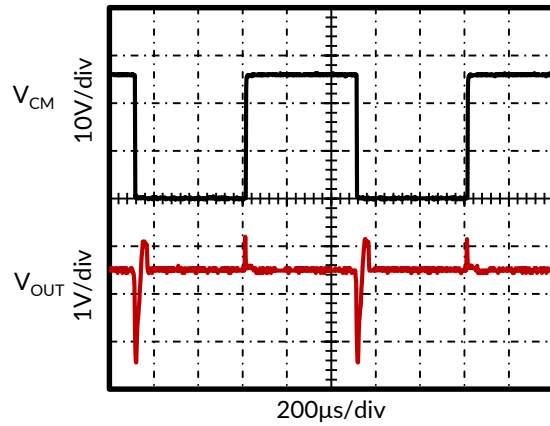

Figure 20. Common-Mode Voltage Transient Response

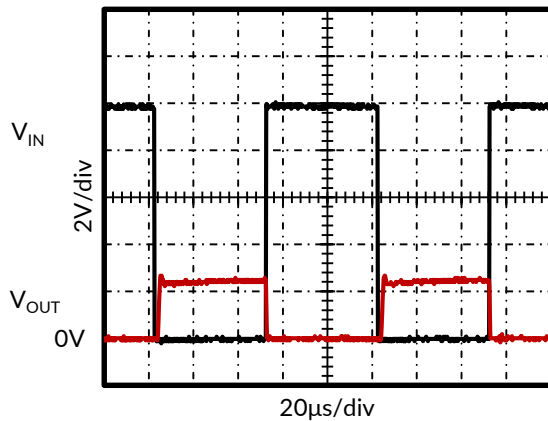

Figure 21. Inverting Differential Input Overload

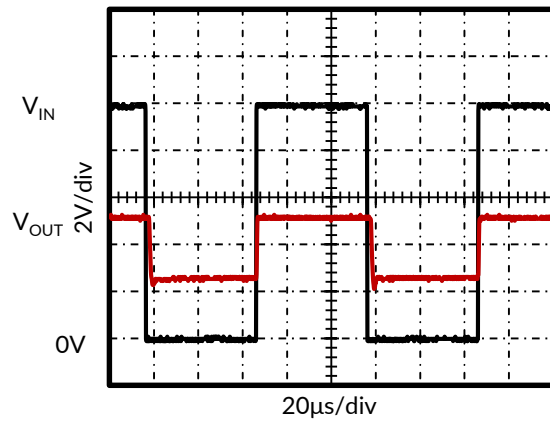

Figure 22. Noninverting Differential Input Overload

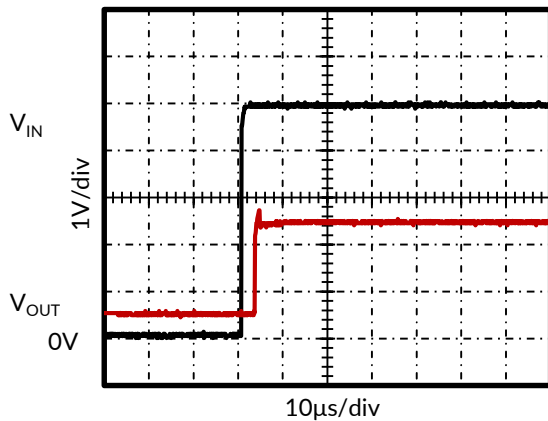

Figure 23. Start-Up Response

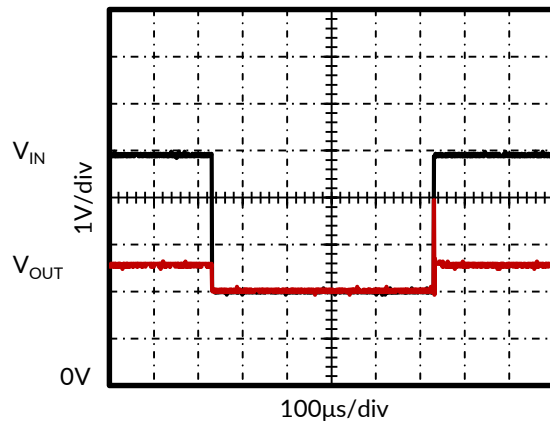

Figure 24. Brownout Recovery

9 APPLICATION INFORMATION

Information in the following applications sections is not part of the Runic component specification, and Runic does not warrant its accuracy or completeness. Runic's customers are responsible for determining suitability of components for their purposes. Customers should validate and test their design implementation to confirm system functionality.

9.1 Power Supply

The input circuit of the RS181 can accurately measure beyond its power supply voltage. For example, the VCC power supply can be 5V, whereas the load power supply voltage can be as high as 26V. The output voltage range of the OUT terminal is limited by the voltages on the power supply pin. Note also that the RS181 can withstand the full -0.1V to 26V range in the input pins, regardless of whether the device has power applied or not.

9.2 Selecting R_{SHUNT}

The RS181 series of current shunt monitors give high accuracy at a full-scale range on the order of 10mV. This accuracy reduces shunt dissipation by an order of magnitude with many additional benefits. Alternatively, there are applications that must measure current over a wide dynamic range that can take advantage of the low offset on the low end of the measurement. Most often, these applications can use gain of 20, 50 or 100 to accommodate larger shunt drops on the upper end of the scale.

9.3 Unidirectional Operation

Unidirectional operation allows the RS181 to measure currents through a resistive shunt in one direction. The most frequent case of unidirectional operation sets the output at ground by connecting the REF pin to ground. In unidirectional applications where the highest possible accuracy is desirable at very low inputs, bias the REF pin to a convenient value above 300mV to get the device output swing into the linear range for zero inputs.

A less frequent case of unipolar output biasing is to bias the output by connecting the REF pin to the supply; in this case, the quiescent output for zero input is at quiescent supply. This configuration would only respond to negative currents (inverted voltage polarity at the device input).

9.4 Shutting Down the RS181 Series

While the RS181 series do not have a shutdown pin, the low power consumption allows powering from the output of a logic gate or transistor switch that can turn on and turn off the RS181 power supply quiescent current.

However, in current shunt monitoring applications, there is also a concern for how much current is drained from the shunt circuit in shutdown conditions. Evaluating this current drain involves considering the simplified schematic of the RS181 in shutdown mode shown in Figure 25.

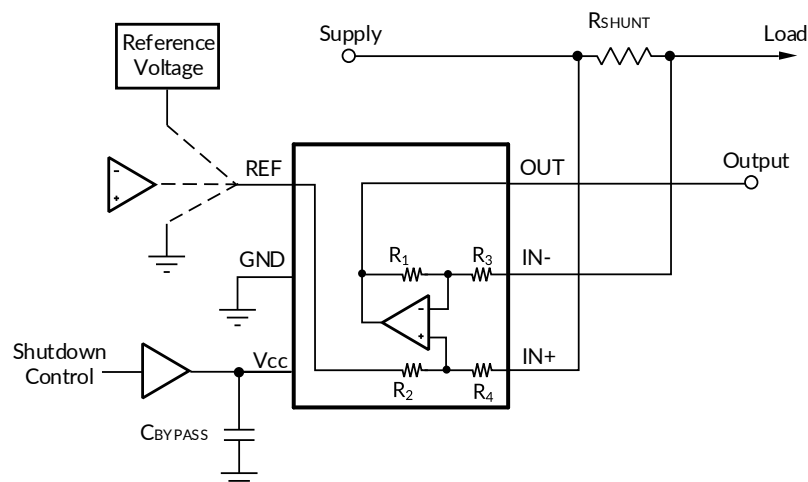

Figure 25. Basic Circuit for Shutting Down RS181 with Grounded Reference

9.5 REF Input Impedance Effects

As with any difference amplifier, the RS181 series common mode rejection ratio is affected by any impedance present at the REF input. This concern is not a problem when the REF pin is connected directly to most references or power supplies. When using resistive dividers from the power supply or a reference voltage, the REF pin should be buffered by an operational amplifier.

In systems where the RS181 output can be sensed differentially, such as by a differential input ADC or by using two separate ADC inputs, the effects of external impedance on the REF input can be cancelled. Figure 26 depicts a method of taking the output from the RS181 by using the REF pin as a reference.

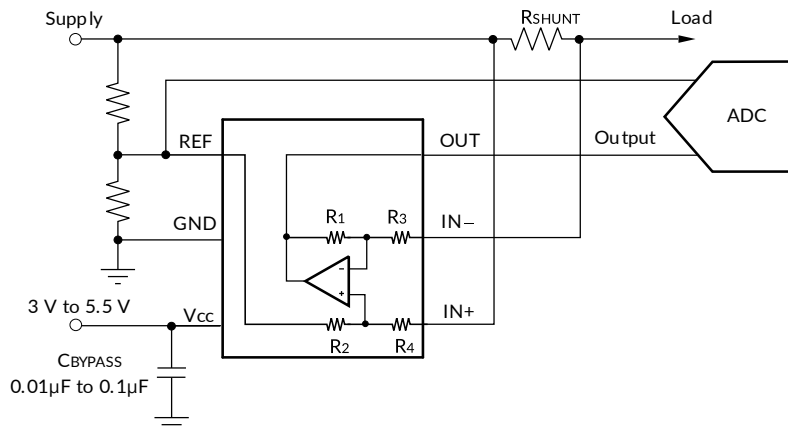

Figure 26. Sensing RS181 to cancel effects of impedance on the REF input

9.6 Using the RS181 with Common Mode Transients above 26V

With a small amount of additional circuitry, the RS181 series can be used in circuits subject to transients higher than 26V, such as automotive applications. Use only Zener diode or Zener-type transient absorbers (sometimes referred to as Transzorbs); any other type of transient absorber has an unacceptable time delay. Start by adding a pair of resistors as shown in Figure 27 as working impedance for the Zener. It is desirable to keep these resistors as small as possible, most often around 10 Ω . Larger values can be used with an effect on gain that is discussed in the section on input filtering.

Because this circuit limits only short-term transients, many applications are satisfied with a 10 Ω resistor along with conventional Zener diodes of the lowest power rating that can be found. This combination uses the least amount of board space.

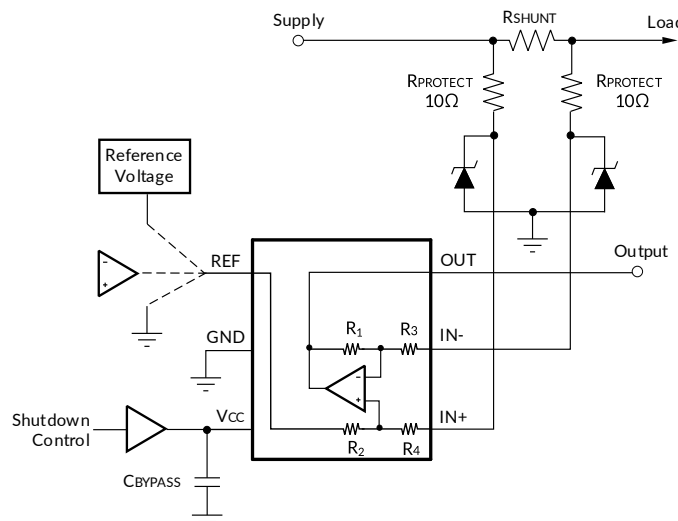
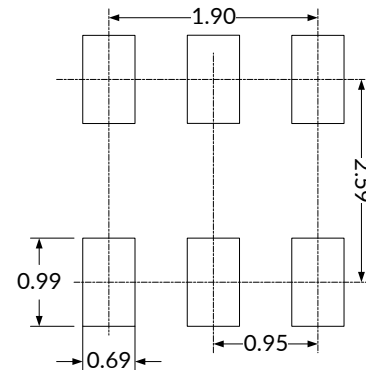
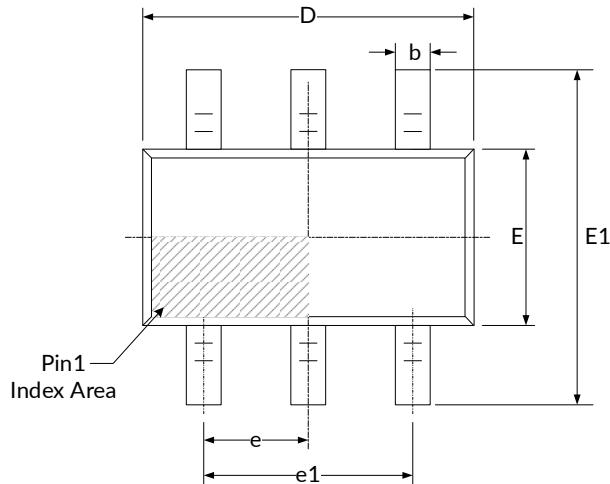
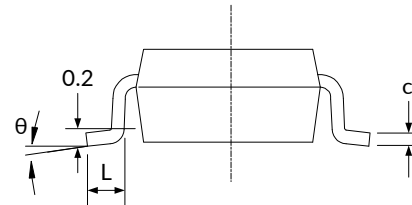
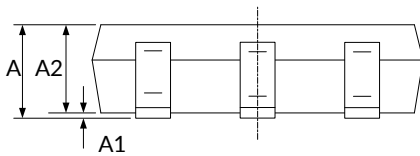

Figure 27. Transient Protection Using Dual Zener Diodes

10 PACKAGE OUTLINE DIMENSIONS

SOT23-6⁽³⁾

RECOMMENDED LAND PATTERN (Unit: mm)

| Symbol | Dimensions In Millimeters | | Dimensions In Inches | |
|------------------|---------------------------|-------|---------------------------|-------|
| | Min | Max | Min | Max |
| A ⁽¹⁾ | 1.050 | 1.250 | 0.041 | 0.049 |
| A1 | 0.000 | 0.100 | 0.000 | 0.004 |
| A2 | 1.050 | 1.150 | 0.041 | 0.045 |
| b | 0.300 | 0.500 | 0.012 | 0.020 |
| c | 0.100 | 0.200 | 0.004 | 0.008 |
| D ⁽¹⁾ | 2.820 | 3.020 | 0.111 | 0.119 |
| E ⁽¹⁾ | 1.500 | 1.700 | 0.059 | 0.067 |
| E1 | 2.650 | 2.950 | 0.104 | 0.116 |
| e | 0.950(BSC) ⁽²⁾ | | 0.037(BSC) ⁽²⁾ | |
| e1 | 1.800 | 2.000 | 0.071 | 0.079 |
| L | 0.300 | 0.600 | 0.012 | 0.024 |
| θ | 0° | 8° | 0° | 8° |

NOTE:

1. Plastic or metal protrusions of 0.15mm maximum per side are not included.
2. BSC (Basic Spacing between Centers), "Basic" spacing is nominal.
3. This drawing is subject to change without notice.

11 TAPE AND REEL INFORMATION

REEL DIMENSIONS

TAPE DIMENSION

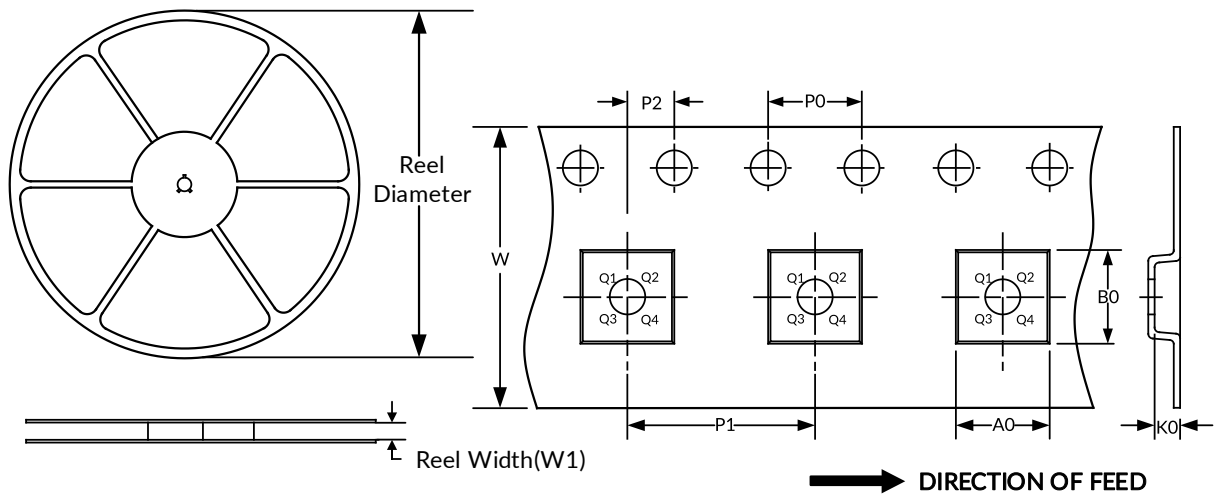

NOTE: The picture is only for reference. Please make the object as the standard.

KEY PARAMETER LIST OF TAPE AND REEL

| Package Type | Reel Diameter | Reel Width (mm) | A0 (mm) | B0 (mm) | K0 (mm) | P0 (mm) | P1 (mm) | P2 (mm) | W (mm) | Pin1 Quadrant |
|--------------|---------------|-----------------|---------|---------|---------|---------|---------|---------|--------|---------------|
| SOT23-6 | 7" | 9.5 | 3.17 | 3.23 | 1.37 | 4.0 | 4.0 | 2.0 | 8.0 | Q3 |

NOTE:

1. All dimensions are nominal.
2. Plastic or metal protrusions of 0.15mm maximum per side are not included.

IMPORTANT NOTICE AND DISCLAIMER

Jiangsu Runic Technology Co., Ltd. will accurately and reliably provide technical and reliability data (including data sheets), design resources (including reference designs), application or other design advice, WEB tools, safety information and other resources, without warranty of any defect, and will not make any express or implied warranty, including but not limited to the warranty of merchantability Implied warranty that it is suitable for a specific purpose or does not infringe the intellectual property rights of any third party.

These resources are intended for skilled developers designing with Runic products You will be solely responsible for: (1) Selecting the appropriate products for your application; (2) Designing, validating and testing your application; (3) Ensuring your application meets applicable standards and any other safety, security or other requirements; (4) Runic and the Runic logo are registered trademarks of Runic Incorporated. All trademarks are the property of their respective owners; (5) For change details, review the revision history included in any revised document. The resources are subject to change without notice. Our company will not be liable for the use of this product and the infringement of patents or third-party intellectual property rights due to its use.