

1.1MHz, Precision, Rail-to-Rail I/O CMOS Operational Amplifier

1 FEATURES

- **High Gain Bandwidth: 1.1MHz**
- **Rail-to-Rail Input and Output**
 $\pm 0.5\text{mV}$ Max Vos (RS6331P, RS6332P)
 $\pm 0.8\text{mV}$ Max Vos (RS6334P)
- **Input Voltage Range: -0.1V to +5.6V**
with $V_s = 5.5\text{V}$
- **Supply Range: +2.1V to +5.5V**
- **Specified Up to +125°C**
- **Micro Size Packages: SOT23-5, SC70-5**

2 APPLICATIONS

- **Sensors**
- **Photodiode Amplification**
- **Active Filters**
- **Test Equipment**
- **Driving A/D Converters**

3 DESCRIPTIONS

The RS6331P, RS6332P, RS6334P families of products offer low voltage operation and rail-to-rail input and output, as well as excellent speed/power consumption ratio, providing an excellent bandwidth (1.1MHz) and slew rate of $0.5\text{V}/\mu\text{s}$. The op-amps are unity gain stable and feature an ultra-low input bias current.

The RS6331P, RS6332P and RS6334P has lower offset, which is guaranteed not upper than $\pm 0.5\text{mV}$ (RS6331P, RS6332P) / $\pm 0.8\text{mV}$ (RS6334P) at 25°C with $V_s = 5\text{V}$, $V_{\text{CM}} = V_s/2$.

The devices are ideal for sensor interfaces, active filters and portable applications. The RS6331P, RS6332P, RS6334P families of operational amplifiers are specified at the full temperature range of -40°C to 125°C under single supplies of 2.1V to 5.5V or dual power supplies of $\pm 1.05\text{V}$ to $\pm 2.75\text{V}$.

Device Information⁽¹⁾

PART NUMBER	PACKAGE	BODY SIZE(NOM)
RS6331P	SOT23-5	2.90mm×1.60mm
	SC70-5	2.10mm×1.25mm
RS6332P	SOP8	4.90mm×3.90mm
	MSOP8	3.00mm×3.00mm
RS6334P	SOP14	8.65mm×3.90mm
	TSSOP14	5.00mm×4.40mm

(1) For all available packages, see the orderable addendum at the end of the data sheet.

Table of Contents

1 FEATURES	1
2 APPLICATIONS	1
3 DESCRIPTIONS	1
4 REVISION HISTORY	3
5 PACKAGE/ORDERING INFORMATION ⁽¹⁾	4
6 PIN CONFIGURATION AND FUNCTIONS	5
7 SPECIFICATIONS	7
7.1 Absolute Maximum Ratings	7
7.2 ESD Ratings	7
7.3 Recommended Operating Conditions	7
7.4 Electrical Characteristics	8
7.5 Typical Characteristics	10
8 DETAILED DESCRIPTION	13
8.1 Overview	13
8.2 Phase Reversal Protection	13
8.3 EMI Rejection Ratio (EMIRR)	13
8.4 EMIRR IN+ Test Configuration	14
9 APPLICATION AND IMPLEMENTATION	15
9.1 Application Notes	15
9.2 25-kHz Low-Pass Filter	15
9.3 Design Requirements	15
9.4 Detailed Design Procedure	15
9.5 Application Curve	16
10 LAYOUT	17
10.1 Layout Guidelines	17
10.2 Layout Example	17
11 PACKAGE OUTLINE DIMENSIONS	18
12 TAPE AND REEL INFORMATION	24

4 REVISION HISTORY

Note: Page numbers for previous revisions may differ from page numbers in the current version.

VERSION	Change Date	Change Item
C.2	2022/05/17	<ol style="list-style-type: none">1. Update specification layout2. Update Package Qty on Page 2 in RevC.13. Added TAPE AND REEL INFORMATION4. Added Detailed Description
C.2.1	2024/03/04	Modify packaging naming
C.3	2024/12/13	<ol style="list-style-type: none">1. Add MSL on Page 7 in RevC.2.12. Add Package thermal impedance on Page 5 in RevC.2.13. Update PACKAGE note4. Delete RS6331PXC5 and RS6332PXQ Orderable Device

5 PACKAGE/ORDERING INFORMATION ⁽¹⁾

Orderable Device	Package Type	Pin	Channel	Op Temp(°C)	Device Marking ⁽²⁾	MSL ⁽³⁾	Package Qty
RS6331PXF	SOT23-5	5	1	-40°C ~125°C	6331P	MSL3	Tape and Reel, 3000
RS6331BPXF	SOT23-5	5	1	-40°C ~125°C	6331BP	MSL3	Tape and Reel, 3000
RS6331BPXC5	SC70-5 ⁽⁴⁾	5	1	-40°C ~125°C	6331BP	MSL3	Tape and Reel, 3000
RS6332PXK	SOP8	8	2	-40°C ~125°C	RS6332P	MSL3	Tape and Reel, 4000
RS6332PXM	MSOP8	8	2	-40°C ~125°C	RS6332P	MSL3	Tape and Reel, 4000
RS6334PXP	SOP14	14	4	-40°C ~125°C	RS6334P	MSL3	Tape and Reel, 4000
RS6334PXQ	TSSOP14	14	4	-40°C ~125°C	RS6334P	MSL3	Tape and Reel, 4000

NOTE:

- (1) This information is the most current data available for the designated devices. This data is subject to change without notice and revision of this document. For browser-based versions of this data sheet, refer to the right-hand navigation.
- (2) There may be additional marking, which relates to the lot trace code information (data code and vendor code), the logo or the environmental category on the device.
- (3) RUNIC classify the MSL level with using the common preconditioning setting in our assembly factory conforming to the JEDEC industrial standard J-STD-20F. Please align with RUNIC if your end application is quite critical to the preconditioning setting or if you have special requirement.
- (4) Equivalent to SOT353.

6 PIN CONFIGURATION AND FUNCTIONS

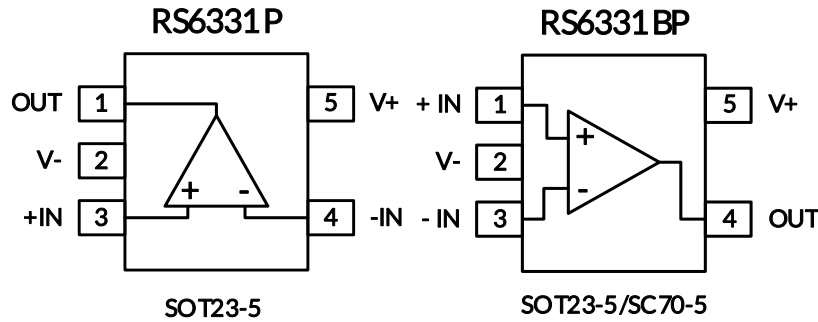

PIN DESCRIPTION

NAME	PIN		I/O ⁽¹⁾	DESCRIPTION
	RS6331P	RS6331BP		
	SOT23-5	SOT23-5/SC70-5		
-IN	4	3	I	Negative (inverting) input
+IN	3	1	I	Positive (noninverting) input
NC	-	-	-	No internal connection (can be left floating)
OUT	1	4	O	Output
V-	2	2	-	Negative (lowest) power supply
V+	5	5	-	Positive (highest) power supply

(1) I = Input, O = Output.

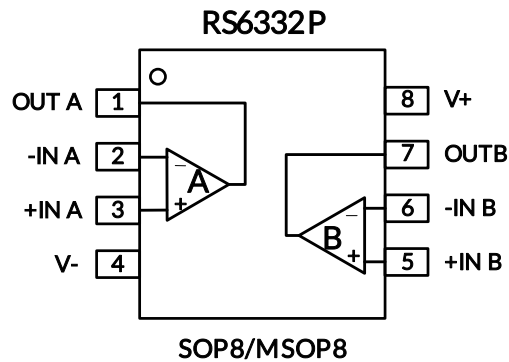

PIN DESCRIPTION

NAME	PIN	I/O ⁽¹⁾	DESCRIPTION
	SOP8/MSOP8		
-INA	2	I	Inverting input, channel A
+INA	3	I	Noninverting input, channel A
-INB	6	I	Inverting input, channel B
+INB	5	I	Noninverting input, channel B
OUTA	1	O	Output, channel A
OUTB	7	O	Output, channel B
V-	4	-	Negative (lowest) power supply
V+	8	-	Positive (highest) power supply

(1) I = Input, O = Output.

PIN CONFIGURATION AND FUNCTIONS

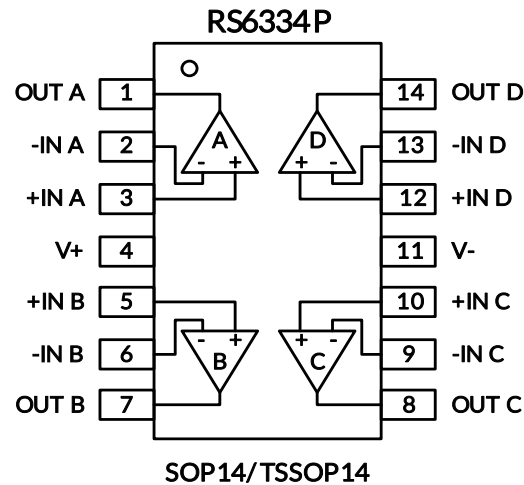

PIN DESCRIPTION

NAME	PIN	I/O ⁽¹⁾	DESCRIPTION
	SOP14/TSSOP14		
-INA	2	I	Inverting input, channel A
+INA	3	I	Noninverting input, channel A
-INB	6	I	Inverting input, channel B
+INB	5	I	Noninverting input, channel B
-INC	9	I	Inverting input, channel C
+INC	10	I	Noninverting input, channel C
-IND	13	I	Inverting input, channel D
+IND	12	I	Noninverting input, channel D
OUTA	1	O	Output, channel A
OUTB	7	O	Output, channel B
OUTC	8	O	Output, channel C
OUTD	14	O	Output, channel D
V-	11	-	Negative (lowest) power supply
V+	4	-	Positive (highest) power supply

(1) I = Input, O = Output.

7 SPECIFICATIONS

7.1 Absolute Maximum Ratings

Over operating free-air temperature range (unless otherwise noted) ⁽¹⁾

		MIN	MAX	UNIT	
Voltage	Supply, $V_S=(V+) - (V-)$		7	V	
	Signal input pin ⁽²⁾	(V-)-0.5	(V+) +0.5		
	Signal output pin ⁽³⁾	(V-)-0.5	(V+) +0.5		
Current	Signal input pin ⁽²⁾	-10	10	mA	
	Signal output pin ⁽³⁾	-140	140	mA	
	Output short-circuit ⁽⁴⁾	Continuous			
θ_{JA}	Package thermal impedance ⁽⁵⁾	SOT23-5		230	°C/W
		SOP8		110	
		MSOP8		170	
		SOP14		105	
		TSSOP14		90	
		SC70-5		380	
Temperature	Operating range, T_A	-40	125	°C	
	Junction, T_J ⁽⁶⁾	-40	150		
	Storage, T_{stg}	-65	150		

(1) Stresses above these ratings may cause permanent damage. Exposure to absolute maximum conditions for extended periods may degrade device reliability. These are stress ratings only, and functional operation of the device at these or any other conditions beyond those specified is not implied.

(2) Input terminals are diode-clamped to the power-supply rails. Input signals that can swing more than 0.5V beyond the supply rails should be current-limited to 10mA or less.

(3) Output terminals are diode-clamped to the power-supply rails. Output signals that can swing more than 0.5V beyond the supply rails should be current-limited to ± 140 mA or less.

(4) Short-circuit to ground, one amplifier per package.

(5) The package thermal impedance is calculated in accordance with JESD-51.

(6) The maximum power dissipation is a function of $T_{J(MAX)}$, $R_{\theta JA}$, and T_A . The maximum allowable power dissipation at any ambient temperature is $P_D = (T_{J(MAX)} - T_A) / R_{\theta JA}$. All numbers apply for packages soldered directly onto a PCB.

7.2 ESD Ratings

The following ESD information is provided for handling of ESD-sensitive devices in an ESD protected area only.

			VALUE	UNIT
$V_{(ESD)}$	Electrostatic discharge	Human-Body Model (HBM)	± 3000	V
		Machine Model (MM)	± 200	



ESD SENSITIVITY CAUTION

ESD damage can range from subtle performance degradation to complete device failure. Precision integrated circuits may be more susceptible to damage because very small parametric changes could cause the device not to meet its published specifications.

7.3 Recommended Operating Conditions

Over operating free-air temperature range (unless otherwise noted)

		MIN	NOM	MAX	UNIT
Supply voltage, $V_S=(V+) - (V-)$	Signal-supply	2.1		5.5	V
	Dual-supply	± 1.05		± 2.75	

7.4 Electrical Characteristics

(At $T_A = +25^\circ\text{C}$, $V_S = 5\text{V}$, $R_L = 10\text{k}\Omega$ connected to $V_S/2$, and $V_{OUT} = V_S/2$, Full ⁽⁹⁾ = -40°C to 125°C , unless otherwise noted.)⁽¹⁾

PARAMETER		CONDITIONS	T_J	RS6331P, RS6332P, RS6334P			
				MIN ⁽²⁾	TYP ⁽³⁾	MAX ⁽²⁾	UNIT
POWER SUPPLY							
V_S	Operating Voltage Range		25°C	2.1		5.5	V
I_Q	Quiescent Current Per Amplifier		25°C		85	145	μA
PSRR	Power-Supply Rejection Ratio	$V_S = 2.1\text{V to } 5.5\text{V}$, $V_{CM} = (V_-) + 0.5\text{V}$	25°C	75	92		dB
			Full	65			
t_{ON}	Turn-on time	$V_S = 5\text{V}$			20		μs
INPUT							
V_{OS}	Input Offset Voltage	RS6331P	25°C	-0.5	± 0.2	0.5	mV
		RS6332P	25°C	-0.5	± 0.2	0.5	
		RS6334P	25°C	-0.8	± 0.3	0.8	
$V_{OS}T_c$	Input Offset Voltage Average Drift		Full		± 2		$\mu\text{V}/^\circ\text{C}$
I_B	Input Bias Current ^{(4) (5)}		25°C		± 10	± 50	pA
I_{OS}	Input Offset Current ⁽⁴⁾		25°C		± 10	± 50	pA
V_{CM}	Common-Mode Voltage Range	$V_S = 5.5\text{V}$	25°C	-0.1		5.6	V
CMRR	Common-Mode Rejection Ratio	$V_S = 5.5\text{V}$, $V_{CM} = -0.1\text{V to } 4\text{V}$	25°C	75	95		dB
			Full	68			
		$V_S = 5.5\text{V}$, $V_{CM} = -0.1\text{V to } 5.6\text{V}$	25°C	63	85		
			Full	57			
OUTPUT							
A_{OL}	Open-Loop Voltage Gain	$R_L = 2\text{k}\Omega$, $V_O = 0.15\text{V to } 4.85\text{V}$	25°C	95	110		dB
			Full	85			
		$R_L = 10\text{k}\Omega$, $V_O = 0.05\text{V to } 4.95\text{V}$	25°C	100	120		
			Full	92			
	Output Swing From Rail	$R_L = 2\text{k}\Omega$	25°C		25		mV
		$R_L = 10\text{k}\Omega$			8		
I_{OUT}	Output Current Source ^{(6) (7)}		25°C		120		mA
FREQUENCY RESPONSE							
SR	Slew Rate ⁽⁸⁾		25°C		0.5		$\text{V}/\mu\text{s}$
GBP	Gain-Bandwidth Product		25°C		1.1		MHz
PM	Phase Margin		25°C		64		$^\circ$
t_s	Settling Time, 0.1%				1.3		μs
	Overload Recovery Time	$V_{IN} \text{ Gain} \geq V_S$			4.7		μs
NOISE							
e_n	Input Voltage Noise Density	$f = 1\text{KHz}$	25°C		22		$\text{nV}/\sqrt{\text{Hz}}$
		$f = 10\text{KHz}$	25°C		20		$\text{nV}/\sqrt{\text{Hz}}$

NOTE:

- (1) Electrical table values apply only for factory testing conditions at the temperature indicated. Factory testing conditions result in very limited self-heating of the device.
- (2) Limits are 100% production tested at 25°C. Limits over the operating temperature range are ensured through correlations using statistical quality control (SQC) method.
- (3) Typical values represent the most likely parametric norm as determined at the time of characterization. Actual typical values may vary over time and will also depend on the application and configuration.
- (4) This parameter is ensured by design and/or characterization and is not tested in production.
- (5) Positive current corresponds to current flowing into the device.
- (6) The maximum power dissipation is a function of $T_{J(MAX)}$, $R_{\theta JA}$, and T_A . The maximum allowable power dissipation at any ambient temperature is $P_D = (T_{J(MAX)} - T_A) / R_{\theta JA}$. All numbers apply for packages soldered directly onto a PCB.
- (7) Short circuit test is a momentary test.
- (8) Number specified is the slower of positive and negative slew rates.
- (9) Specified by characterization only.

7.5 Typical Characteristics

NOTE: The graphs and tables provided following this note are a statistical summary based on a limited number of samples and are provided for informational purposes only.

At $T_A = +25^\circ\text{C}$, $V_S = 5\text{V}$, $R_L = 10\text{k}\Omega$ connected to $V_S/2$, $V_{OUT} = V_S/2$, unless otherwise noted.

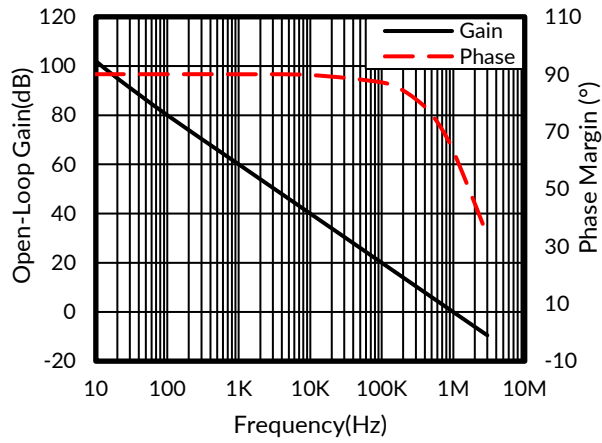

Figure 1. Open-Loop Gain and Phase vs Frequency

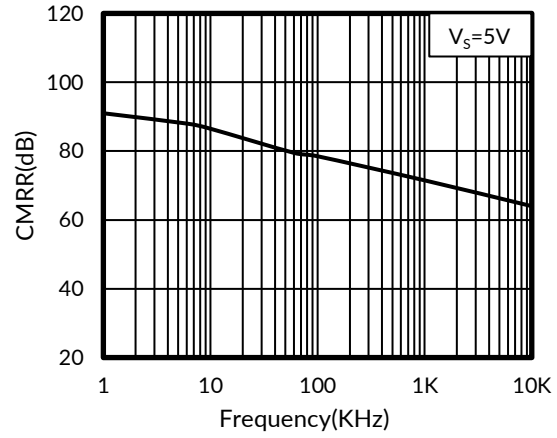

Figure 2. Common-Mode Rejection Ratio vs Frequency

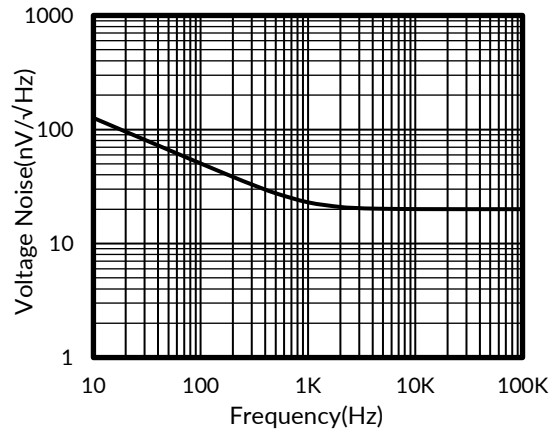

Figure 3. Input Voltage Noise Spectral Density vs Frequency

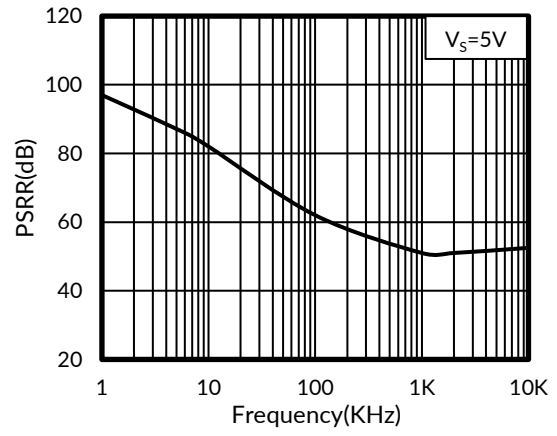

Figure 4. Power-Supply Rejection Ratio vs Frequency

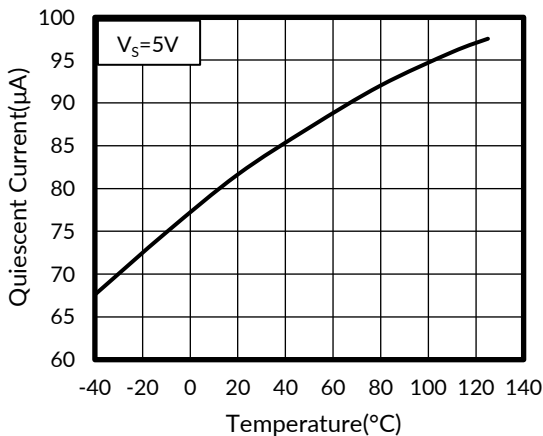

Figure 5. Quiescent Current vs Temperature

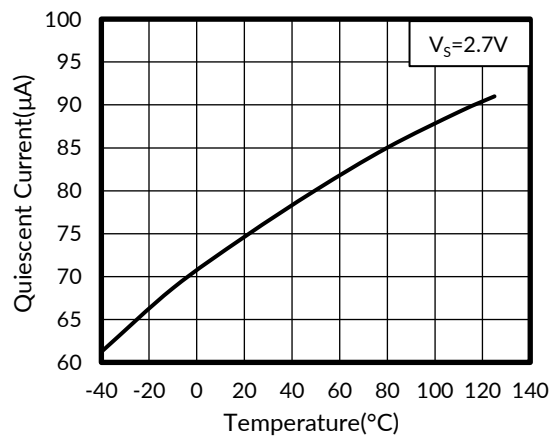

Figure 6. Quiescent Current vs Temperature

Typical Characteristics

NOTE: The graphs and tables provided following this note are a statistical summary based on a limited number of samples and are provided for informational purposes only.

At $T_A = +25^\circ\text{C}$, $V_S = 5\text{V}$, $R_L = 10\text{k}\Omega$ connected to $V_S/2$, $V_{OUT} = V_S/2$, unless otherwise noted.

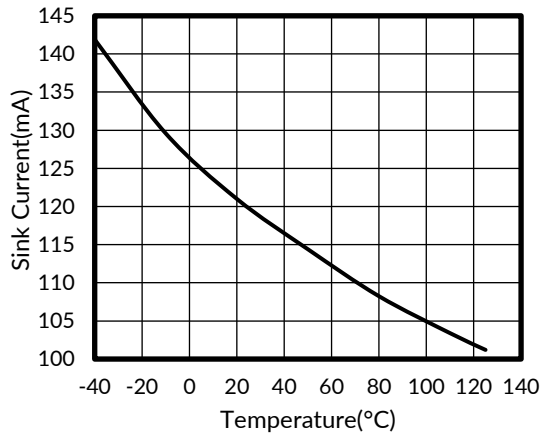

Figure 7. Sink Current vs Temperature

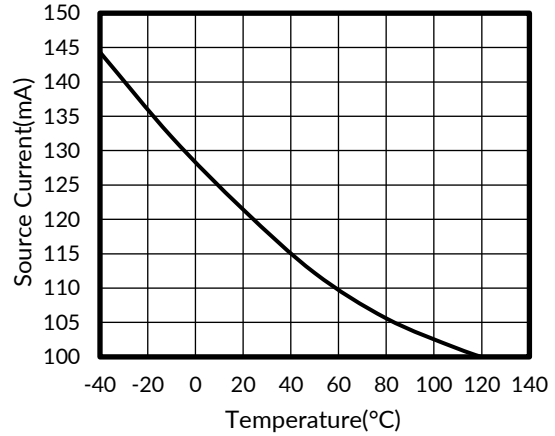

Figure 8. Source Current vs Temperature

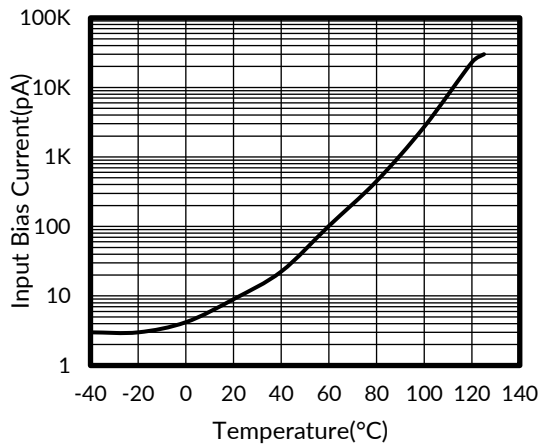

Figure 9. Input Bias Current vs Temperature

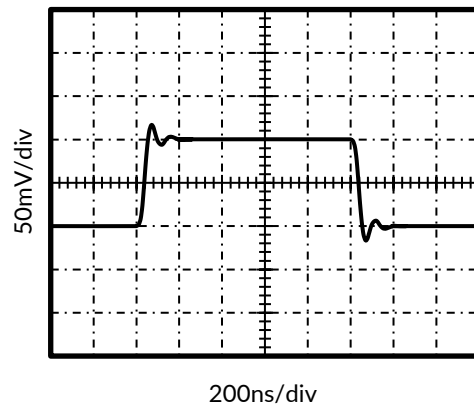

Figure 10. Small-Signal Step Response

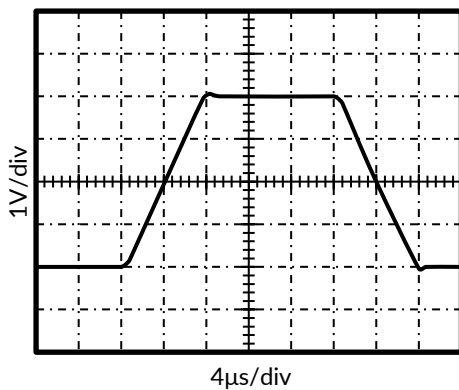

Figure 11. Large-Signal Step Response

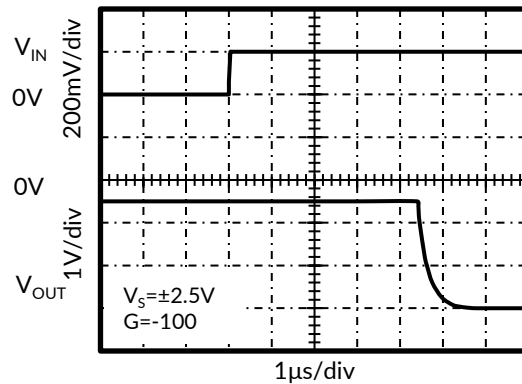

Figure 12. Positive Overvoltage Recovery

Typical Characteristics

NOTE: The graphs and tables provided following this note are a statistical summary based on a limited number of samples and are provided for informational purposes only.

At $T_A = +25^\circ\text{C}$, $V_S = 5\text{V}$, $R_L = 10\text{k}\Omega$ connected to $V_S/2$, $V_{OUT} = V_S/2$, unless otherwise noted.

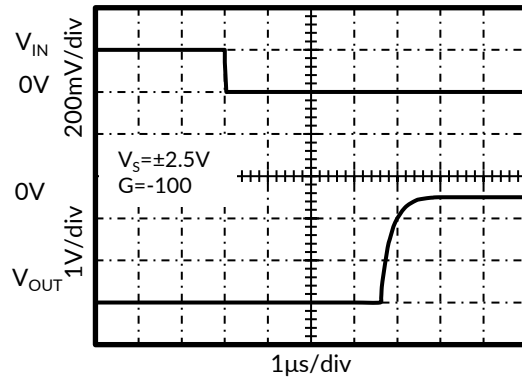

Figure 13. Negative Overvoltage Recovery

8 DETAILED DESCRIPTION

8.1 Overview

The RS633XP devices are unity-gain stable, dual and quad-channel op amps with low noise and distortion. The device consists of a low noise input stage with a folded cascade and a rail-to-rail output stage. This topology exhibits superior noise and distortion performance across a wide range of supply voltages that are not delivered by legacy commodity audio operational amplifiers.

8.2 Phase Reversal Protection

The RS633XP family has internal phase-reversal protection. Many op amps exhibit phase reversal when the input is driven beyond the linear common-mode range. This condition is most often encountered in noninverting circuits when the input is driven beyond the specified common-mode voltage range, causing the output to reverse into the opposite rail. The input of the RS633XP prevents phase reversal with excessive common-mode voltage. Instead, the appropriate rail limits the output voltage. This performance is shown in figure 14.

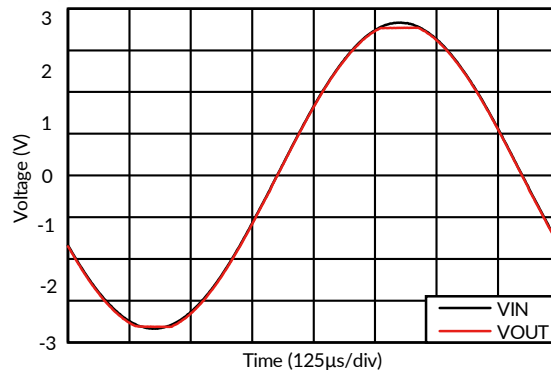

Figure 14. Output Waveform Devoid of Phase Reversal During an Input Overdrive Condition

8.3 EMI Rejection Ratio (EMIRR)

The electromagnetic interference (EMI) rejection ratio, or EMIRR, describes the EMI immunity of operational amplifiers. An adverse effect that is common to many operational amplifiers is a change in the offset voltage as a result of RF signal rectification. An operational amplifier that is more efficient at rejecting this change in offset as a result of EMI has a higher EMIRR and is quantified by a decibel value. Measuring EMIRR can be performed in many ways, but this document provides the EMIRR IN+, which specifically describes the EMIRR performance when the RF signal is applied to the noninverting input pin of the operational amplifier. In general, only the noninverting input is tested for EMIRR for the following three reasons:

- Operational amplifier input pins are known to be the most sensitive to EMI, and typically rectify RF signals better than the supply or output pins.
- The noninverting and inverting operational amplifier inputs have symmetrical physical layouts and exhibit nearly matching EMIRR performance.
- EMIRR is easier to measure on noninverting pins than on other pins because the noninverting input pin can be isolated on a printed-circuit-board (PCB). This isolation allows the RF signal to be applied directly to the noninverting input pin with no complex interactions from other components or connecting PCB traces.

DETAILED DESCRIPTION (continued)

The EMIRR IN+ of the RS633XP is plotted versus frequency in Figure 15. If available, any dual and quad operational amplifier device versions have approximately identical EMIRR IN+ performance. The RS633XP unity-gain bandwidth is 1.1MHz. EMIRR performance below this frequency denotes interfering signals that fall within the operational amplifier bandwidth.

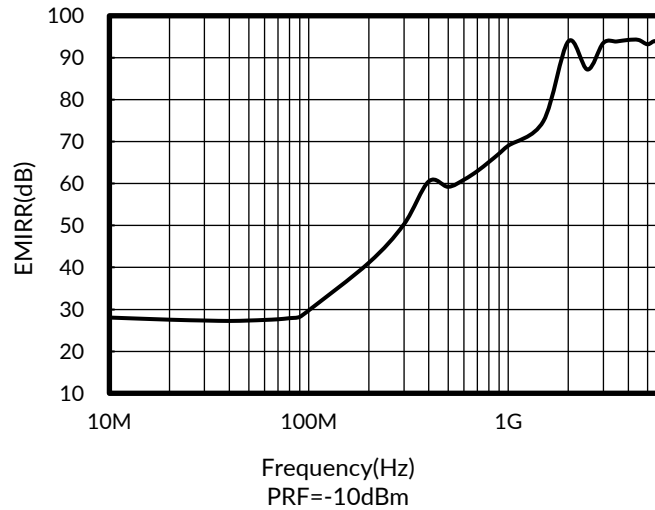

Figure 15. RS633XP EMIRR vs Frequency

8.4 EMIRR IN+ Test Configuration

Figure 16 shows the circuit configuration for testing the EMIRR IN+. An RF source is connected to the operational amplifier noninverting input pin using a transmission line. The operational amplifier is configured in a unity-gain buffer topology with the output connected to a low-pass filter (LPF) and a digital multimeter (DMM). A large impedance mismatch at the operational amplifier input causes a voltage reflection; however, this effect is characterized and accounted for when determining the EMIRR IN+. The resulting dc offset voltage is sampled and measured by the multimeter. The LPF isolates the multimeter from residual RF signals that can interfere with multimeter accuracy.

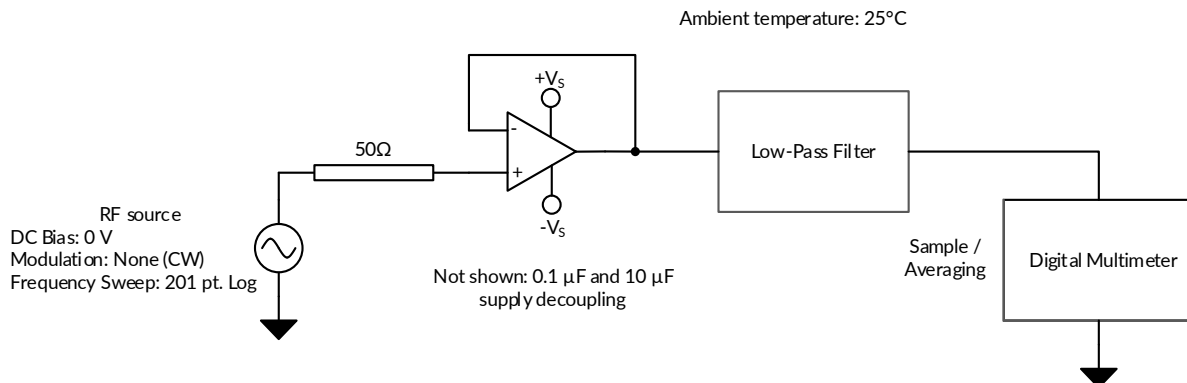

Figure 16. EMIRR IN+ Test Configuration Schematic

9 APPLICATION AND IMPLEMENTATION

Information in the following applications sections is not part of the Runic component specification, and Runic does not warrant its accuracy or completeness. Runic's customers are responsible for determining suitability of components for their purposes. Customers should validate and test their design implementation to confirm system functionality.

9.1 Application Notes

The RS6331P, RS6332P, RS6334P are high precision, rail-to-rail operational amplifiers that can be run from a single-supply voltage 2.1V to 5.5V ($\pm 1.05V$ to $\pm 2.75V$). Supply voltages higher than 7V (absolute maximum) can permanently damage the amplifier. Rail-to-rail input and output swing significantly increases dynamic range, especially in low-supply applications. Good layout practice mandates use of a 0.1 μ F capacitor place closely across the supply pins.

Typical Applications

9.2 25-kHz Low-Pass Filter

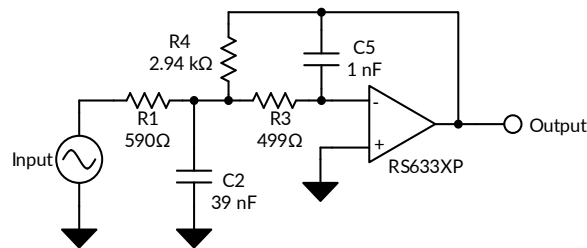

Figure 17. 25-kHz Low-Pass Filter

9.3 Design Requirements

Low-pass filters are commonly employed in signal processing applications to reduce noise and prevent aliasing. The RS633XP devices are ideally suited to construct high-speed, high-precision active filters. Figure 17 shows a second-order, low-pass filter commonly encountered in signal processing applications.

Use the following parameters for this design example:

- Gain = 5 V/V (inverting gain)
- Low-pass cutoff frequency = 25 kHz
- Second-order Chebyshev filter response with 3-dB gain peaking in the passband

9.4 Detailed Design Procedure

The infinite-gain multiple-feedback circuit for a low-pass network function is shown in Figure 17. Use Equation 1 to calculate the voltage transfer function.

$$\frac{\text{Output}}{\text{Input}}(s) = \frac{-1/R_1 R_3 C_2 C_5}{s^2 + (s/C_2) + (1/R_1 + 1/R_3 + 1/R_4) + 1/R_3 R_4 C_2 C_5} \quad (1)$$

This circuit produces a signal inversion. For this circuit, the gain at dc and the low-pass cutoff frequency are calculated by Equation 2:

$$\text{Gain} = \frac{R_4}{R_1}$$

$$f_c = \frac{1}{2\pi} \sqrt{(1/R_3 R_4 C_2 C_5)} \quad (2)$$

9.5 Application Curve

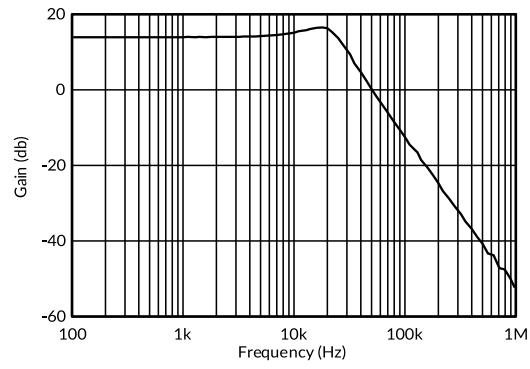

Figure 18. Low Pass Filter Transfer Function

10 LAYOUT

10.1 Layout Guidelines

Attention to good layout practices is always recommended. Keep traces short. When possible, use a PCB ground plane with surface-mount components placed as close to the device pins as possible. Place a $0.1\mu\text{F}$ capacitor closely across the supply pins.

These guidelines should be applied throughout the analog circuit to improve performance and provide benefits such as reducing the EMI susceptibility.

10.2 Layout Example

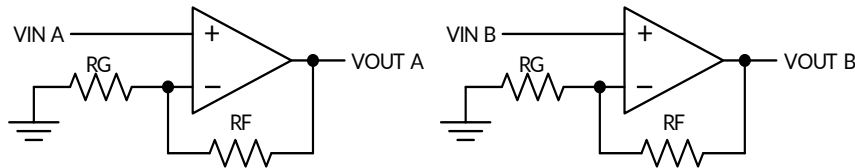

Figure 19. Schematic Representation

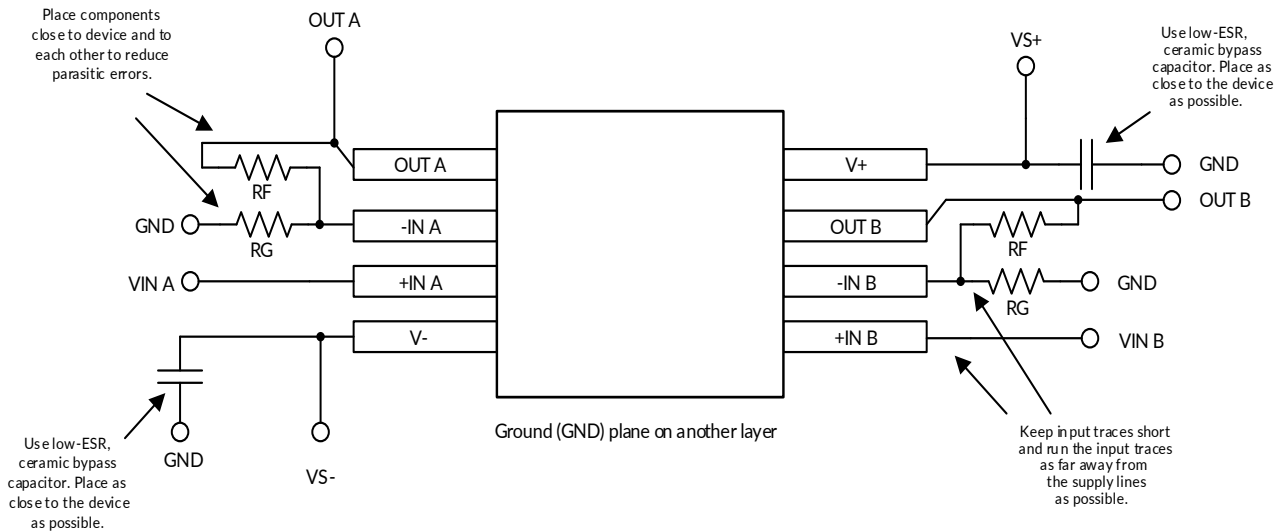
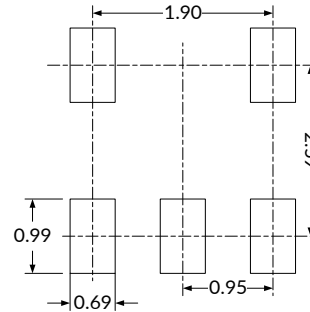
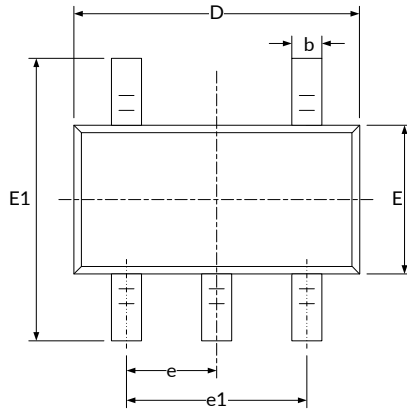

Figure 20. Layout Example

NOTE: Layout Recommendations have been shown for dual op-amp only, follow similar precautions for Single and four.

11 PACKAGE OUTLINE DIMENSIONS

SOT23-5⁽³⁾



RECOMMENDED LAND PATTERN (Unit: mm)

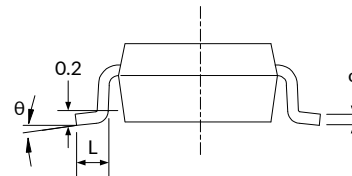
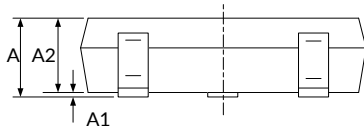

Symbol	Dimensions In Millimeters		Dimensions In Inches	
	Min	Max	Min	Max
A ⁽¹⁾	1.050	1.250	0.041	0.049
A1	0.000	0.100	0.000	0.004
A2	1.050	1.150	0.041	0.045
b	0.300	0.500	0.012	0.020
c	0.100	0.200	0.004	0.008
D ⁽¹⁾	2.820	3.020	0.111	0.119
E ⁽¹⁾	1.500	1.700	0.059	0.067
E1	2.650	2.950	0.104	0.116
e	0.950(BSC) ⁽²⁾		0.037(BSC) ⁽²⁾	
e1	1.800	2.000	0.071	0.079
L	0.300	0.600	0.012	0.024
θ	0°	8°	0°	8°

NOTE:

1. Plastic or metal protrusions of 0.15mm maximum per side are not included.
2. BSC (Basic Spacing between Centers), "Basic" spacing is nominal.
3. This drawing is subject to change without notice.

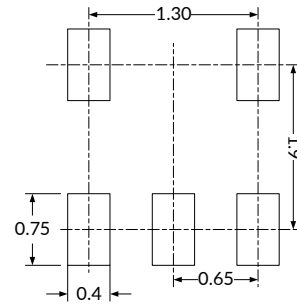
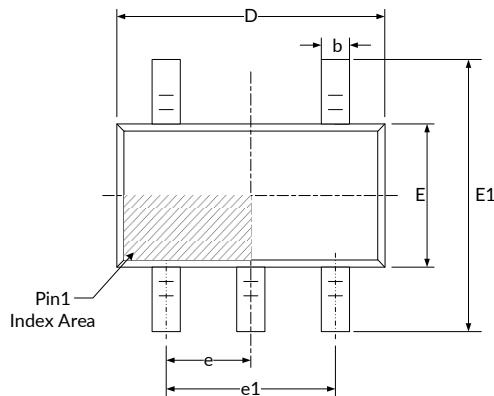
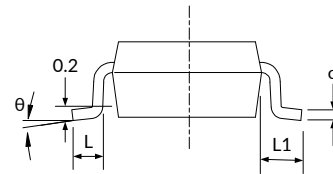
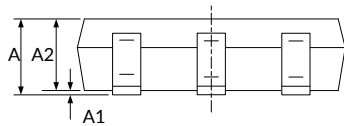
SC70-5 (3)

RECOMMENDED LAND PATTERN (Unit: mm)

Symbol	Dimensions In Millimeters		Dimensions In Inches	
	Min	Max	Min	Max
A ⁽¹⁾	0.900	1.100	0.035	0.043
A1	0.000	0.100	0.000	0.004
A2	0.900	1.000	0.035	0.039
b	0.150	0.350	0.006	0.014
c	0.080	0.150	0.003	0.006
D ⁽¹⁾	2.000	2.200	0.079	0.087
E ⁽¹⁾	1.150	1.350	0.045	0.053
E1	2.150	2.450	0.085	0.096
e	0.650(BSC) ⁽²⁾		0.026(BSC) ⁽²⁾	
e1	1.300(BSC) ⁽²⁾		0.051(BSC) ⁽²⁾	
L	0.260	0.460	0.010	0.018
L1	0.525		0.021	
θ	0°	8°	0°	8°

NOTE:

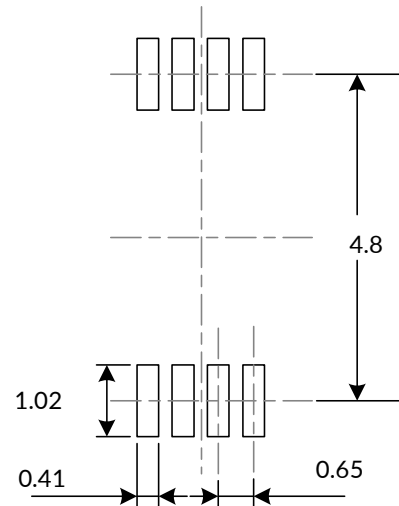
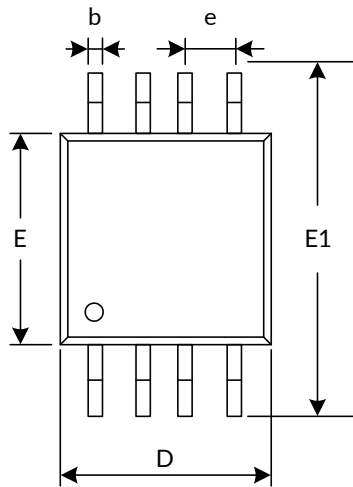
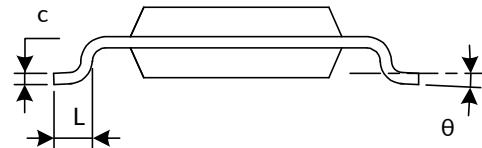
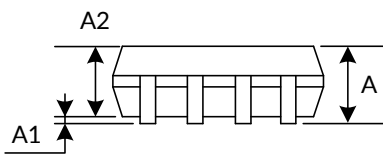
1. Plastic or metal protrusions of 0.15mm maximum per side are not included.
2. BSC (Basic Spacing between Centers), "Basic" spacing is nominal.
3. This drawing is subject to change without notice.

MSOP8⁽³⁾

RECOMMENDED LAND PATTERN (Unit: mm)

Symbol	Dimensions In Millimeters		Dimensions In Inches	
	Min	Max	Min	Max
A ⁽¹⁾	0.820	1.100	0.032	0.043
A1	0.020	0.150	0.001	0.006
A2	0.750	0.950	0.030	0.037
b	0.250	0.380	0.010	0.015
c	0.090	0.230	0.004	0.009
D ⁽¹⁾	2.900	3.100	0.114	0.122
e	0.650(BSC) ⁽²⁾		0.026(BSC) ⁽²⁾	
E ⁽¹⁾	2.900	3.100	0.114	0.122
E1	4.750	5.050	0.187	0.199
L	0.400	0.800	0.016	0.031
θ	0°	6°	0°	6°

NOTE:

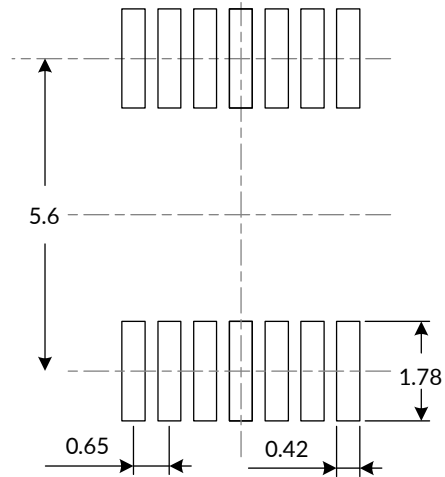
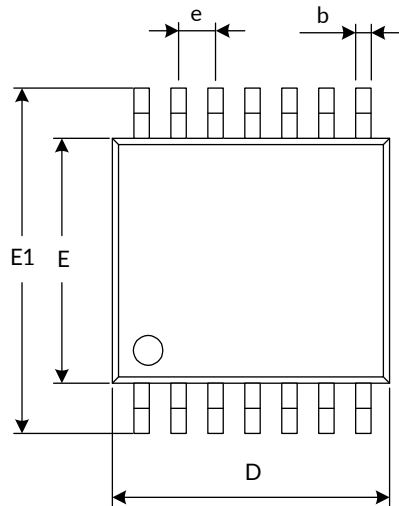
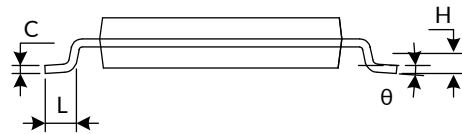
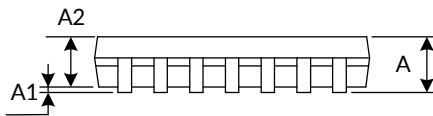
1. Plastic or metal protrusions of 0.15mm maximum per side are not included.
2. BSC (Basic Spacing between Centers), "Basic" spacing is nominal.
3. This drawing is subject to change without notice.

TSSOP14 (3)

RECOMMENDED LAND PATTERN (Unit: mm)

Symbol	Dimensions In Millimeters		Dimensions In Inches	
	Min	Max	Min	Max
A ⁽¹⁾		1.200		0.047
A1	0.050	0.150	0.002	0.006
A2	0.800	1.050	0.031	0.041
b	0.190	0.300	0.007	0.012
c	0.090	0.200	0.004	0.008
D ⁽¹⁾	4.860	5.100	0.191	0.201
E ⁽¹⁾	4.300	4.500	0.169	0.177
E1	6.250	6.550	0.246	0.258
e	0.650(BSC) ⁽²⁾		0.026(BSC) ⁽²⁾	
L	0.500	0.700	0.020	0.028
H	0.250(TYP)		0.010(TYP)	
θ	1°	7°	1°	7°

NOTE:

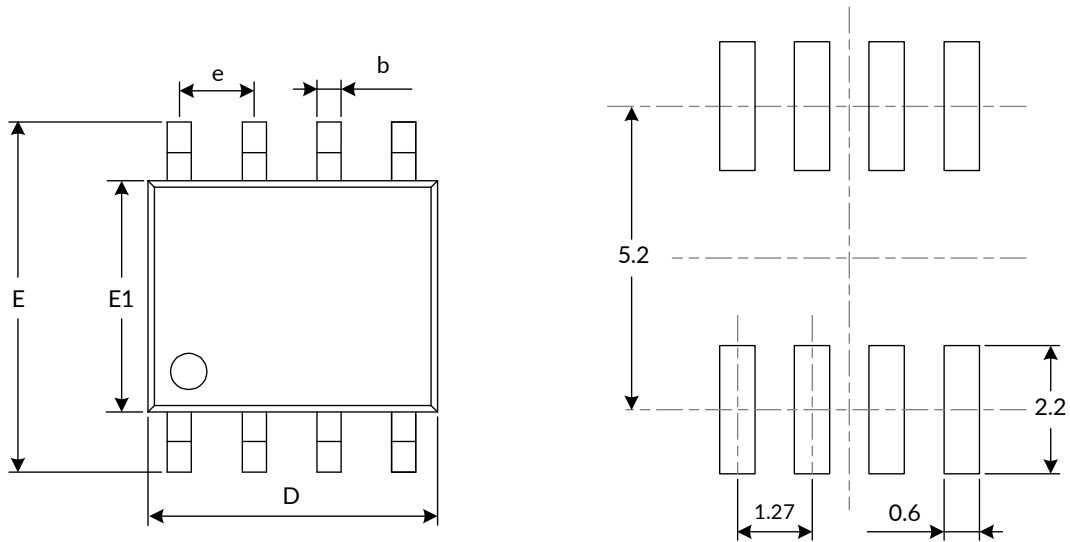
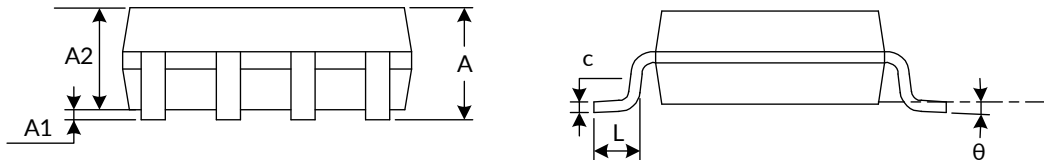
1. Plastic or metal protrusions of 0.15mm maximum per side are not included.
2. BSC (Basic Spacing between Centers), "Basic" spacing is nominal.
3. This drawing is subject to change without notice.

SOP8⁽³⁾

RECOMMENDED LAND PATTERN (Unit: mm)

Symbol	Dimensions In Millimeters		Dimensions In Inches	
	Min	Max	Min	Max
A ⁽¹⁾	1.350	1.750	0.053	0.069
A1	0.100	0.250	0.004	0.010
A2	1.350	1.550	0.053	0.061
b	0.330	0.510	0.013	0.020
c	0.170	0.250	0.007	0.010
D ⁽¹⁾	4.800	5.000	0.189	0.197
e	1.270(BSC) ⁽²⁾		0.050(BSC) ⁽²⁾	
E	5.800	6.200	0.228	0.244
E1 ⁽¹⁾	3.800	4.000	0.150	0.157
L	0.400	1.270	0.016	0.050
θ	0°	8°	0°	8°

NOTE:

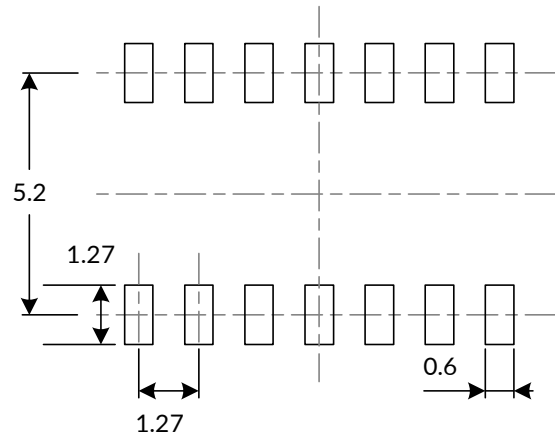
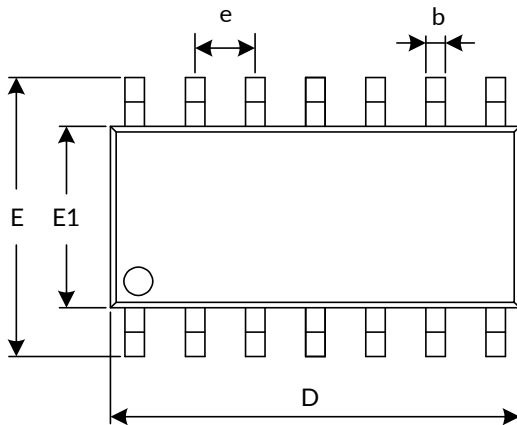
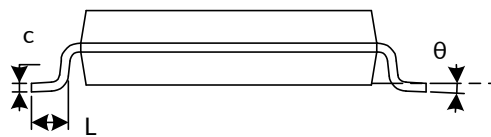
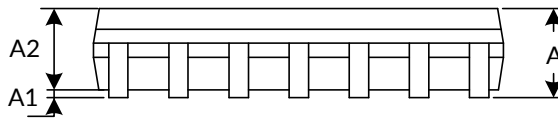
1. Plastic or metal protrusions of 0.15mm maximum per side are not included.
2. BSC (Basic Spacing between Centers), "Basic" spacing is nominal.
3. This drawing is subject to change without notice.

SOP14 (3)

RECOMMENDED LAND PATTERN (Unit: mm)

Symbol	Dimensions In Millimeters		Dimensions In Inches	
	Min	Max	Min	Max
A ⁽¹⁾	1.350	1.750	0.053	0.069
A1	0.100	0.250	0.004	0.010
A2	1.350	1.550	0.053	0.061
b	0.310	0.510	0.012	0.020
c	0.100	0.250	0.004	0.010
D ⁽¹⁾	8.450	8.850	0.333	0.348
e	1.270(BSC) ⁽²⁾		0.050(BSC) ⁽²⁾	
E	5.800	6.200	0.228	0.244
E1 ⁽¹⁾	3.800	4.000	0.150	0.157
L	0.400	1.270	0.016	0.050
θ	0°	8°	0°	8°

NOTE:

1. Plastic or metal protrusions of 0.15mm maximum per side are not included.
2. BSC (Basic Spacing between Centers), "Basic" spacing is nominal.
3. This drawing is subject to change without notice.

12 TAPE AND REEL INFORMATION

REEL DIMENSIONS

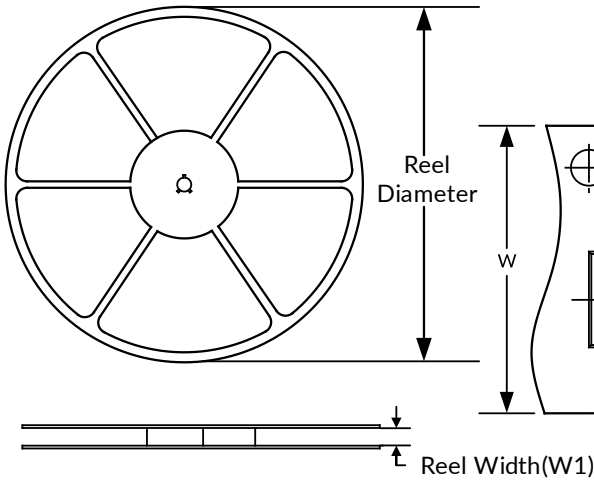

TAPE DIMENSION

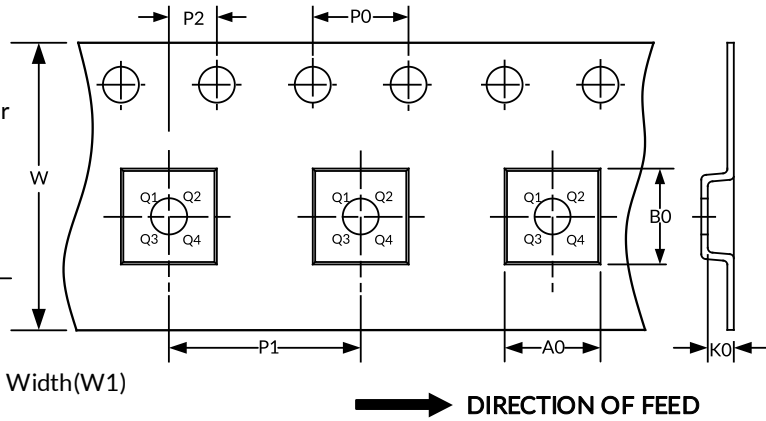

NOTE: The picture is only for reference. Please make the object as the standard.

KEY PARAMETER LIST OF TAPE AND REEL

Package Type	Reel Diameter	Reel Width(mm)	A0 (mm)	B0 (mm)	K0 (mm)	P0 (mm)	P1 (mm)	P2 (mm)	W (mm)	Pin1 Quadrant
SOT23-5	7"	9.5	3.20	3.20	1.40	4.0	4.0	2.0	8.0	Q3
SC70-5	7"	9.5	2.25	2.55	1.20	4.0	4.0	2.0	8.0	Q3
MSOP8	13"	12.4	5.20	3.30	1.50	4.0	8.0	2.0	12.0	Q1
SOP8	13"	12.4	6.40	5.40	2.10	4.0	8.0	2.0	12.0	Q1
TSSOP14	13"	12.4	6.95	5.60	1.20	4.0	8.0	2.0	12.0	Q1
SOP14	13"	16.4	6.60	9.30	2.10	4.0	8.0	2.0	16.0	Q1

NOTE:

1. All dimensions are nominal.
2. Plastic or metal protrusions of 0.15mm maximum per side are not included.

IMPORTANT NOTICE AND DISCLAIMER

Jiangsu Runic Technology Co., Ltd. will accurately and reliably provide technical and reliability data (including data sheets), design resources (including reference designs), application or other design advice, WEB tools, safety information and other resources, without warranty of any defect, and will not make any express or implied warranty, including but not limited to the warranty of merchantability Implied warranty that it is suitable for a specific purpose or does not infringe the intellectual property rights of any third party.

These resources are intended for skilled developers designing with Runic products You will be solely responsible for: (1) Selecting the appropriate products for your application; (2) Designing, validating and testing your application; (3) Ensuring your application meets applicable standards and any other safety, security or other requirements; (4) Runic and the Runic logo are registered trademarks of Runic Incorporated. All trademarks are the property of their respective owners; (5) For change details, review the revision history included in any revised document. The resources are subject to change without notice. Our company will not be liable for the use of this product and the infringement of patents or third-party intellectual property rights due to its use.