

Low Quiescent Current Power Distribution Switch

1 FEATURES

- **Ultra-Low On Resistance (R_{ON})**
 $R_{ON} = 20m\Omega$ at $V_{IN}=5V$ ($V_{BIAS} = 5V$)
- **Input Voltage (V_{IN}) from 0.6V to 5.5V**
- **Supply Voltage (V_{BIAS}) from 2.5V to 5.5V**
- **Low Quiescent Current :35 μ A (TYP) at $V_{BIAS} = V_{IN} = 5V$**
- **6A Maximum Continuous Switch Current**
- **Low Control Input Threshold Enables Use of 1.2V, 1.8V, 2.5V, and 3.3V Logic**
- **Quick Output Discharge**
- **Configurable Rise Time**
- **Lead-Free Packages: DFN2X2-8**

2 APPLICATIONS

- Tablet PC
- Notebooks and Netbooks
- Solid State Drivers
- Telecom Systems
- Set-top Boxes

3 DESCRIPTIONS

The RS2580 is a single channel load switch that provides configurable rise time to minimize inrush current. The device contains an N-channel MOSFET that can operate over an input voltage range of 0.6V to 5.5V and can support a maximum continuous current of 6 A.

The switch is controlled by an on and off input (ON), which is capable of interfacing directly with low-voltage control signals. In the RS2580, a 220 Ω on-chip load resistor is added for quick output discharge when switch is turned off.

The RS2580 is available in DFN2X2-8 package with integrated thermal pad allowing for high power dissipation.

The device is characterized for operation over the free-air temperature range of -40 $^{\circ}$ C to +105 $^{\circ}$ C.

Device Information (1)

PART NUMBER	PACKAGE	BODY SIZE (NOM)
RS2580	DFN2X2-8	2.00mm \times 2.00mm

(1) For all available packages, see the orderable addendum at the end of the data sheet.

4 TYPICAL APPLICATION CIRCUIT

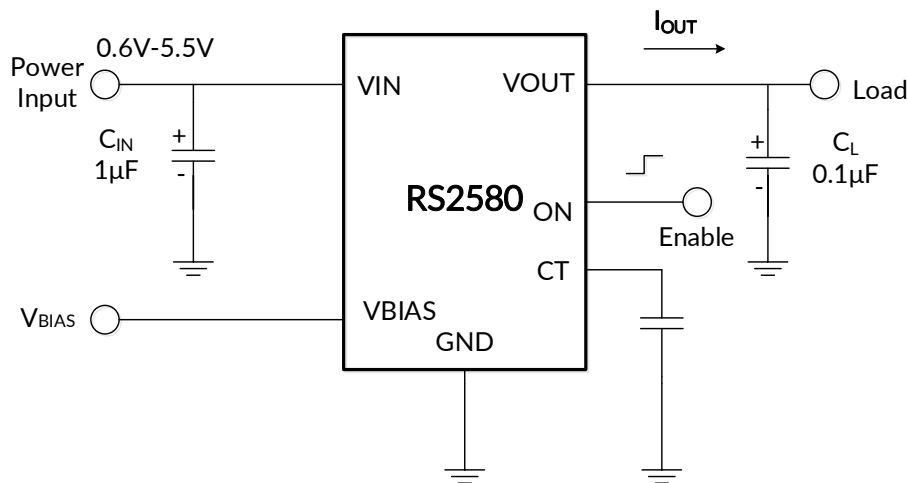

5 FUNCTIONAL BLOCK DIAGRAM

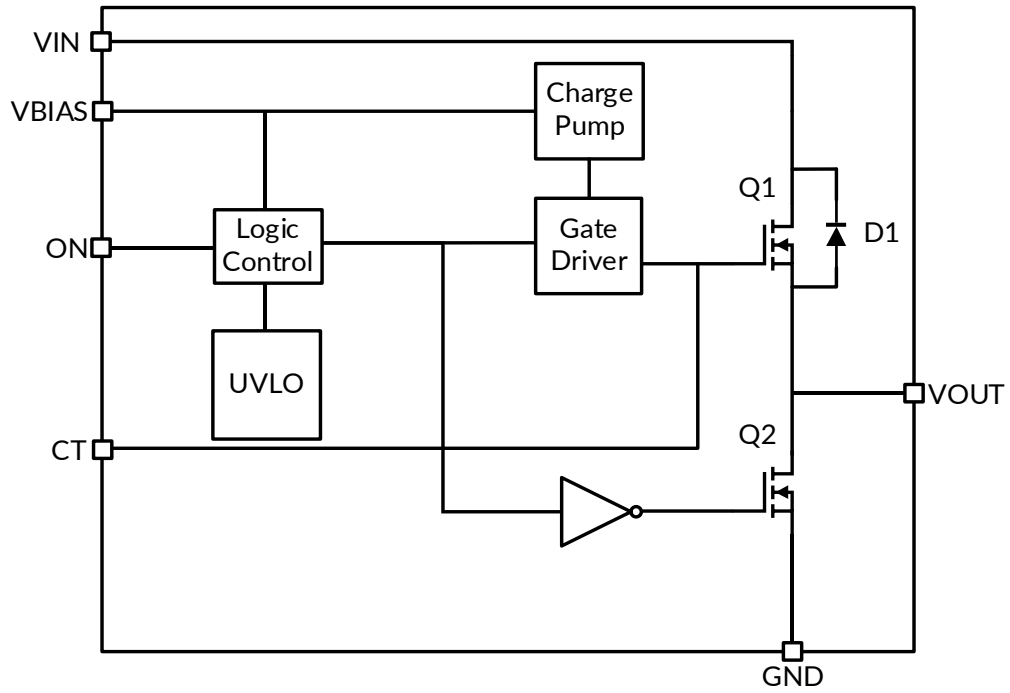

Table of Contents

1 FEATURES	1
2 APPLICATIONS	1
3 DESCRIPTIONS	1
4 TYPICAL APPLICATION CIRCUIT	1
5 FUNCTIONAL BLOCK DIAGRAM	2
6 REVISION HISTORY	4
7 PACKAGE/ORDERING INFORMATION	5
8 PIN CONFIGURATIONS	6
9 SPECIFICATIONS	7
9.1 Absolute Maximum Ratings	7
9.2 ESD Ratings	7
9.3 Recommended Operating Conditions	7
9.4 Electrical Characteristics	8
9.5 Switching Characteristics	10
9.6 PARAMETER MEASUREMENT INFORMATION	13
9.7 Typical Performance Characteristics	14
10 FUNCTIONAL DESCRIPTION	20
10.1 Overview	20
10.2 BIAS Under-voltage Lockout (UVLO)	20
10.3 Soft-Start	20
10.4 Enable Control	20
10.5 Turn-On & Turn-off the device	20
10.6 Supply filter capacitor	20
10.7 Adjustable Rise Time	20
10.8 Inrush Current	21
10.9 Power dissipation	21
11 LAYOUT	22
11.1 Layout Guidelines	22
11.2 Layout Example	22
12 PACKAGE OUTLINE DIMENSIONS	23
13 TAPE AND REEL INFORMATION	24

6 REVISION HISTORY

Note: Page numbers for previous revisions may differ from page numbers in the current version.

VERSION	Change Date	Change Item
A.0	2022/04/18	Initial version completed
A.1	2022/06/16	Official version completed
A.2	2023/10/17	Update Switch resistance
A.2.1	2024/02/23	Modify packaging naming
A.3	2025/03/04	1. Add MSL 2. Update V_{IN} PARAMETER

7 PACKAGE/ORDERING INFORMATION ⁽¹⁾

PRODUCT	ORDERING NUMBER	TEMPERATURE RANGE	PACKAGE LEAD	PACKAGE MARKING ⁽²⁾	MSL ⁽³⁾	PACKAGE OPTION
RS2580	RS2580XTDE8	-40°C ~+105°C	DFN2X2-8	2580	MSL3	Tape and Reel,3000

NOTE:

- (1) This information is the most current data available for the designated devices. This data is subject to change without notice and revision of this document. For browser-based versions of this data sheet, refer to the right-hand navigation.
- (2) There may be additional marking, which relates to the lot trace code information (data code and vendor code), the logo or the environmental category on the device.
- (3) Runic classify the MSL level with using the common preconditioning setting in our assembly factory conforming to the JEDEC industrial standard J-STD-20F, Please align with Runic if your end application is quite critical to the preconditioning setting or if you have special requirement.

8 PIN CONFIGURATIONS

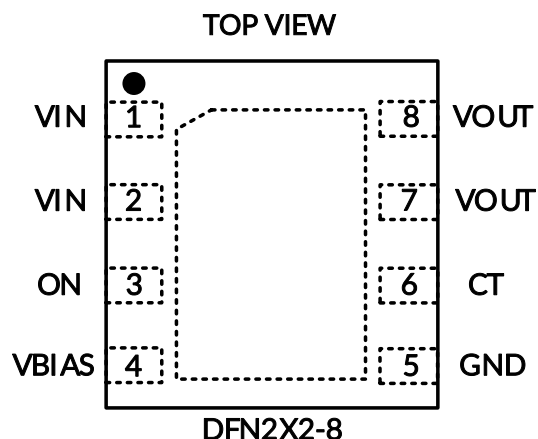

PIN	NAME	TYPE ⁽¹⁾	DESCRIPTION
DFN2X2-8			
1,2	VIN	I	Switch input. Input bypass capacitor recommended for minimizing VIN dip. Must be connected to Pin 1 and Pin 2.
3	ON	I	Active high switch control input. Must do not leave floating.
4	VBIAS	I	Bias voltage. Power supply to the device. Recommended voltage range for this pin is 2.5V to 5.5V.
5	GND	--	Ground.
6	CT	O	Switch slew rate control. Can be left floating.
7,8	VOUT	O	Switch output. Must be connected to Pin 7 and Pin 8.
--	Thermal Pad	--	Thermal pad (exposed center pad) to alleviate thermal stress. Tie to GND.

(1) I=input, O=output

9 SPECIFICATIONS

9.1 Absolute Maximum Ratings

over operating free-air temperature range (unless otherwise noted) ⁽¹⁾⁽²⁾

Characteristics	Symbol	MIN	MAX	UNIT
V _{IN} /V _{BIAS} /V _{ON} /V _{OUT} Input Voltage		-0.3	6.0	V
Maximum continuous switch current	I _{MAX}		6	A
Maximum pulsed switch current, pulse < 300 μs, 2% duty cycle	I _{PLS}		8	A
Package thermal impedance ⁽³⁾	DFN2X2-8	θ _{JA}	118	°C/W
Operating Junction Temperature	T _{opr}	-40	+125	°C
Storage Temperature	T _{stg}	-65	+150	°C
Lead Temperature (Soldering, 10secs)			260	°C

(1) Stresses beyond those listed under *Absolute Maximum Ratings* may cause permanent damage to the device. These are stress ratings only, and functional operation of the device at these or any other conditions beyond those indicated under *Recommended Operating Conditions* is not implied. Exposure to absolute-maximum-rated conditions for extended periods may affect device reliability.

(2) All voltages are with respect to the GND pin.

(3) The package thermal impedance is calculated in accordance with JESD-51.

9.2 ESD Ratings

The following ESD information is provided for handling of ESD-sensitive devices in an ESD protected area only.

		VALUE	UNIT
V _(ESD)	Electrostatic discharge	Human-body model (HBM)	±2000
		Charge device model (CDM)	±1500



ESD SENSITIVITY CAUTION

ESD damage can range from subtle performance degradation to complete device failure. Precision integrated circuits may be more susceptible to damage because very small parametric changes could cause the device not to meet its published specifications.

9.3 Recommended Operating Conditions

over operating free-air temperature range (unless otherwise noted)

Characteristics	Symbol	MIN	MAX	UNIT
Input Voltage	V _{IN}	0.6	V _{BIAS}	V
Bias Voltage	V _{BIAS}	2.5	5.5	V
ON Voltage range	V _{ON}	0	5.5	V
Output Voltage	V _{OUT}		V _{IN}	V
Input Capacitor	C _{IN}	1		μF
Operating Temperature Range	T _A	-40	+105	°C

9.4 Electrical Characteristics

(At $V_{IN}=V_{BIAS}=2.5V$, $T_A = +25^{\circ}C$, unless otherwise noted.)

PARAMETER	SYMBOL	CONDITIONS	TEMP	MIN	TYP	MAX	UNIT	
Input Voltage	V_{IN}			0.6		5.5	V	
Bias Input Voltage	V_{BIAS}			2.5		5.5	V	
Bias supply current	I_{BIAS}	Switch on, $V_{OUT} = \text{open}$	$-40^{\circ}C$ to $+105^{\circ}C$		30	40	μA	
Bias supply current at Shutdown	I_{BIAS_SD}	Switch off, $V_{OUT} = \text{open}$	$-40^{\circ}C$ to $+105^{\circ}C$		0.01	1.0	μA	
V_{IN} off-state supply current	I_{VIN_SD}	Switch off, $V_{IN}=2.5V$, $V_{OUT} = \text{open}$	$-40^{\circ}C$ to $+105^{\circ}C$		0.01	10	μA	
		Switch off, $V_{IN}=1.8V$, $V_{OUT} = \text{open}$	$-40^{\circ}C$ to $+105^{\circ}C$		0.01	10		
		Switch off, $V_{IN}=1.2V$, $V_{OUT} = \text{open}$	$-40^{\circ}C$ to $+105^{\circ}C$		0.01	10		
		Switch off, $V_{IN}=0.8V$, $V_{OUT} = \text{open}$	$-40^{\circ}C$ to $+105^{\circ}C$		0.01	10		
ON pin input leakage current	I_{ON}	$V_{ON}=5.5V$	$-40^{\circ}C$ to $+105^{\circ}C$		0.01	1.0	μA	
Enable input threshold	V_{IL}	$V_{BIAS} = 2.5V$	$-40^{\circ}C$ to $+105^{\circ}C$			0.4	V	
	V_{IH}	$V_{BIAS} = 2.5V$	$-40^{\circ}C$ to $+105^{\circ}C$	1.2			V	
Switch resistance	$R_{DS(ON)}$	$I_{OUT} = 200mA$ (Include bonding wire)	$V_{IN}=2.5V$	25 $^{\circ}C$		24	$m\Omega$	
				$-40^{\circ}C$ to $+85^{\circ}C$				35
				$-40^{\circ}C$ to $+105^{\circ}C$				37
				25 $^{\circ}C$		22		
				$-40^{\circ}C$ to $+85^{\circ}C$				31
				$-40^{\circ}C$ to $+105^{\circ}C$				33
			$V_{IN}=1.8V$	25 $^{\circ}C$		22		
				$-40^{\circ}C$ to $+85^{\circ}C$				31
				$-40^{\circ}C$ to $+105^{\circ}C$				33
			$V_{IN}=1.5V$	25 $^{\circ}C$		22		
				$-40^{\circ}C$ to $+85^{\circ}C$				31
				$-40^{\circ}C$ to $+105^{\circ}C$				33
$V_{IN}=1.2V$	25 $^{\circ}C$		21					
	$-40^{\circ}C$ to $+85^{\circ}C$			30				
	$-40^{\circ}C$ to $+105^{\circ}C$			32				
$V_{IN}=0.8V$	25 $^{\circ}C$		21					
	$-40^{\circ}C$ to $+85^{\circ}C$			29				
	$-40^{\circ}C$ to $+105^{\circ}C$			31				
V_{OUT} shutdown discharge resistance	R_{DIS}	$V_{ON} = 0V$, $I_{OUT} = 1mA$	25 $^{\circ}C$		220	330	Ω	

Electrical Characteristics

(At $V_{IN}=V_{BIAS}=5V$, $T_A = +25^{\circ}C$, unless otherwise noted.)

PARAMETER	SYMBOL	CONDITIONS	TEMP	MIN	TYP	MAX	UNIT		
Input Voltage	V_{IN}			0.6		5.5	V		
Bias Input Voltage	V_{BIAS}			2.5		5.5	V		
Bias supply current	I_{BIAS}	Switch on, $V_{OUT} = \text{open}$	$-40^{\circ}C$ to $+105^{\circ}C$		35	45	μA		
Bias supply current at Shutdown	I_{BIAS_SD}	Switch off, $V_{OUT} = \text{open}$	$-40^{\circ}C$ to $+105^{\circ}C$		0.01	1.0	μA		
V_{IN} off-state supply current	I_{VIN_SD}	Switch off, $V_{IN}=5V$, $V_{OUT} = \text{open}$	$-40^{\circ}C$ to $+105^{\circ}C$		0.01	20	μA		
		Switch off, $V_{IN}=3.3V$, $V_{OUT} = \text{open}$	$-40^{\circ}C$ to $+105^{\circ}C$		0.01	15			
		Switch off, $V_{IN}=1.8V$, $V_{OUT} = \text{open}$	$-40^{\circ}C$ to $+105^{\circ}C$		0.01	10			
		Switch off, $V_{IN}=0.8V$, $V_{OUT} = \text{open}$	$-40^{\circ}C$ to $+105^{\circ}C$		0.01	10			
ON pin input leakage current	I_{ON}	$V_{ON}=5.5V$	$-40^{\circ}C$ to $+105^{\circ}C$		0.01	1.0	μA		
Enable input threshold	V_{IL}	$V_{BIAS} = 5V$	$-40^{\circ}C$ to $+105^{\circ}C$			0.4	V		
	V_{IH}	$V_{BIAS} = 5V$	$-40^{\circ}C$ to $+105^{\circ}C$	1.2			V		
Switch resistance	$R_{DS(ON)}$	$I_{OUT} = 200mA$ (Include bonding wire)	$V_{IN}=5V$	25 $^{\circ}C$		20	$m\Omega$		
				$-40^{\circ}C$ to $+85^{\circ}C$				29	
				$-40^{\circ}C$ to $+105^{\circ}C$				31	
			$V_{IN}=3.3V$	25 $^{\circ}C$		20			
				$-40^{\circ}C$ to $+85^{\circ}C$					29
				$-40^{\circ}C$ to $+105^{\circ}C$					31
			$V_{IN}=1.8V$	25 $^{\circ}C$		20			
				$-40^{\circ}C$ to $+85^{\circ}C$					29
				$-40^{\circ}C$ to $+105^{\circ}C$					31
			$V_{IN}=1.5V$	25 $^{\circ}C$		20			
				$-40^{\circ}C$ to $+85^{\circ}C$					29
				$-40^{\circ}C$ to $+105^{\circ}C$					31
			$V_{IN}=1.2V$	25 $^{\circ}C$		20			
				$-40^{\circ}C$ to $+85^{\circ}C$					28
				$-40^{\circ}C$ to $+105^{\circ}C$					30
			$V_{IN}=0.8V$	25 $^{\circ}C$		20			
$-40^{\circ}C$ to $+85^{\circ}C$				28					
$-40^{\circ}C$ to $+105^{\circ}C$				30					
V_{OUT} shutdown discharge resistance	R_{DIS}	$V_{ON} = 0V$, $I_{OUT} = 15mA$	25 $^{\circ}C$		195	300	Ω		

9.5 Switching Characteristics

PARAMETER	TEST CONDITIONS	MIN	TYP	MAX	UNIT
V _{BIAS} = V _{ON} = V _{IN} = 5V, T _A =25°C (unless otherwise noted)					
t _{ON} Turn on time	R _L = 10 Ω, C _L = 0.1μF, C _T = 1000 pF		1680		us
t _{OFF} Turn off time	R _L = 10 Ω, C _L = 0.1μF, C _T = 1000 pF		18		
t _R V _{OUT} rise time	R _L = 10 Ω, C _L = 0.1μF, C _T = 1000 pF		2050		
t _F V _{OUT} fall time	R _L = 10 Ω, C _L = 0.1μF, C _T = 1000 pF		11		
t _D ON delay time	R _L = 10 Ω, C _L = 0.1μF, C _T = 1000 pF		605		
V _{BIAS} = V _{ON} = 5V, V _{IN} = 3.3V, T _A =25°C (unless otherwise noted)					
t _{ON} Turn on time	R _L = 10 Ω, C _L = 0.1μF, C _T = 1000 pF		1240		us
t _{OFF} Turn off time	R _L = 10 Ω, C _L = 0.1μF, C _T = 1000 pF		20		
t _R V _{OUT} rise time	R _L = 10 Ω, C _L = 0.1μF, C _T = 1000 pF		1395		
t _F V _{OUT} fall time	R _L = 10 Ω, C _L = 0.1μF, C _T = 1000 pF		9		
t _D ON delay time	R _L = 10 Ω, C _L = 0.1μF, C _T = 1000 pF		510		
V _{BIAS} = V _{ON} = 5V, V _{IN} = 2.5V, T _A =25°C (unless otherwise noted)					
t _{ON} Turn on time	R _L = 10 Ω, C _L = 0.1μF, C _T = 1000 pF		1040		us
t _{OFF} Turn off time	R _L = 10 Ω, C _L = 0.1μF, C _T = 1000 pF		20		
t _R V _{OUT} rise time	R _L = 10 Ω, C _L = 0.1μF, C _T = 1000 pF		1085		
t _F V _{OUT} fall time	R _L = 10 Ω, C _L = 0.1μF, C _T = 1000 pF		8		
t _D ON delay time	R _L = 10 Ω, C _L = 0.1μF, C _T = 1000 pF		460		
V _{BIAS} = V _{ON} = 5V, V _{IN} = 1.8V, T _A =25°C (unless otherwise noted)					
t _{ON} Turn on time	R _L = 10 Ω, C _L = 0.1μF, C _T = 1000 pF		865		us
t _{OFF} Turn off time	R _L = 10 Ω, C _L = 0.1μF, C _T = 1000 pF		20		
t _R V _{OUT} rise time	R _L = 10 Ω, C _L = 0.1μF, C _T = 1000 pF		790		
t _F V _{OUT} fall time	R _L = 10 Ω, C _L = 0.1μF, C _T = 1000 pF		7		
t _D ON delay time	R _L = 10 Ω, C _L = 0.1μF, C _T = 1000 pF		455		
V _{BIAS} = V _{ON} = 5V, V _{IN} = 1.5V, T _A =25°C (unless otherwise noted)					
t _{ON} Turn on time	R _L = 10 Ω, C _L = 0.1μF, C _T = 1000 pF		785		us
t _{OFF} Turn off time	R _L = 10 Ω, C _L = 0.1μF, C _T = 1000 pF		21		
t _R V _{OUT} rise time	R _L = 10 Ω, C _L = 0.1μF, C _T = 1000 pF		670		
t _F V _{OUT} fall time	R _L = 10 Ω, C _L = 0.1μF, C _T = 1000 pF		6		
t _D ON delay time	R _L = 10 Ω, C _L = 0.1μF, C _T = 1000 pF		440		
V _{BIAS} = V _{ON} = 5V, V _{IN} = 1.2V, T _A =25°C (unless otherwise noted)					
t _{ON} Turn on time	R _L = 10 Ω, C _L = 0.1μF, C _T = 1000 pF		725		us
t _{OFF} Turn off time	R _L = 10 Ω, C _L = 0.1μF, C _T = 1000 pF		22		
t _R V _{OUT} rise time	R _L = 10 Ω, C _L = 0.1μF, C _T = 1000 pF		570		
t _F V _{OUT} fall time	R _L = 10 Ω, C _L = 0.1μF, C _T = 1000 pF		6		
t _D ON delay time	R _L = 10 Ω, C _L = 0.1μF, C _T = 1000 pF		420		
V _{BIAS} = V _{ON} = 5V, V _{IN} = 0.8V, T _A =25°C (unless otherwise noted)					

t_{ON}	Turn on time	$R_L = 10 \Omega, C_L = 0.1\mu F, C_T = 1000 \text{ pF}$		615		us
t_{OFF}	Turn off time	$R_L = 10 \Omega, C_L = 0.1\mu F, C_T = 1000 \text{ pF}$		24		
t_R	V_{OUT} rise time	$R_L = 10 \Omega, C_L = 0.1\mu F, C_T = 1000 \text{ pF}$		400		
t_F	V_{OUT} fall time	$R_L = 10 \Omega, C_L = 0.1\mu F, C_T = 1000 \text{ pF}$		5		
t_D	ON delay time	$R_L = 10 \Omega, C_L = 0.1\mu F, C_T = 1000 \text{ pF}$		395		
$V_{BIAS} = 3.3V, V_{ON} = 5V, V_{IN} = 3.3V, T_A=25^\circ C$ (unless otherwise noted)						
t_{ON}	Turn on time	$R_L = 10 \Omega, C_L = 0.1\mu F, C_T = 1000 \text{ pF}$		1315		us
t_{OFF}	Turn off time	$R_L = 10 \Omega, C_L = 0.1\mu F, C_T = 1000 \text{ pF}$		28		
t_R	V_{OUT} rise time	$R_L = 10 \Omega, C_L = 0.1\mu F, C_T = 1000 \text{ pF}$		1480		
t_F	V_{OUT} fall time	$R_L = 10 \Omega, C_L = 0.1\mu F, C_T = 1000 \text{ pF}$		12		
t_D	ON delay time	$R_L = 10 \Omega, C_L = 0.1\mu F, C_T = 1000 \text{ pF}$		540		
$V_{BIAS} = 3.3V, V_{ON} = 5V, V_{IN} = 2.5V, T_A=25^\circ C$ (unless otherwise noted)						
t_{ON}	Turn on time	$R_L = 10 \Omega, C_L = 0.1\mu F, C_T = 1000 \text{ pF}$		1115		us
t_{OFF}	Turn off time	$R_L = 10 \Omega, C_L = 0.1\mu F, C_T = 1000 \text{ pF}$		30		
t_R	V_{OUT} rise time	$R_L = 10 \Omega, C_L = 0.1\mu F, C_T = 1000 \text{ pF}$		1160		
t_F	V_{OUT} fall time	$R_L = 10 \Omega, C_L = 0.1\mu F, C_T = 1000 \text{ pF}$		10		
t_D	ON delay time	$R_L = 10 \Omega, C_L = 0.1\mu F, C_T = 1000 \text{ pF}$		515		
$V_{BIAS} = 3.3V, V_{ON} = 5V, V_{IN} = 1.8V, T_A=25^\circ C$ (unless otherwise noted)						
t_{ON}	Turn on time	$R_L = 10 \Omega, C_L = 0.1\mu F, C_T = 1000 \text{ pF}$		920		us
t_{OFF}	Turn off time	$R_L = 10 \Omega, C_L = 0.1\mu F, C_T = 1000 \text{ pF}$		31		
t_R	V_{OUT} rise time	$R_L = 10 \Omega, C_L = 0.1\mu F, C_T = 1000 \text{ pF}$		830		
t_F	V_{OUT} fall time	$R_L = 10 \Omega, C_L = 0.1\mu F, C_T = 1000 \text{ pF}$		8		
t_D	ON delay time	$R_L = 10 \Omega, C_L = 0.1\mu F, C_T = 1000 \text{ pF}$		465		
$V_{BIAS} = 3.3V, V_{ON} = 5V, V_{IN} = 1.5V, T_A=25^\circ C$ (unless otherwise noted)						
t_{ON}	Turn on time	$R_L = 10 \Omega, C_L = 0.1\mu F, C_T = 1000 \text{ pF}$		830		us
t_{OFF}	Turn off time	$R_L = 10 \Omega, C_L = 0.1\mu F, C_T = 1000 \text{ pF}$		33		
t_R	V_{OUT} rise time	$R_L = 10 \Omega, C_L = 0.1\mu F, C_T = 1000 \text{ pF}$		695		
t_F	V_{OUT} fall time	$R_L = 10 \Omega, C_L = 0.1\mu F, C_T = 1000 \text{ pF}$		7		
t_D	ON delay time	$R_L = 10 \Omega, C_L = 0.1\mu F, C_T = 1000 \text{ pF}$		440		
$V_{BIAS} = 3.3V, V_{ON} = 5V, V_{IN} = 1.2V, T_A=25^\circ C$ (unless otherwise noted)						
t_{ON}	Turn on time	$R_L = 10 \Omega, C_L = 0.1\mu F, C_T = 1000 \text{ pF}$		760		us
t_{OFF}	Turn off time	$R_L = 10 \Omega, C_L = 0.1\mu F, C_T = 1000 \text{ pF}$		34		
t_R	V_{OUT} rise time	$R_L = 10 \Omega, C_L = 0.1\mu F, C_T = 1000 \text{ pF}$		605		
t_F	V_{OUT} fall time	$R_L = 10 \Omega, C_L = 0.1\mu F, C_T = 1000 \text{ pF}$		7		
t_D	ON delay time	$R_L = 10 \Omega, C_L = 0.1\mu F, C_T = 1000 \text{ pF}$		435		
$V_{BIAS} = 3.3V, V_{ON} = 5V, V_{IN} = 0.8V, T_A=25^\circ C$ (unless otherwise noted)						
t_{ON}	Turn on time	$R_L = 10 \Omega, C_L = 0.1\mu F, C_T = 1000 \text{ pF}$		645		us
t_{OFF}	Turn off time	$R_L = 10 \Omega, C_L = 0.1\mu F, C_T = 1000 \text{ pF}$		36		
t_R	V_{OUT} rise time	$R_L = 10 \Omega, C_L = 0.1\mu F, C_T = 1000 \text{ pF}$		420		

t_F	V_{OUT} fall time	$R_L = 10 \Omega, C_L = 0.1\mu F, C_T = 1000 \text{ pF}$		5		
t_D	ON delay time	$R_L = 10 \Omega, C_L = 0.1\mu F, C_T = 1000 \text{ pF}$		410		
$V_{BIAS} = 2.5V, V_{ON} = 5V, V_{IN} = 2.5V, T_A = 25^\circ C$ (unless otherwise noted)						
t_{ON}	Turn on time	$R_L = 10 \Omega, C_L = 0.1\mu F, C_T = 1000 \text{ pF}$		1145		us
t_{OFF}	Turn off time	$R_L = 10 \Omega, C_L = 0.1\mu F, C_T = 1000 \text{ pF}$		37		
t_R	V_{OUT} rise time	$R_L = 10 \Omega, C_L = 0.1\mu F, C_T = 1000 \text{ pF}$		1175		
t_F	V_{OUT} fall time	$R_L = 10 \Omega, C_L = 0.1\mu F, C_T = 1000 \text{ pF}$		15		
t_D	ON delay time	$R_L = 10 \Omega, C_L = 0.1\mu F, C_T = 1000 \text{ pF}$		525		
$V_{BIAS} = 2.5V, V_{ON} = 5V, V_{IN} = 1.8V, T_A = 25^\circ C$ (unless otherwise noted)						
t_{ON}	Turn on time	$R_L = 10 \Omega, C_L = 0.1\mu F, C_T = 1000 \text{ pF}$		935		us
t_{OFF}	Turn off time	$R_L = 10 \Omega, C_L = 0.1\mu F, C_T = 1000 \text{ pF}$		41		
t_R	V_{OUT} rise time	$R_L = 10 \Omega, C_L = 0.1\mu F, C_T = 1000 \text{ pF}$		860		
t_F	V_{OUT} fall time	$R_L = 10 \Omega, C_L = 0.1\mu F, C_T = 1000 \text{ pF}$		12		
t_D	ON delay time	$R_L = 10 \Omega, C_L = 0.1\mu F, C_T = 1000 \text{ pF}$		490		
$V_{BIAS} = 2.5V, V_{ON} = 5V, V_{IN} = 1.5V, T_A = 25^\circ C$ (unless otherwise noted)						
t_{ON}	Turn on time	$R_L = 10 \Omega, C_L = 0.1\mu F, C_T = 1000 \text{ pF}$		850		us
t_{OFF}	Turn off time	$R_L = 10 \Omega, C_L = 0.1\mu F, C_T = 1000 \text{ pF}$		43		
t_R	V_{OUT} rise time	$R_L = 10 \Omega, C_L = 0.1\mu F, C_T = 1000 \text{ pF}$		735		
t_F	V_{OUT} fall time	$R_L = 10 \Omega, C_L = 0.1\mu F, C_T = 1000 \text{ pF}$		10		
t_D	ON delay time	$R_L = 10 \Omega, C_L = 0.1\mu F, C_T = 1000 \text{ pF}$		460		
$V_{BIAS} = 2.5V, V_{ON} = 5V, V_{IN} = 1.2V, T_A = 25^\circ C$ (unless otherwise noted)						
t_{ON}	Turn on time	$R_L = 10 \Omega, C_L = 0.1\mu F, C_T = 1000 \text{ pF}$		780		us
t_{OFF}	Turn off time	$R_L = 10 \Omega, C_L = 0.1\mu F, C_T = 1000 \text{ pF}$		45		
t_R	V_{OUT} rise time	$R_L = 10 \Omega, C_L = 0.1\mu F, C_T = 1000 \text{ pF}$		615		
t_F	V_{OUT} fall time	$R_L = 10 \Omega, C_L = 0.1\mu F, C_T = 1000 \text{ pF}$		9		
t_D	ON delay time	$R_L = 10 \Omega, C_L = 0.1\mu F, C_T = 1000 \text{ pF}$		450		
$V_{BIAS} = 2.5V, V_{ON} = 5V, V_{IN} = 0.8V, T_A = 25^\circ C$ (unless otherwise noted)						
t_{ON}	Turn on time	$R_L = 10 \Omega, C_L = 0.1\mu F, C_T = 1000 \text{ pF}$		660		us
t_{OFF}	Turn off time	$R_L = 10 \Omega, C_L = 0.1\mu F, C_T = 1000 \text{ pF}$		48		
t_R	V_{OUT} rise time	$R_L = 10 \Omega, C_L = 0.1\mu F, C_T = 1000 \text{ pF}$		435		
t_F	V_{OUT} fall time	$R_L = 10 \Omega, C_L = 0.1\mu F, C_T = 1000 \text{ pF}$		7		
t_D	ON delay time	$R_L = 10 \Omega, C_L = 0.1\mu F, C_T = 1000 \text{ pF}$		425		

9.6 PARAMETER MEASUREMENT INFORMATION

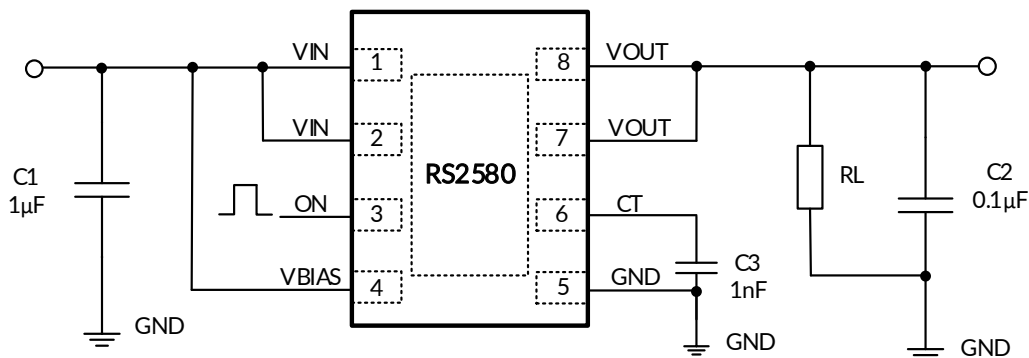

Figure 1. Test circuit

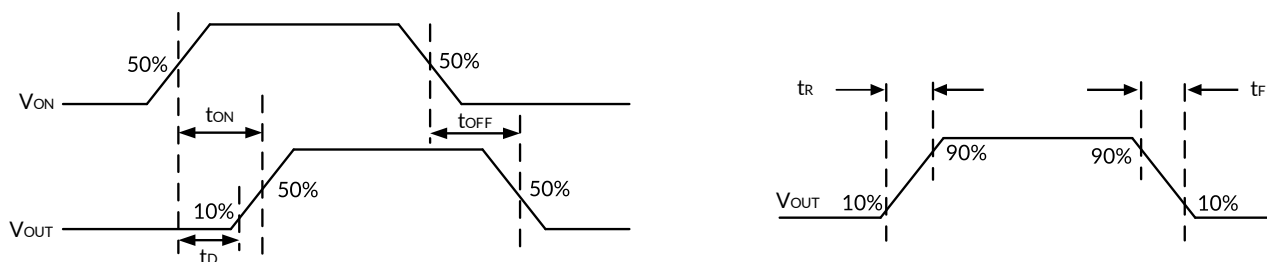

Figure 2. Switch Turn-On and Turn-Off Delay Times

9.7 Typical Performance Characteristics

NOTE: The graphs and tables provided following this note are a statistical summary based on a limited number of samples and are provided for informational purposes only.

T_A = +25°C, unless otherwise noted.

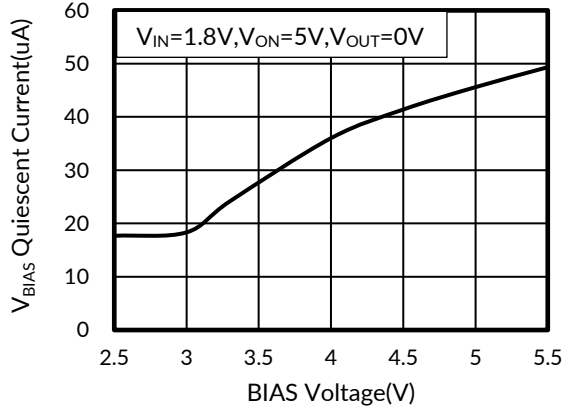

Figure 3. V_{BIAS} Quiescent Current vs BIAS Voltage

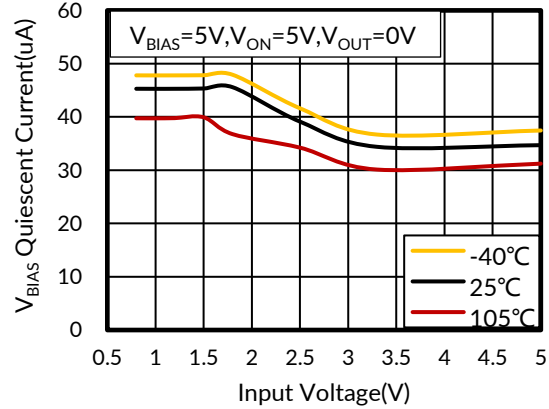

Figure 4. V_{BIAS} Quiescent Current vs Input Voltage

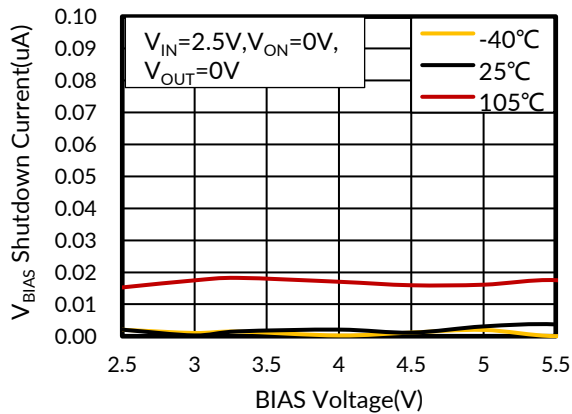

Figure 5. V_{BIAS} Shutdown Current vs BIAS Voltage

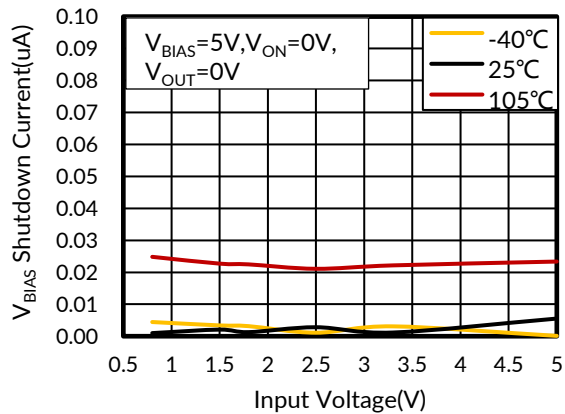

Figure 6. V_{BIAS} Shutdown Current vs Input Voltage

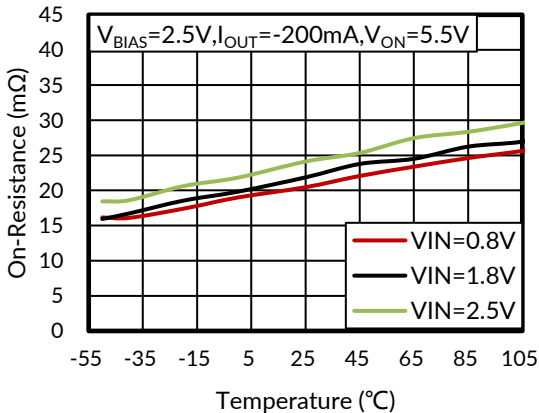

Figure 7. On Resistance vs Temperature

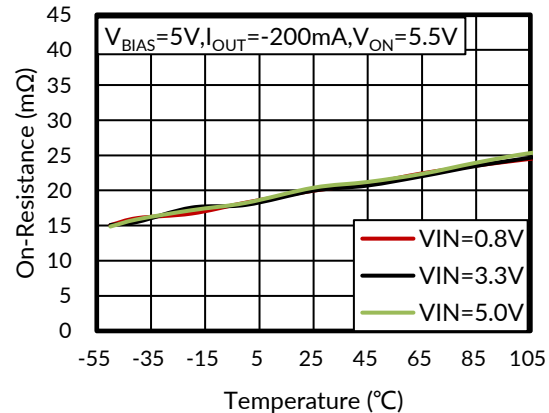

Figure 8. On Resistance vs Temperature

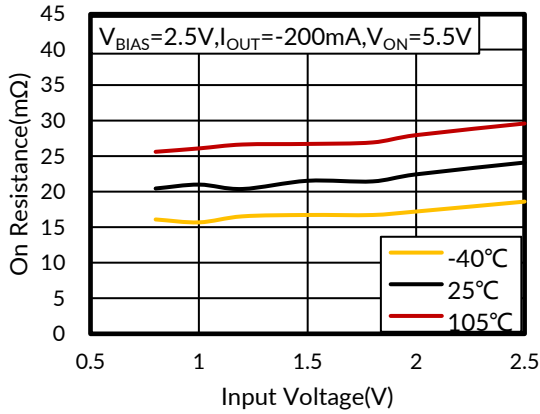

Figure 9. On Resistance vs Input Voltage

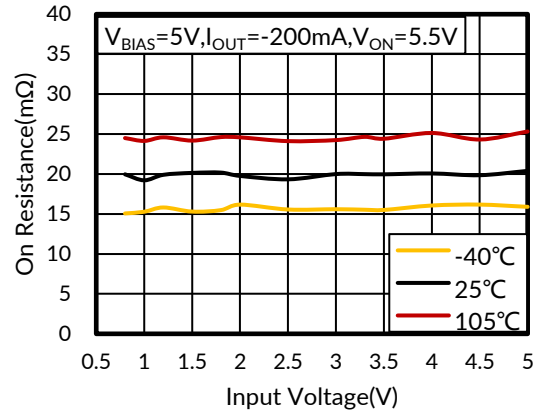

Figure 10. On Resistance vs Input Voltage

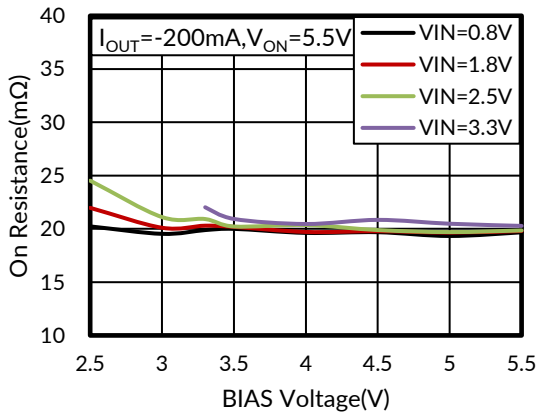

Figure 11. On Resistance vs BIAS Voltage

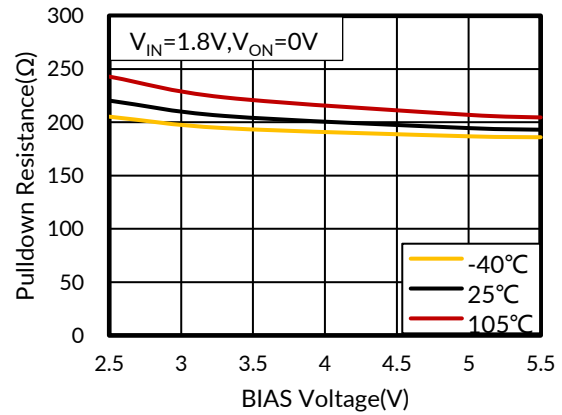

Figure 12. Pulldown Resistance vs BIAS Voltage

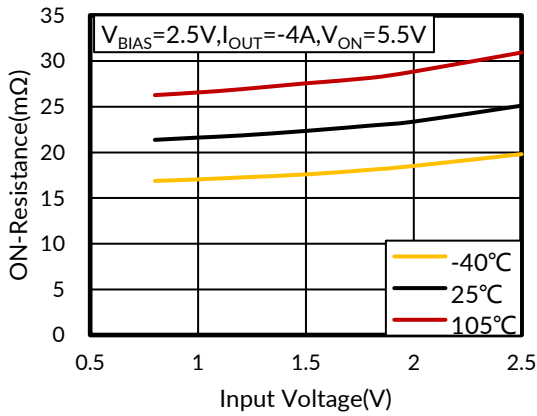

Figure 13. ON-Resistance vs Input Voltage

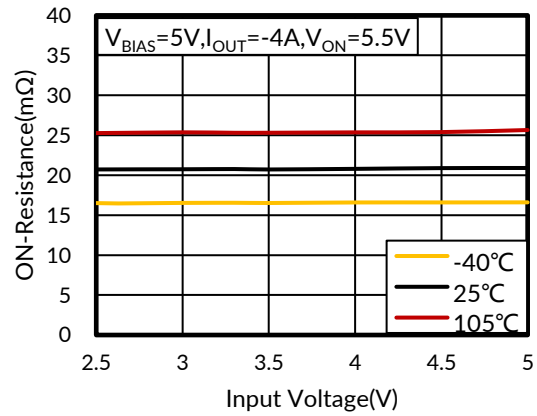

Figure 14. ON-Resistance vs Input Voltage

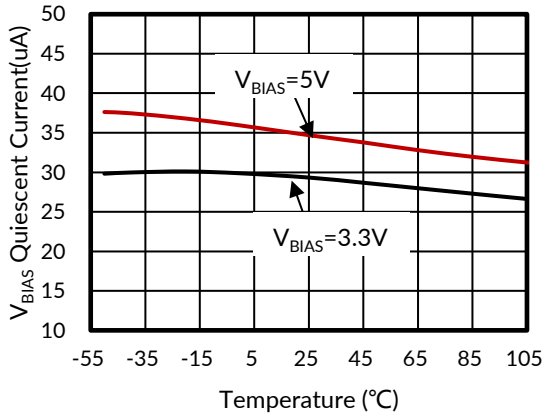

Figure 15. V_{BIAS} Quiescent Current vs Temperature

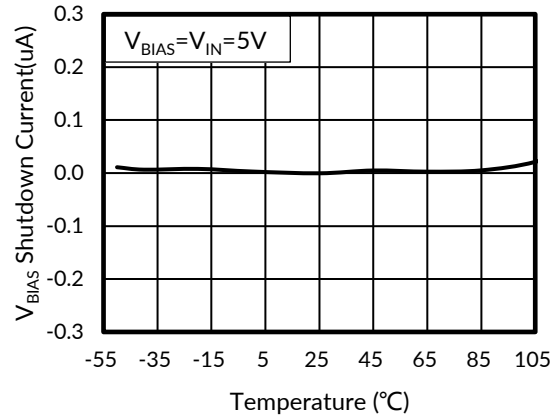

Figure 16. V_{BIAS} Shutdown Current vs Temperature

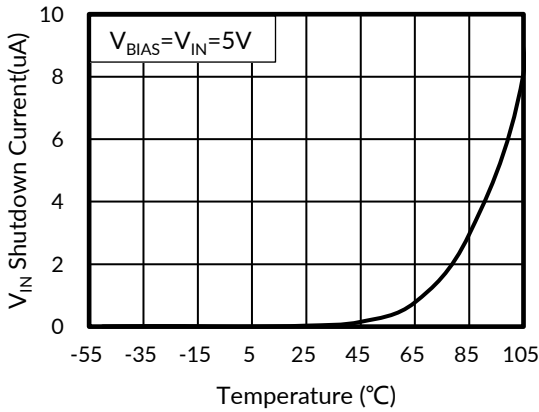

Figure 17. V_{IN} Shutdown Current vs Temperature

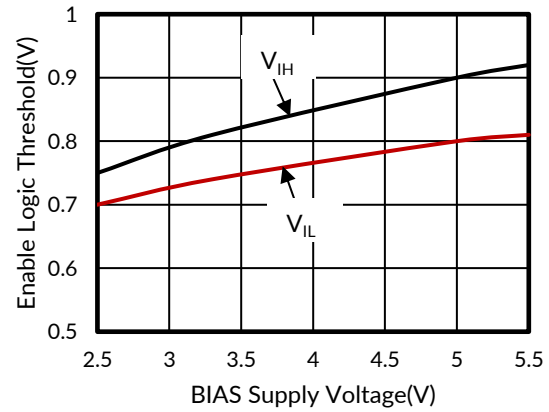

Figure 18. Enable Logic Threshold vs BIAS Supply Voltage

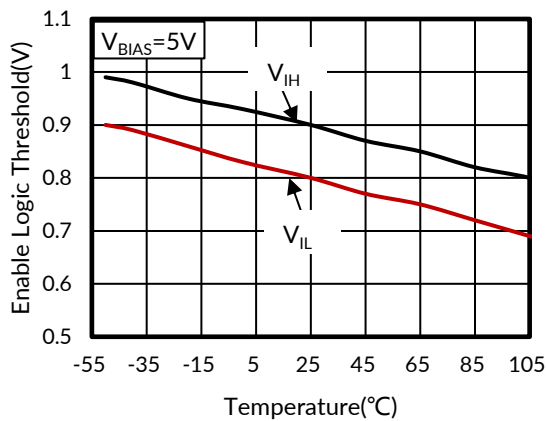

Figure 19. Enable Logic Threshold vs Temperature

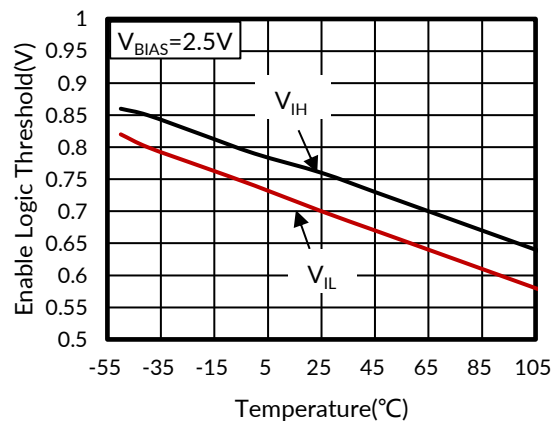

Figure 20. Enable Logic Threshold vs Temperature

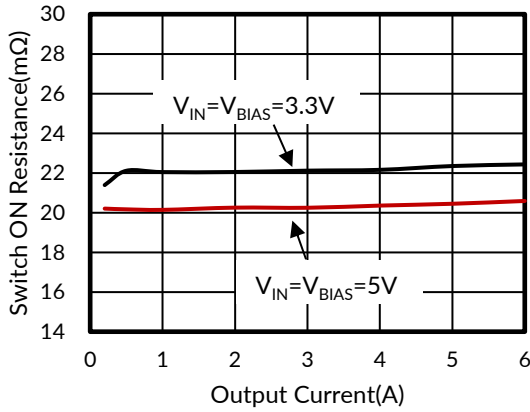

Figure 21. Switch ON Resistance vs Output Current

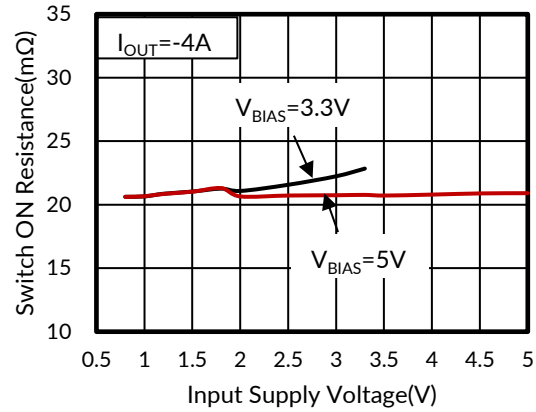

Figure 22. Switch ON Resistance vs Input Supply Voltage

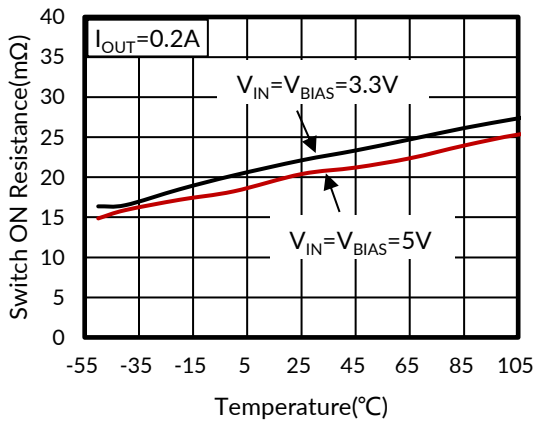

Figure 23. Switch ON Resistance vs Temperature

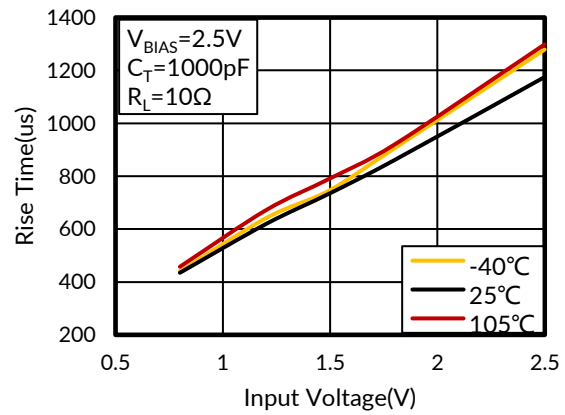

Figure 24. Rise Time vs Input Voltage

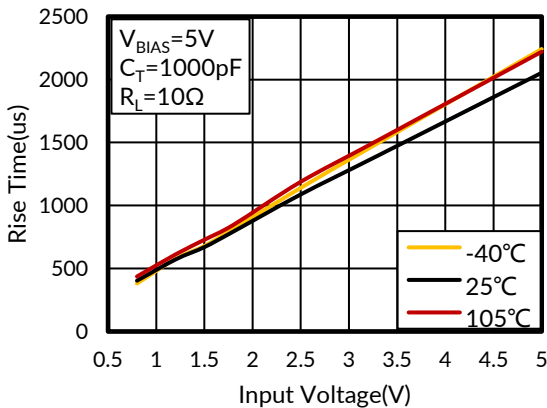

Figure 25. Rise Time vs Input Voltage

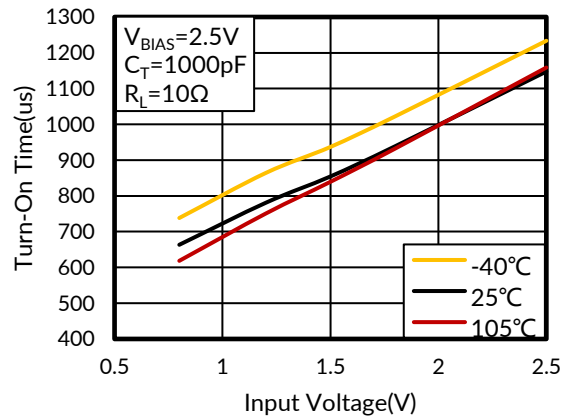

Figure 26. Turn-On Time vs Input Voltage

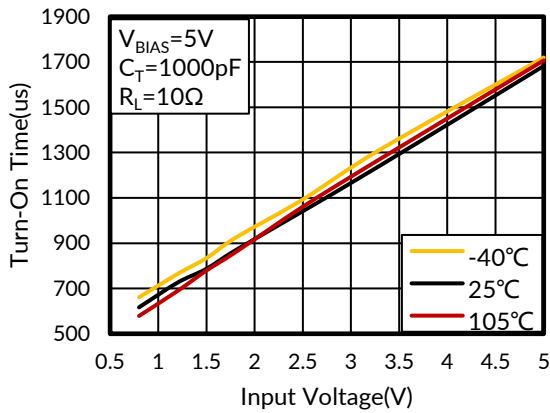

Figure 27. Turn-On Time vs Input Voltage

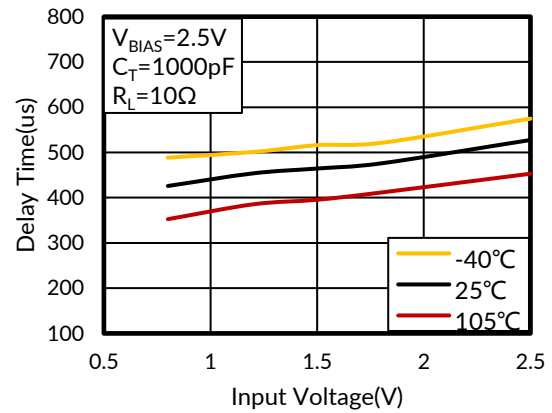

Figure 28. Delay Time vs Input Voltage

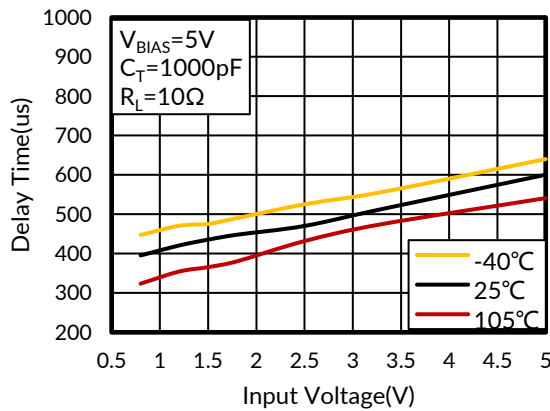

Figure 29. Delay Time vs Input Voltage

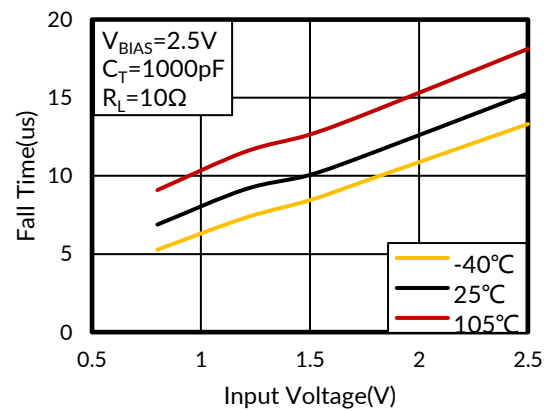

Figure 30. Fall Time vs Input Voltage

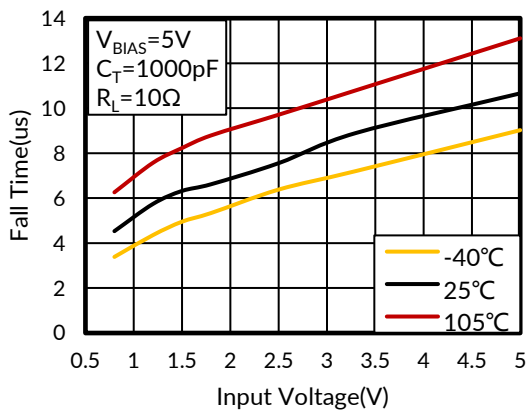

Figure 31. Fall Time vs Input Voltage

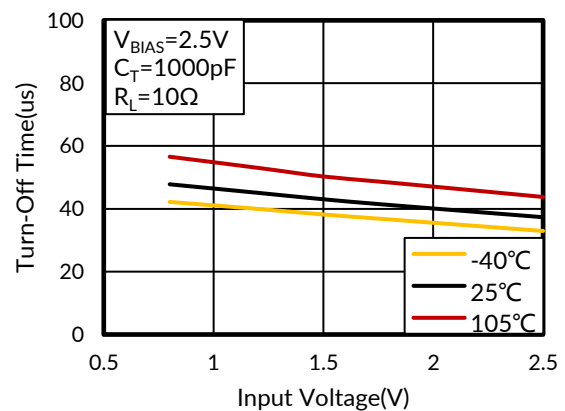

Figure 32. Turn-Off Time vs Input Voltage

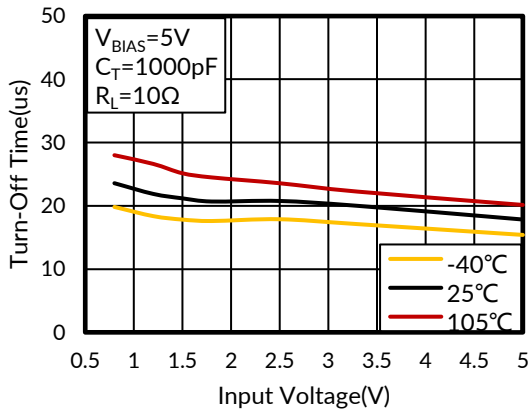

Figure 33. Turn-Off Time vs Input Voltage

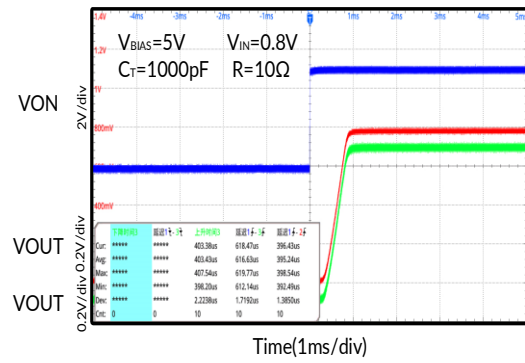

Figure 34. Turn-On Response Time

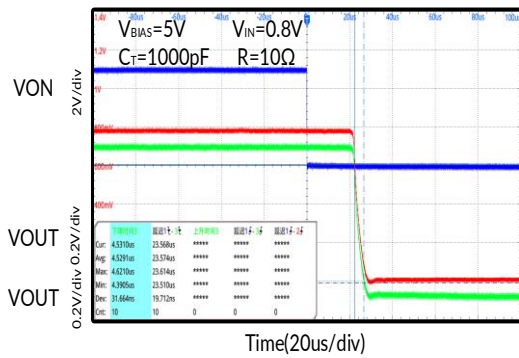

Figure 35. Turn-Off Response Time

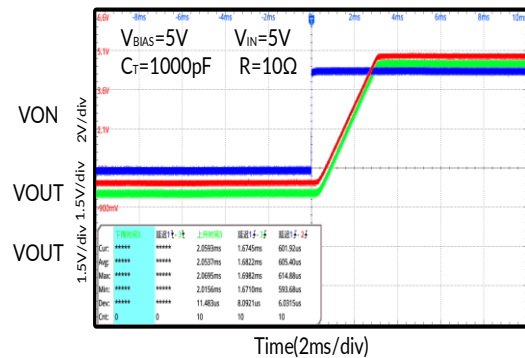

Figure 36. Turn-On Response Time

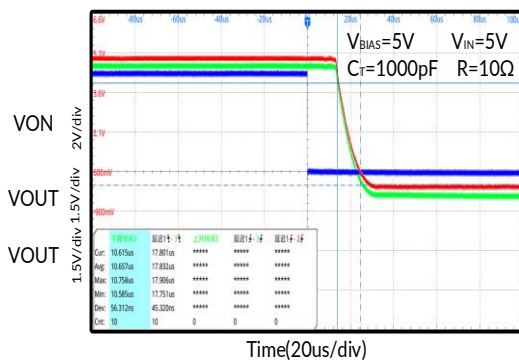

Figure 37. Turn-Off Response Time

10 FUNCTIONAL DESCRIPTION

10.1 Overview

The RS2580 is a single channel load switch that provides configurable rise time to minimize inrush current. The device contains an N-channel MOSFET that can operate over an input voltage range of 0.6V to 5.5V and can support a maximum continuous current of 6 A.

The switch is controlled by an on and off input (ON), which is capable of interfacing directly with low-voltage control signals. In the RS2580, a 220Ω on-chip load resistor is added for quick output discharge when switch is turned off.

The RS2580 is available in DFN2x2-8 package with integrated thermal pad allowing for high power dissipation. The device is characterized for operation over the free-air temperature range of -40°C to +105°C.

10.2 BIAS Under-voltage Lockout (UVLO)

An under-voltage lockout (UVLO) circuit monitors the BIAS pins voltage to prevent wrong logic controls. The UVLO function initiates a soft-start process after the BIAS supply voltages exceed rising UVLO voltage threshold during powering on.

10.3 Soft-Start

The RS2580 Provides an adjustable soft-start circuitry to control rise rate of the output voltage and limit the current surge during start-up. The soft-start time is set with a capacitor from the CT pin to the ground. (see 10.7 Adjustable Rise Time for more details)

10.4 Enable Control

The ON pin controls the state of the switch. Asserting ON high enables the switch. ON is active high and has a low threshold, making it capable of interfacing with low-voltage signals. The ON pin can be used with any microcontroller with 1.2 V or higher GPIO voltage. This pin **cannot be left floating** and must be driven either high or low for proper functionality.

10.5 Turn-On & Turn-off the device

The RS2580 turns on when $V_{BIAS} > UVLO$ & $ON = High$. Make sure V_{BIAS} **cannot be left floating** and **must be powered on before VIN**. For optimal RON performance, **make sure $V_{IN} \leq V_{BIAS}$** . Using $ON = Low$ to turn off the device instead of using $V_{BIAS} < UVLO$ to prevent the ultra-low but unpredictable leakage current which from VIN to OUT result in rising up the OUT voltage.

10.6 Supply filter capacitor

To limit the voltage, drop on the input supply caused by transient inrush currents when the switch turns on into a discharged load capacitor, a capacitor needs to be placed between VIN and GND. A 1-μF ceramic capacitor, CIN, placed close to the pins, is usually sufficient. Higher values of CIN can be used to further reduce the voltage drop during high current applications. When switching heavy loads, it is recommended to have an input capacitor about 10 times higher than the output capacitor to avoid excessive voltage drop.

Because of the integrated body diode in the NMOS switch, a CIN greater than CL is highly recommended. A CL greater than CIN can cause VOUT to exceed VIN when the system supply is removed. This could result in current flow through the body diode from VOUT to VIN. A CIN to CL ratio of 10 to 1 is recommended for minimizing VIN dip caused by inrush currents during startup; however, a 10 to 1 ratio for capacitance is not required for proper functionality of the device. A ratio smaller than 10 to 1 (such as 1 to 1) could cause slightly more VIN dip upon turn-on due to inrush currents. This can be mitigated by increasing the capacitance on the CT pin for a longer rise time (see 10.7 Adjustable Rise Time for more details).

10.7 Adjustable Rise Time

The soft-start capacitor on CT pin can reduce the inrush current and overshoot of output voltage. The soft-start time is set with a capacitor from the CT pin to the ground. The voltage on the CT pin can be as high as 12 V; therefore, the minimum voltage rating for the CT capacitor must be 25 V for optimal performance. The slew rate of VOUT is depended on CT capacitor, the relationship is shown in the equation as below:

$$SR = 0.38 \times CT + 34$$

SR is the slew rate (in us/V) from 10% to 90%

CT is the capacitance value on the CT pin (in pF)

The units for the constant 34 are us/V. The units for the constant 0.38 are us/(V×pF).

An approximate formula for the relationship between CT and slew rate when VBIAS is set to 3.3V is shown in **Table 1** as well VBIAS is set to 5V is shown in **Table 2**.

Table 1. Rise Time vs CT Capacitor

CT (pF)	TYPICAL VALUES at 25°C with a 25 V X7R 10% CERAMIC CAPACITOR on CT ⁽¹⁾					
	V _{IN} = 3.3V	V _{IN} = 1.8V	V _{IN} = 1.5V	V _{IN} = 1.2V	V _{IN} = 1.05V	V _{IN} = 0.8V
0	226	139	118	107	96	79
220	500	292	246	216	195	154
470	832	460	400	347	310	245
1000	1484	834	697	605	540	424
2200	2935	1639	1385	1187	1046	820
4700	6234	3480	2910	2488	2214	1740
10000	14218	7869	6528	5578	4948	3813

(1) Rise time (μs) 10% - 90%, C_L = 0.1 μF, C_{IN} = 1 μF, R_L = 10 Ω, V_{BIAS} = 3.3V.

Table 2. Rise Time vs CT Capacitor

CT (pF)	TYPICAL VALUES at 25°C with a 25 V X7R 10% CERAMIC CAPACITOR on CT ⁽¹⁾						
	V _{IN} = 5V	V _{IN} = 3.3V	V _{IN} = 1.8V	V _{IN} = 1.5V	V _{IN} = 1.2V	V _{IN} = 1.05V	V _{IN} = 0.8V
0	299	212	130	116	100	91	75
220	683	467	275	237	204	185	147
470	1135	773	444	375	324	289	230
1000	2054	1396	793	645	572	506	403
2200	4134	2748	1547	1312	1124	987	777
4700	8714	5818	3264	2760	2356	2088	1627
10000	20246	13290	7436	6165	5295	4605	3620

(1) Rise time (μs) 10% - 90%, C_L = 0.1 μF, C_{IN} = 1 μF, R_L = 10 Ω, V_{BIAS} = 5 V.

10.8 Inrush Current

When the switch is enabled, the output capacitors must be charged up from 0V to the set value. This charge arrives in the form of inrush current. Inrush current can be calculated as follow.

$$\text{Inrush current} = C \times dV/dt$$

Where

C is the output capacitance

dV is the output voltage

dt is the rise time depended on CT capacitance

10.9 Power dissipation

The device's junction temperature depends on several factors such as the load, PCB layout, ambient temperature, and package type. Equations that can be used to calculate power dissipation and junction temperature are found below:

$$P_D = R_{DS(ON)} \times I_{OUT}^2$$

To relate this to junction temperature, the following equation can be used:

$$T_J = P_D \times \theta_{JA} + T_A$$

Where:

T_J = junction temperature

T_A = ambient temperature

θ_{JA} = the thermal resistance of the package

11 LAYOUT

11.1 Layout Guidelines

For best performance, all traces must be as short as possible. To be most effective, the input and output capacitors must be placed close to the device to minimize the effects that parasitic trace inductances may have on normal operation. Using wide traces for VIN, VOUT, and GND helps minimize the parasitic electrical effects along with minimizing the case to ambient thermal impedance. The CT trace must be as short as possible to avoid parasitic capacitance.

11.2 Layout Example

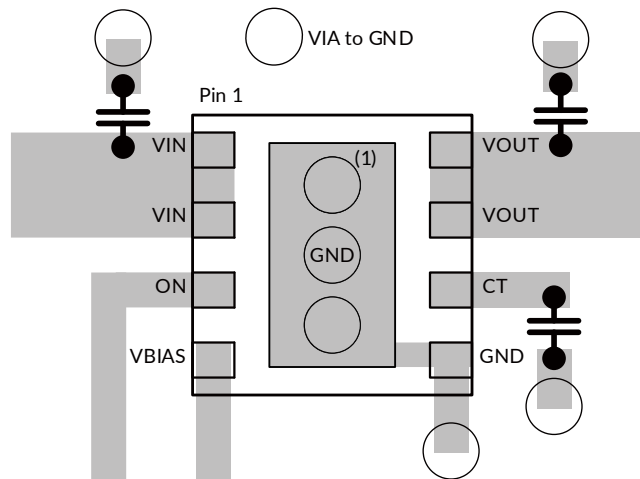
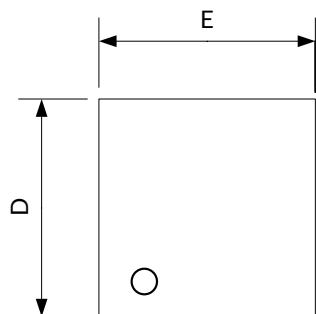
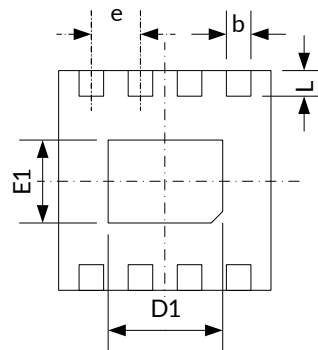
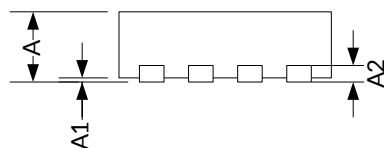
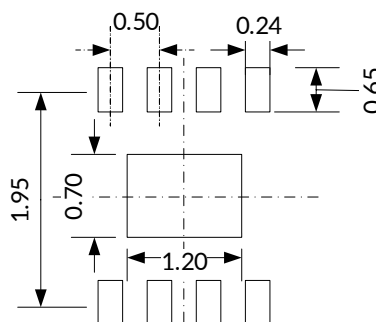

Figure 38. Layout Recommendation

12 PACKAGE OUTLINE DIMENSIONS

DFN2X2-8 ⁽²⁾



TOP VIEW

BOTTOM VIEW

SIDE VIEW

RECOMMENDED LAND PATTERN
(Unit: mm)

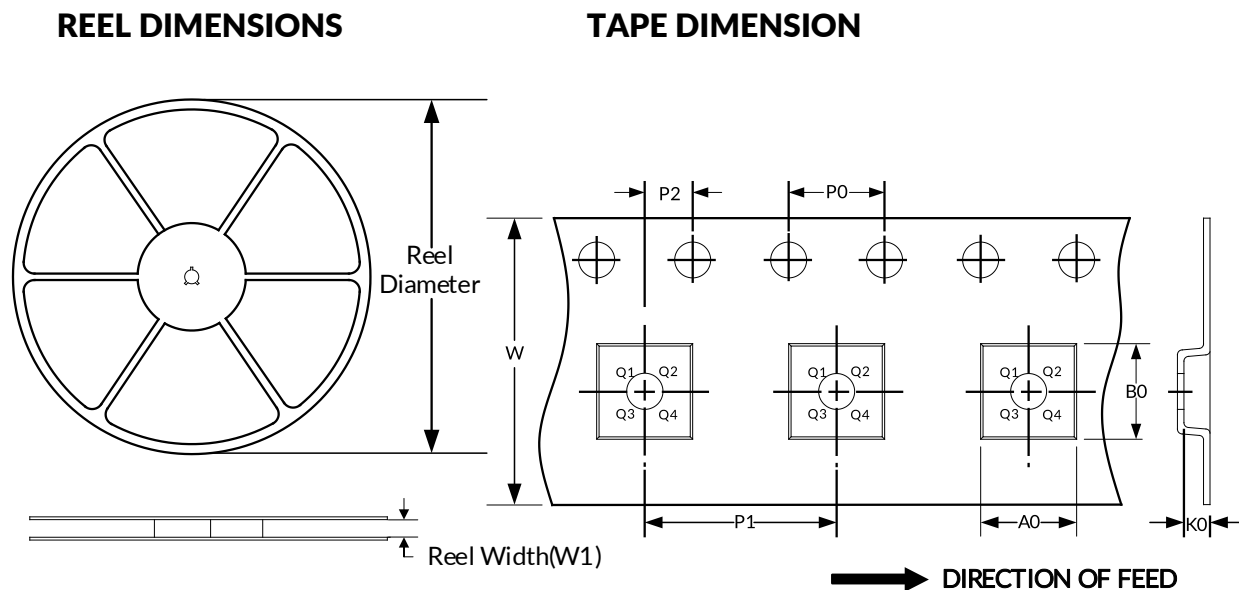
Symbol	Dimensions In Millimeters		Dimensions In Inches	
	Min	Max	Min	Max
A ⁽¹⁾	0.700	0.800	0.028	0.031
A1	0.000	0.050	0.000	0.002
A2	0.203(TYP)		0.008(TYP)	
b	0.180	0.300	0.007	0.012
D ⁽¹⁾	1.900	2.100	0.075	0.083
D1	1.100	1.300	0.043	0.051
E ⁽¹⁾	1.900	2.100	0.075	0.083
E1	0.600	0.800	0.024	0.031
e	0.500(TYP)		0.020(TYP)	
L	0.250	0.450	0.010	0.018

NOTE:

1. Plastic or metal protrusions of 0.075mm maximum per side are not included.
2. This drawing is subject to change without notice.

13 TAPE AND REEL INFORMATION



NOTE: The picture is only for reference. Please make the object as the standard.

KEY PARAMETER LIST OF TAPE AND REEL

Package Type	Reel Diameter	Reel Width (mm)	A0 (mm)	B0 (mm)	K0 (mm)	P0 (mm)	P1 (mm)	P2 (mm)	W (mm)	Pin1 Quadrant
DFN2X2-8	7"	9.5	2.30	2.30	1.10	4.0	4.0	2.0	8.0	Q2

NOTE:

1. All dimensions are nominal.
2. Plastic or metal protrusions of 0.15mm maximum per side are not included.

IMPORTANT NOTICE AND DISCLAIMER

Jiangsu Runic Technology Co., Ltd. will accurately and reliably provide technical and reliability data (including data sheets), design resources (including reference designs), application or other design advice, WEB tools, safety information and other resources, without warranty of any defect, and will not make any express or implied warranty, including but not limited to the warranty of merchantability Implied warranty that it is suitable for a specific purpose or does not infringe the intellectual property rights of any third party.

These resources are intended for skilled developers designing with Runic products You will be solely responsible for: (1) Selecting the appropriate products for your application; (2) Designing, validating and testing your application; (3) Ensuring your application meets applicable standards and any other safety, security or other requirements; (4) Runic and the Runic logo are registered trademarks of Runic Incorporated. All trademarks are the property of their respective owners; (5) For change details, review the revision history included in any revised document. The resources are subject to change without notice. Our company will not be liable for the use of this product and the infringement of patents or third-party intellectual property rights due to its use.